

**Agilent Technologies**  
**N5161A/62A/81A/82A/  
83A**

**MXG Signal Generators**

**User's Guide**



**Agilent Technologies**

# Notices

© Agilent Technologies, Inc. 2006-2010

No part of this manual may be reproduced in any form or by any means (including electronic storage and retrieval or translation into a foreign language) without prior agreement and written consent from Agilent Technologies, Inc. as governed by United States and international copyright laws.

## Manual Part Number

N5180-90003

## Edition

July 2010

Printed in USA

Agilent Technologies, Inc.  
3501 Stevens Creek Blvd.  
Santa Clara, CA 95052 USA

## Warranty

**The material contained in this document is provided “as is,” and is subject to being changed, without notice, in future editions. Further, to the maximum extent permitted by applicable law, Agilent disclaims all warranties, either express or implied, with regard to this manual and any information contained herein, including but not limited to the implied warranties of merchantability and fitness for a particular purpose. Agilent shall not be liable for errors or for incidental or consequential damages in connection with the furnishing, use, or performance of this document or of any information contained herein. Should Agilent and the user have a separate written agreement with warranty terms covering the material in this document that conflict with these terms, the warranty terms in the separate agreement shall control.**

## Technology Licenses

The hardware and/or software described in this document are furnished under a license and may be used or copied only in accordance with the terms of such license.

## Restricted Rights Legend

U.S. Government Restricted Rights. Software and technical data rights granted to the federal government include only those rights customarily provided to end user customers. Agilent provides this customary commercial license in Software and technical data pursuant to FAR 12.211 (Technical Data) and 12.212 (Computer Software) and, for the Department of Defense, DFARS 252.227-7015 (Technical Data - Commercial Items) and DFARS 227.7202-3 (Rights in Commercial Computer Software or Computer Software Documentation).

## Safety Notices

### CAUTION

A **CAUTION** notice denotes a hazard. It calls attention to an operating procedure, practice, or the like that, if not correctly performed or adhered to, could result in damage to the product or loss of important data. Do not proceed beyond a **CAUTION** notice until the indicated conditions are fully understood and met.

---

### WARNING

A **WARNING** notice denotes a hazard. It calls attention to an operating procedure, practice, or the like that, if not correctly performed or adhered to, could result in personal injury or death. Do not proceed beyond a **WARNING** notice until the indicated conditions are fully understood and met.

---

**1 Signal Generator Overview**

Signal Generator Features . . . . . 2

Modes of Operation . . . . . 4

    Continuous Wave . . . . . 4

    Swept Signal . . . . . 4

    Analog Modulation . . . . . 4

    Digital Modulation (N5162A/82A with Options 651, 652, or 654 Only) . . . . . 4

Front Panel Overview – N5181A/82A MXG . . . . . 5

    1. Host USB . . . . . 5

    2. Display . . . . . 5

    3. Softkeys . . . . . 5

    4. Numeric Keypad . . . . . 6

    5. Arrows and Select. . . . . 6

    6. Page Up . . . . . 6

    7. MENUS . . . . . 6

    8. Trigger . . . . . 6

    9. Local Cancel/(Esc) . . . . . 6

    10. Help . . . . . 7

    11. Preset and User Preset. . . . . 7

    12. RF Output . . . . . 7

    13. RF On/Off and LED. . . . . 7

    14. Mod On/Off and LED. . . . . 7

    15. Page Down. . . . . 7

    16. I Input (vector models only) . . . . . 7

    17. Q Input (vector models only). . . . . 8

    18. Knob. . . . . 8

    19. Incr Set . . . . . 8

    20. Return . . . . . 8

    21. More and LED . . . . . 8

    22. Power Switch and LEDs . . . . . 8

Front Panel Overview – N5161A/62A MXG ATE . . . . . 9

    N5161A/62A MXG ATE Front Panel Functions. . . . . 9

    1. Host USB . . . . . 9

    2. Power Switch and LEDs. . . . . 10

    3. LAN LED . . . . . 10

    4. 1588 LED . . . . . 10

    5. ERROR LED. . . . . 10

    6. LAN Reset Hardkey . . . . . 10

Front Panel Display – N5181A/82A/83A MXG . . . . . 11

    1. Active Function Area. . . . . 11

    2. Frequency Area . . . . . 11

---

# Contents

3. Annunciators . . . . .	11
4. Amplitude Area . . . . .	12
5. Error Message Area . . . . .	13
6. Text Area . . . . .	13
7. Softkey Label Area . . . . .	13
Blank Front Panel Display – N5161A/62A MXG ATE . . . . .	13
N5161A/62A MXG ATE – Web Enabled Display . . . . .	13
Annunciators. . . . .	13
Rear Panel Overview – N5161A/62A <sup>1</sup> /81A/82A MXG . . . . .	15
1. AC Power Receptacle. . . . .	15
2. SWEEP OUT . . . . .	15
. . . . .	16
4. FM . . . . .	16
5. PULSE . . . . .	16
6. TRIG IN . . . . .	16
7. TRIG OUT. . . . .	16
8. REF IN. . . . .	17
9. 10 MHz OUT . . . . .	17
10. GPIB . . . . .	17
11. LAN. . . . .	17
12. Device USB . . . . .	17
Digital Modulation Connectors (Vector Models Only). . . . .	18
I OUT, Q OUT, OUT, OUT . . . . .	18
EXT CLK . . . . .	18
EVENT 1 . . . . .	19
PAT TRIG. . . . .	19
DIGITAL BUS I/O . . . . .	19
AUX I/O. . . . .	20
Rear Panel Overview – N5183A MXG . . . . .	21
1. AC Power Receptacle. . . . .	21
2. SWEEP OUT . . . . .	21
3. AM . . . . .	22
4. FM . . . . .	22
5. PULSE . . . . .	22
6. TRIG IN . . . . .	22
7. TRIG OUT. . . . .	22
8. REF IN. . . . .	22
9. 10 MHz OUT . . . . .	23
10. GPIB . . . . .	23
11. LAN. . . . .	23
12. Device USB . . . . .	23

13. Z AXIS OUTPUT . . . . .	23
14. ALC INPUT . . . . .	24
<b>2 Setting Preferences &amp; Enabling Options</b>	
User Preferences . . . . .	26
Display Settings . . . . .	26
Power On and Preset . . . . .	27
Front Panel Knob Resolution . . . . .	28
Setting Time and Date. . . . .	28
Reference Oscillator Tune . . . . .	29
Upgrading Firmware . . . . .	29
Remote Operation Preferences . . . . .	30
GPIB Address and Remote Language . . . . .	30
Configuring the LAN Interface . . . . .	31
Enabling LAN Services: “Browser,” “Sockets,” “VXI-11” and “LXI-B” . . . . .	32
Configuring the Remote Languages . . . . .	33
Configuring the Preset Languages . . . . .	35
Enabling an Option . . . . .	37
Viewing Options and Licenses. . . . .	38
Hardware Assembly Installation and Removal Softkeys. . . . .	39
Hardware Assembly Installation and Removal Softkeys. . . . .	39
<b>3 Basic Operation</b>	
Presetting the Signal Generator. . . . .	42
Viewing Key Descriptions. . . . .	42
Entering and Editing Numbers and Text. . . . .	43
Entering Numbers and Moving the Cursor. . . . .	43
Entering Alpha Characters . . . . .	43
Example: Using a Table Editor . . . . .	44
Setting Frequency and Power (Amplitude) . . . . .	45
Example: Configuring a 700 MHz, -20 dBm Continuous Wave Output. . . . .	46
Using an External Reference Oscillator. . . . .	46
Setting ALC Bandwidth Control . . . . .	47
Configuring a Swept Output. . . . .	48
Routing Signals . . . . .	50
Step Sweep . . . . .	50
List Sweep . . . . .	56
Example: Using a Single Sweep. . . . .	59
Example: Manual Control of Sweep . . . . .	60

---

# Contents

Modulating the Carrier Signal . . . . .	60
Example. . . . .	60
Simultaneous Modulation. . . . .	62
Working with Files. . . . .	62
File Softkeys . . . . .	63
Viewing a List of Stored Files . . . . .	64
Storing a File . . . . .	65
Loading (Recalling) a Stored File . . . . .	67
Moving a File from One Media to Another . . . . .	68
Working with Instrument State Files . . . . .	69
Selecting the Default Storage Media. . . . .	73
Reading Error Messages . . . . .	74
Error Message Format. . . . .	74
<b>4 Using Analog Modulation (Option UNT Only)</b>	
The Basic Procedure . . . . .	76
Using an External Modulation Source . . . . .	77
Removing a DC Offset. . . . .	77
Using Wideband AM. . . . .	77
<b>5 Optimizing Performance</b>	
Using the Dual Power Meter Display . . . . .	80
Example: Dual Power Meter Calibration . . . . .	83
Using Flatness Correction . . . . .	88
Creating a User Flatness Correction Array . . . . .	90
Recalling and Applying a User Flatness Correction Array . . . . .	96
Using Internal Channel Correction—(Requires Option U01 or Greater) . . . . .	97
Configure Internal Channel Correction. . . . .	98
Using I/Q Mod Skew Cal. . . . .	99
Using External Leveling (N5183A Only) . . . . .	102
Option 1E1 Output Attenuator Behavior and Use. . . . .	105
Configure External Leveling. . . . .	106
Using Unleveled Operating Modes . . . . .	110
ALC Off Mode. . . . .	110
Power Search Mode . . . . .	111
Using an Output Offset, Reference, or Multiplier . . . . .	113
Setting an Output Offset . . . . .	113
Setting an Output Reference. . . . .	114
Setting a Frequency Multiplier . . . . .	115
Using the Frequency and Phase Reference Softkeys . . . . .	117

Using Free Run, Step Dwell, and Timer Trigger . . . . .	117
Understanding Free Run, Step Dwell, and Timer Trigger Setup . . . . .	118
Using LXI (Option ALB) . . . . .	120
Understanding LXI Clocks . . . . .	120
Getting Started With LXI . . . . .	122
For More Information . . . . .	125
Using a USB Keyboard . . . . .	126
<b>6 Using Pulse Modulation (Option UNU or UNW or 320)</b>	
Pulse Characteristics . . . . .	129
The Basic Procedure . . . . .	131
Example . . . . .	131
Pulse Train (Option 320 – Requires: Option UNU or UNW) . . . . .	132
<b>7 Basic Digital Operation—No BBG Option Installed</b>	
I/Q Modulation . . . . .	138
Configuring the Front Panel Inputs . . . . .	139
<b>8 Basic Digital Operation (Option 651/652/654)</b>	
Waveform File Basics . . . . .	142
Signal Generator Memory . . . . .	142
Dual ARB Player . . . . .	142
Storing, Loading, and Playing a Waveform Segment . . . . .	144
Loading a Waveform Segment into BBG Media . . . . .	144
Storing/Renaming a Waveform Segment to Internal or USB Media . . . . .	145
Playing a Waveform Segment . . . . .	145
Waveform Sequences . . . . .	147
Creating a Sequence . . . . .	148
Viewing the Contents of a Sequence . . . . .	149
Editing a Sequence . . . . .	149
Playing a Sequence . . . . .	150
Saving a Waveform’s Settings & Parameters . . . . .	151
Viewing and Modifying Header Information . . . . .	153
Viewing & Editing a Header without Selecting the Waveform . . . . .	155
Using Waveform Markers . . . . .	157
Waveform Marker Concepts . . . . .	158
Accessing Marker Utilities . . . . .	162

---

# Contents

Viewing Waveform Segment Markers . . . . .	163
Clearing Marker Points from a Waveform Segment . . . . .	163
Setting Marker Points in a Waveform Segment . . . . .	164
Viewing a Marker Pulse . . . . .	167
Using the RF Blanking Marker Function . . . . .	168
Setting Marker Polarity . . . . .	170
Controlling Markers in a Waveform Sequence . . . . .	170
Using the EVENT Output Signal as an Instrument Trigger . . . . .	173
Triggering a Waveform . . . . .	174
Trigger Type . . . . .	175
Trigger Source . . . . .	176
Example: Segment Advance Triggering . . . . .	177
Example: Gated Triggering . . . . .	178
Example: External Triggering . . . . .	180
Clipping a Waveform . . . . .	181
How Power Peaks Develop . . . . .	182
How Peaks Cause Spectral Regrowth . . . . .	184
How Clipping Reduces Peak-to-Average Power . . . . .	185
Configuring Circular Clipping . . . . .	188
Configuring Rectangular Clipping . . . . .	189
Scaling a Waveform . . . . .	190
How DAC Over-Range Errors Occur . . . . .	191
How Scaling Eliminates DAC Over-Range Errors . . . . .	192
Setting Waveform Runtime Scaling . . . . .	193
Setting Waveform Scaling . . . . .	194
Setting the Baseband Frequency Offset . . . . .	196
DAC Over-Range Conditions and Scaling . . . . .	198
I/Q Modulation . . . . .	200
Using the Rear Panel I and Q Outputs . . . . .	201
Configuring the Front Panel Inputs . . . . .	202
I/Q Adjustments . . . . .	203
I/Q Calibration . . . . .	205
Using the Equalization Filter . . . . .	207
Using Finite Impulse Response (FIR) Filters in the Dual ARB Real-Time Modulation Filter . . . . .	209
Creating a User-Defined FIR Filter Using the FIR Table Editor . . . . .	210
Modifying a FIR Filter Using the FIR Table Editor . . . . .	215
Loading the Default Gaussian FIR File . . . . .	216
Modifying the Coefficients . . . . .	217
Storing the Filter to Memory . . . . .	218
Setting the Real-Time Modulation Filter . . . . .	219



Multiple Baseband Generator Synchronization . . . . .	220
Understanding the Master/Slave System . . . . .	223
Equipment Setup . . . . .	224
Configuring the Setup . . . . .	224
Making Changes to the Multiple Synchronization Setup and Resynchronizing the Master/Slave System . . . . .	226
Understanding Option 012 (LO In/Out for Phase Coherency) with Multiple Baseband Generator Synchronization . . . . .	227
Configuring the Option 012 (LO In/Out for Phase Coherency) with MIMO. . . . .	227
Waveform Licensing for Firmware Version $\geq$ A.01.50. . . . .	231
Understanding Waveform Licensing . . . . .	231
Installing an Option N5182-22x or Option N5182A-25x . . . . .	231
Licensing a Signal Generator Waveform . . . . .	231
Waveform 5-Pack Licensing (Options 221-229) for Firmware Version $<$ A.01.50. . . . .	239
Understanding Waveform 5-Pack Licensing . . . . .	239
Installing an Option N5182A-22x Waveform 5-Pack Licensing. . . . .	239
Licensing a Signal Generator Waveform File . . . . .	240
Waveform 5-Pack Licensing Softkeys Overview. . . . .	240
Using Waveform 5-Pack History . . . . .	246
Waveform 5-Pack Warning Messages . . . . .	250
<b>9 Adding Real-Time Noise to a Signal (Option 403)</b>	
Adding Real-Time Noise to a Dual ARB Waveform. . . . .	251
Eb/No Adjustment Softkeys for Real Time I/Q Baseband AWGN . . . . .	254
Using Real Time I/Q Baseband AWGN . . . . .	257
<b>10 Real-Time Phase Noise Impairments (Option 432)</b>	
Real-Time Phase Noise Impairment. . . . .	260
The Agilent MXG Phase Noise Shape and Additive Phase Noise Impairments . . . . .	261
Understanding the Phase Noise Adjustments . . . . .	263
DAC Over-Range Conditions and Scaling . . . . .	264
<b>11 Custom Digital Modulation (Option 431)</b>	
Custom Modulation . . . . .	266
ARB Custom Modulation Waveform Generator . . . . .	266
Using the Arbitrary Waveform Generator . . . . .	271
Using Predefined Custom TDMA Digital Modulation . . . . .	271
Creating a Custom TDMA Digital Modulation State. . . . .	273
Storing a Custom TDMA Digital Modulation State. . . . .	275
Recalling a Custom TDMA Digital Modulation State . . . . .	277

---

# Contents

Creating a Custom Multicarrier TDMA Digital Modulation State . . . . .	278
Storing a Custom Multicarrier TDMA Digital Modulation State . . . . .	280
Applying Changes to an Active Multicarrier TDMA Digital Modulation State . . . . .	280
Using Finite Impulse Response (FIR) Filters in ARB Custom Modulation . . . . .	281
Creating a User-Defined FIR Filter Using the FIR Table Editor . . . . .	281
Modifying a FIR Filter Using the FIR Table Editor. . . . .	286
Loading the Default Gaussian FIR File. . . . .	287
Modifying the Coefficients . . . . .	288
Storing the Filter to Memory . . . . .	289
Differential Encoding . . . . .	289
Using Differential Encoding . . . . .	293
<b>12 Multitone and Two-Tone Waveforms (Option 430)</b>	
Creating a Custom Two-Tone Waveform. . . . .	297
Creating a Custom Multitone Waveform . . . . .	297
Using Two-Tone Modulation . . . . .	298
Two-Tone Modulation Softkeys . . . . .	299
Creating a Two-Tone Waveform . . . . .	299
Viewing a Two-Tone Waveform. . . . .	300
Minimizing Carrier Feedthrough . . . . .	301
Changing the Alignment of a Two-Tone Waveform . . . . .	302
Using Multitone Modulation . . . . .	304
Multitone Modulation Softkeys . . . . .	304
Initializing the Multitone Setup Table Editor. . . . .	304
Configuring Tone Powers and Tone Phases . . . . .	305
Removing a Tone . . . . .	305
Generating the Waveform. . . . .	305
Configuring the RF Output . . . . .	306
Applying Changes to an Active Multitone Signal . . . . .	306
<b>13 Working in a Secure Environment</b>	
Understanding Memory Types . . . . .	309
Removing Data from Memory (Option 006 Only) . . . . .	312
Erase All . . . . .	312
Erase and Overwrite All . . . . .	313
Erase and Sanitize All . . . . .	313
Removing Persistent State Information Not Removed During Erase . . . . .	313
Secure Mode . . . . .	314
Securing a Nonfunctioning Instrument . . . . .	314
Using the Secure Display (Option 006 Only) . . . . .	315

**14 Troubleshooting**

Display . . . . . 318

    The Display is Too Dark to Read . . . . . 318

    The Display Turns Black when Using USB Media . . . . . 318

Signal Generator Lock-Up . . . . . 318

RF Output . . . . . 318

    No RF Output . . . . . 318

    Power Supply Shuts Down . . . . . 318

    No Modulation at the RF Output . . . . . 318

    RF Output Power too Low . . . . . 319

    Distortion . . . . . 319

    Signal Loss While Working with a Spectrum Analyzer . . . . . 319

    Signal Loss While Working with a Mixer . . . . . 320

Sweep . . . . . 322

    Cannot Turn Off Sweep . . . . . 322

    Sweep Appears Stalled . . . . . 322

    Incorrect List Sweep Dwell Time . . . . . 322

    List Sweep Information is Missing from a Recalled Register . . . . . 322

    Amplitude Does Not Change in List or Step Sweep . . . . . 322

Internal Media Data Storage . . . . . 323

    Instrument State Saved but the Register is Empty or Contains the Wrong State . . . . . 323

USB Media Data Storage . . . . . 323

    Instrument Recognizes USB Media Connection, but Does Not Display Files . . . . . 323

Preset . . . . . 323

    The Signal Generator Does Not Respond . . . . . 323

    Pressing Preset Performs a User Preset . . . . . 323

Error Messages . . . . . 324

    Error Message Types . . . . . 324

    Error Message File . . . . . 324

Front Panel Tests . . . . . 325

Self Test Overview . . . . . 326

Licenses . . . . . 328

    A Time-Based License Quits Working . . . . . 328

    Cannot Load a Time-Based License . . . . . 328

Contacting Agilent Technologies . . . . . 328

    Returning a Signal Generator to Agilent . . . . . 328

---

# Contents

# Documentation Overview

## Installation Guide

- Safety Information
- Receiving the Instrument
- Environmental & Electrical Requirements
- Basic Setup
- Accessories
- Operation Verification
- Regulatory Information

## User's Guide

- Signal Generator Overview
- Setting Preferences & Enabling Options
- Basic Operation
- Optimizing Performance
- Using Analog Modulation (Option UNT Only)
- Using Pulse Modulation (Option UNU Only)
- Basic Digital Operation – No BBG Option Installed
- Basic Digital Operation (Option 651/652/654)
- Adding Real-Time Noise to a Signal (Option 403)
- Real-Time Phase Noise Impairments (Option 432)
- Custom Digital Modulation (Option 431)
- Multitone and Two-Tone Waveform Generator (Option 430)
- Working in a Secure Environment
- Troubleshooting

## Programming Guide

- Getting Started with Remote Operation
- Using IO Interfaces
- Programming Examples
- Programming the Status Register System
- Creating and Downloading Files
- Creating and Downloading User-Data Files

**SCPI Reference**

- SCPI Basics
- Basic Function Commands
- LXI System Commands
- System Commands
- Analog Modulation Commands
- Arb Commands
- Real-Time Commands
- N5161A/62A/81A/82A SCPI Command Compatibility
- N5183A SCPI Command Compatibility

**Service Guide**

- Troubleshooting
- Replaceable Parts
- Assembly Replacement
- Post-Repair Procedures
- Safety and Regulatory Information
- Instrument History

**Key Help<sup>a</sup>**

- Key function description
- Related SCPI commands

<sup>a</sup>Press the **Help** hardkey, and then the key for which you wish help.

---

# 1 Signal Generator Overview

---

**CAUTION** To avoid damaging or degrading the performance of the MXG, do not exceed 33 dBm (2W) *maximum* of reverse power levels at the RF input. See also *Tips for Preventing Signal Generator Damage* on [www.agilent.com](http://www.agilent.com).

---

**NOTE** The N5161A/62A MXG ATE is identical to the N5181A/82A with the exception that they do not have front panel functionality (no display or keys). Instead all functionality is controlled through SCPI commands or the Web-Enabled MXG. For signal generator functionality, refer to the *Users Guide*. For information on the Web-Enabled MXG, refer to the *Installation Guide*, the *Programming Guide* and the *SCPI Command Reference*.

MXG ATE blank front panel models, N5161A and N5162A signal generators, are part of the MXG instrument family and unless otherwise indicated, all references to the MXG are inclusive of the MXG ATE instruments.

Full Option ALB LXI-B feature implementation is only available on instruments with firmware  $\geq$ A.01.50. A license may be required to enable this feature and to download firmware versions  $\geq$ A.01.50. For information on new firmware releases, go to <http://www.agilent.com/find/upgradeassistant>.

---

- [Signal Generator Features](#) on page 2
- [Modes of Operation](#) on page 4
- [Front Panel Overview – N5181A/82A MXG](#) on page 5
- [Front Panel Overview – N5161A/62A MXG ATE](#) on page 9
- [Front Panel Display – N5181A/82A/83A MXG](#) on page 11
- [Blank Front Panel Display – N5161A/62A MXG ATE](#) on page 13
- [Rear Panel Overview – N5161A/62A<sup>1</sup>/81A/82A MXG](#) on page 15

## Signal Generator Features

- N5161A<sup>1</sup>/N5181A, RF analog models: 100 kHz to 1<sup>2</sup>, 3, or 6 GHz (Options 501<sup>2</sup>, 503, and 506 respectively)
- N5162A<sup>1</sup>/N5182A, RF vector models: 100 kHz to 3 or 6 GHz (Options 503, and 506 respectively)
- N5183A, Microwave analog model: 100 kHz to 20, 31.8, or 40 GHz (Options 520, 532, and 540 respectively)
- electronic attenuator (N5161A/62A/81A/82A only)
- mechanical attenuator (N5183A with Option 1E1 only)
- step & list sweep of frequency, power, or frequency and power
- vector models can include waveforms in list sweep
- pulse modulation (Option UNU)
- narrow pulse modulation (Option UNW)
- analog differential I/Q outputs (vector models, Option 1EL)
- analog modulation: AM, FM, and  $\Phi$ M (Option UNT)
- arbitrary I/Q waveform playback up to 125 MSa/s (vector models, Option 654)
- automatic leveling control (ALC); power calibration
- bandwidth control (ALC)
- deep amplitude modulation providing greater dynamic range
- enhanced assembly replacement
- external AM, FM, and  $\Phi$ M inputs (Option UNT)
- external analog I/Q inputs (vector models)
- Wideband AM (vector models, Option UNT)
- flexible reference input, 1 – 50 MHz (Option 1ER)
- GPIB, USB 2.0, and 100Base-T LAN interfaces
- improved signal to noise ratio
- LO In/Out (Option 012)
- LXI is supported (Option ALB)
- Digital Bus I/O compatibility with the PXB
- manual power search (ALC off) (Option 099 *and or* instruments starting with serial numbers 4818 and greater)
- multiple baseband generator synchronization when using multiple signal generators (master/slave setup)
- narrow pulse modulation (Option UNW)

<sup>1</sup>The N5161A/62A – Automated Test Equipment (ATE) have a blank front panel (i.e. no front panel display, hardkeys or softkeys).

<sup>2</sup>Option 501 is not applicable to the N5161A.



- phase noise interference (vector models, Option 432)
- internal channel correction (vector models, Option U01)
- SCPI and IVI-COM driver
- user flatness correction
- user settable maximum power limit
- two channel power meter display
- 10 MHz reference oscillator with external output
- 8648/ESG code compatible
- real-time modulation filtering
- with Signal Studio Software, vector models can generate 802.11 WLAN, W-CDMA, cdma2000, 1xEV-DO, GSM, EDGE, and more

For more details on hardware, firmware, software, and documentation features and options, refer to the data sheet shipped with the signal generator and available from the Agilent Technologies website.

1. Open: <http://www.agilent.com/find/mxg>
2. Select the desired model number.
3. In the options and price list section, click **price list**.

## Modes of Operation

Depending on the model and installed options, the Agilent MXG signal generator provides up to four basic modes of operation: continuous wave (CW), swept signal, analog modulation, and digital modulation.

### Continuous Wave

In this mode, the signal generator produces a continuous wave signal. The signal generator is set to a single frequency and power level. Both the N5161A/81A and N5162A/82A can produce a CW signal.

### Swept Signal

In this mode, the signal generator sweeps over a range of frequencies and/or power levels. Both the N5161A/81A and N5162A/82A provide list and step sweep functionality.

### Analog Modulation

In this mode, the signal generator modulates a CW signal with an analog signal. The analog modulation types available depend on the installed options.

Option UNT provides AM, FM, and  $\Phi$ M modulations. Some of these modulations can be used together.

---

**NOTE** The Mod On/Off hardkey and LED functionality are only valid for MXGs with Option UNT installed.

Refer to [14. Mod On/Off and LED](#).

---

Options UNU and UNW provide standard and narrow pulse modulation capability, respectively.

### Digital Modulation (N5162A/82A with Options 651, 652, or 654 Only)

---

**NOTE** The internal baseband generator speed upgrade Options 670, 671, and 672 are option upgrades that *require* Option 651 and 652 to have been loaded at the factory (refer to the *Data Sheet* for more information). Any references to 651, 652, or 654 are inclusive of 671, 672, and 674.

---

In this mode, the signal generator modulates a CW signal with a arbitrary I/Q waveform. I/Q modulation is only available on the N5162A/82A. An internal baseband generator (Option 651, 652, or 654) adds the following digital modulation formats:

- *Custom Arb Waveform Generator* mode can produce a single-modulated carrier or multiple-modulated carriers. Each modulated carrier waveform must be calculated and generated before it can be output; this signal generation occurs on the internal baseband generator. Once a waveform has been created, it can be stored and recalled, which enables repeatable playback of test signals. To learn more, refer to [“Using the Arbitrary Waveform Generator” on page 271](#).
- *Multitone* mode produces up to 64 continuous wave signals (or tones). Like the Two Tone mode, the frequency spacing between the signals and the amplitudes are adjustable. To learn more, refer to [“Creating a Custom Multitone Waveform” on page 297](#).

- *Two-tone* mode produces two separate continuous wave signals (or tones). The frequency spacing between the signals and the amplitudes are adjustable. To learn more, refer to [Chapter 12, "Multitone and Two-Tone Waveforms \(Option 430\)"](#).
- *Dual ARB* mode is used to control the playback sequence of waveform segments that have been written into the ARB memory located on the internal baseband generator. These waveforms can be generated by the internal baseband generator using the Custom Arb Waveform Generator mode, or downloaded through a remote interface into the ARB memory. To learn more, refer to ["Dual ARB Player"](#) on page 142.

## Front Panel Overview – N5181A/82A MXG

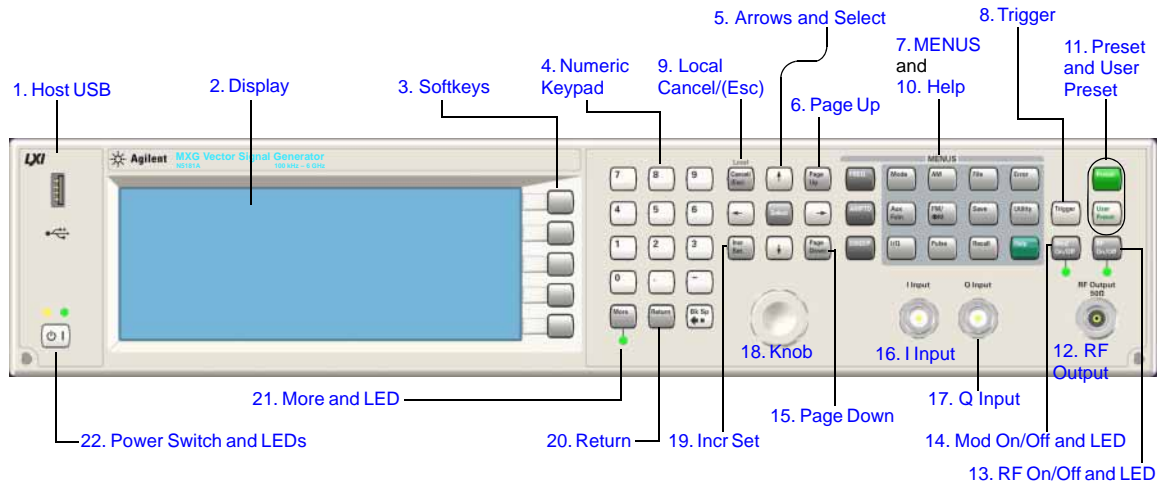

### 1. Host USB

**Connector** Type A  
**USB Protocol** 2.0

Use this universal serial bus (USB) to connect a USB Flash Drive (UFD) for data transfer. You can connect or disconnect a USB device without shutting down or restarting the signal generator. The instrument also has a rear panel device USB connector (see [page 17](#)) used to remotely control the instrument.

### 2. Display

The LCD screen provides information on the current function. Information can include status indicators, frequency and amplitude settings, and error messages. Labels for the softkeys are located on the right hand side of the display. See also, ["Front Panel Display – N5181A/82A/83A MXG"](#) on page 11.

### 3. Softkeys

A softkey activates the function indicated by the displayed label to the left of the key.

## 4. Numeric Keypad

The numeric keypad comprises the 0 through 9 hardkeys, a decimal point hardkey, a minus sign hardkey, and a backspace hardkey. See “Entering and Editing Numbers and Text” on page 43.

## 5. Arrows and Select

The **Select** and arrow hardkeys enable you to select items on the signal generator’s display for editing. See “Entering and Editing Numbers and Text” on page 43.

## 6. Page Up

In a table editor, use this hardkey to display a previous page. See “Example: Using a Table Editor” on page 44. When text does not fit on one page in the display area, use this key in conjunction with the **Page Down** key (page 7) to scroll text.

## 7. MENUS

These hardkeys open softkey menus that enable you to configure instrument functions or access information.

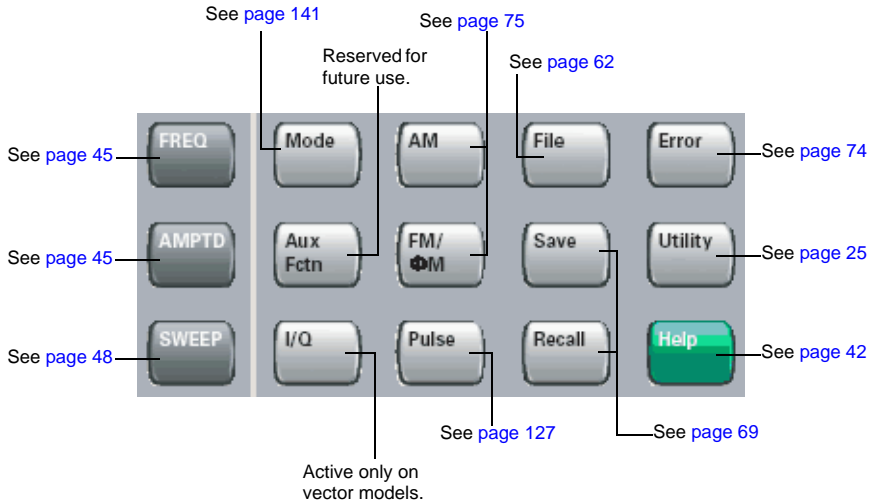

## 8. Trigger

When trigger mode is set to **Trigger Key**, this hardkey initiates an immediate trigger event for a function such as a list or step sweep.

## 9. Local Cancel/(Esc)

This hardkey deactivates remote operation and returns the signal generator to front panel control, cancels an active function entry, and cancels long operations (such as an IQ calibration).

## 10. Help

Use this key to display a description of any hardkey or softkey. See [“Viewing Key Descriptions” on page 42.](#)

## 11. Preset and User Preset

These hardkeys set the signal generator to a known state (factory or user-defined). See [“Presetting the Signal Generator” on page 42.](#)

## 12. RF Output

<b>Connector</b>	Standard:	female Type-N
	Option 1EM:	Rear panel female Type-N
	Impedance:	50 Ω
<b>Damage Levels</b>	50 Vdc, 2 W maximum RF power	

## 13. RF On/Off and LED

This hardkey toggles the operating state of the RF signal present at the RF OUTPUT connector. The **RF On/Off** LED lights when RF output is enabled.

## 14. Mod On/Off and LED

This hardkey enables or disables the modulation of the output carrier signal by an active modulation format. This hardkey does not set up or activate a format (see [“Modulating the Carrier Signal” on page 60.](#))

The **MOD ON/OFF** LED lights when modulation of the output is enabled.

---

**NOTE** The Mod On/Off hardkey and LED functionality are only valid for MXGs with Option UNT installed.

---

## 15. Page Down

In a table editor, use this hardkey to display the next page. See [“Example: Using a Table Editor” on page 44.](#) When text does not fit on one page in the display area, use this key in conjunction with the **Page Up** key ([page 6](#)) to scroll text.

## 16. I Input (vector models only)

<b>Connector</b>	Type: female BNC	Impedance: 50 Ω
<b>Signal</b>	An externally supplied analog, in-phase component of I/Q modulation.	
	The signal level is $\sqrt{I^2+Q^2} = 0.5 V_{\text{rms}}$ for a calibrated output level.	
<b>Damage Levels</b>	1 V <sub>rms</sub>	

See also, [“I/Q Modulation” on page 200.](#)

## 17. Q Input (vector models only)

**Connector** Type: female BNC Impedance: 50  $\Omega$

**Signal** An externally supplied analog, quadrature-phase component of I/Q modulation.

The signal level is  $\sqrt{I^2+Q^2} = 0.5 V_{\text{rms}}$  for a calibrated output level.

**Damage Levels** 1  $V_{\text{rms}}$

See also, “[I/Q Modulation](#)” on page 200.

## 18. Knob

Rotating the knob increases or decreases a numeric value, or moves the highlight to the next digit, character, or item in a list. See also, “[Front Panel Knob Resolution](#)” on page 28.

## 19. Incr Set

This hardkey enables you to set the increment value of the currently active function. The increment value also affects how much each turn of the knob changes an active function’s value, according to the knob’s current ratio setting (see “[Front Panel Knob Resolution](#)” on page 28).

## 20. Return

This hardkey enables you to retrace key presses. In a menu with more than one level, the **Return** key returns to the prior menu page.

## 21. More and LED

When a menu contains more softkey labels than can be displayed, the More LED lights and a More message displays below the labels. To display the next group of labels, press the **More** hardkey.

## 22. Power Switch and LEDs

This switch selects the standby mode or the power on mode. In the standby position, the yellow LED lights and all signal generator functions deactivate. The signal generator remains connected to the line power, and some power is consumed by some internal circuits. In the on position, the green LED lights and the signal generator functions activate.

## Front Panel Overview – N5161A/62A MXG ATE

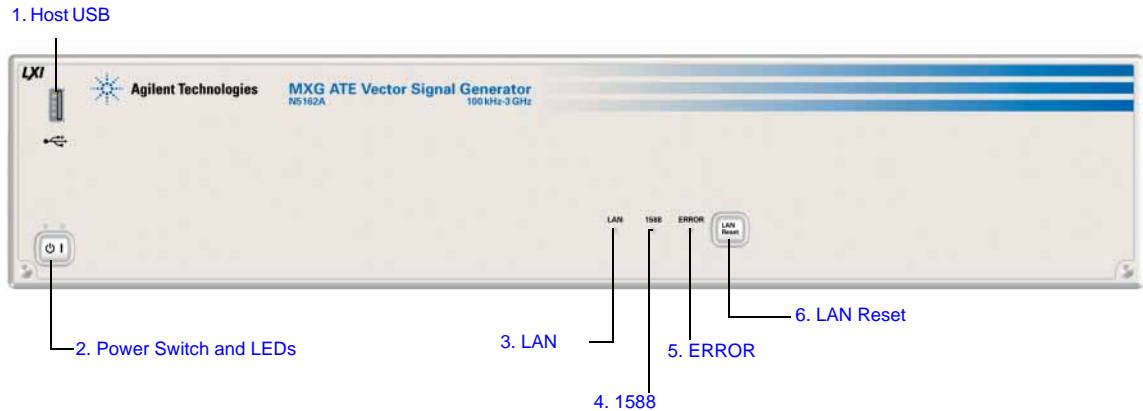

### N5161A/62A MXG ATE Front Panel Functions

The MXG ATE is identical to an MXG with a front panel display, except that the front panel, hardkeys and softkeys functionality are only available through SCPI commands or the Web-Enabled MXG. For information on the Web-Enabled MXG, refer to the *Installation Guide*, the *Programming Guide* and the *SCPI Command Reference*.

Functions unique to the MXG ATE:

- LAN LED ([page 10](#)).
- 1588 LED ([page 10](#)).
- ERROR LED ([page 10](#)).
- LAN Reset Hardkey ([page 10](#)).

For more information, refer to the *Service Guide*.

#### 1. Host USB

**Connector** Type A

**USB Protocol** 2.0

Use this universal serial bus (USB) to connect a USB Flash Drive (UFD) for data transfer. You can connect or disconnect a USB device without shutting down or restarting the signal generator. The instrument also has a rear panel device USB connector (see [page 17](#)) used to remotely control the instrument.

## 2. Power Switch and LEDs

This switch selects the standby mode or the power on mode. In the standby position, the yellow LED lights and all signal generator functions deactivate. The signal generator remains connected to the line power, and some power is consumed by some internal circuits. In the on position, the green LED lights and the signal generator functions activate.

## 3. LAN LED

The LAN LED is used to indicate the LAN status.

- If the LED is off, the LAN is down.
- If the LED is blinking, the LAN is being configured (1.2 second duty cycle).
- A 400ms duty cycle indicates the instrument has been placed into LAN Identify mode. (Refer to :INPut:LAN[:SET]:IDENtifier command).
- If the LED is solidly lit, the LAN is up and functional.
- If the LED fails to function, refer to the *Service Guide*.

## 4. 1588 LED

The 1588 LED indicates when the instrument is locked to an external 1588 clock.

- If the 1588 green LED is on, a 1588 signal has been detected on the TRIG OUT BNC on the rear panel.
- If the 1588 green LED is off, no 1588 signal is detected on the TRIG OUT BNC on the rear panel.
- If the LED fails to function, refer to the *Service Guide*.

## 5. ERROR LED

The ERROR LED indicates when there are unread errors in the error queue.

- If Auto reboot is disabled, the LED will blink when an exception occurs during power up.
- If the LED fails to function, refer to the *Service Guide*.

## 6. LAN Reset Hardkey

---

**NOTE** This hardkey is enabled for fail-safe and diagnostic mode and should rarely be used. If the LAN Reset hardkey has been pressed and then the power is cycled on the instrument, the web-server will be enabled after reboot.

---

The LAN Reset is used to access the diagnostics mode during power up.

- Refer to the *SCPI Command Reference* for equivalent remote commands.
- If the LAN Reset fails to function, refer to the *Service Guide*.



## Front Panel Display – N5181A/82A/83A MXG

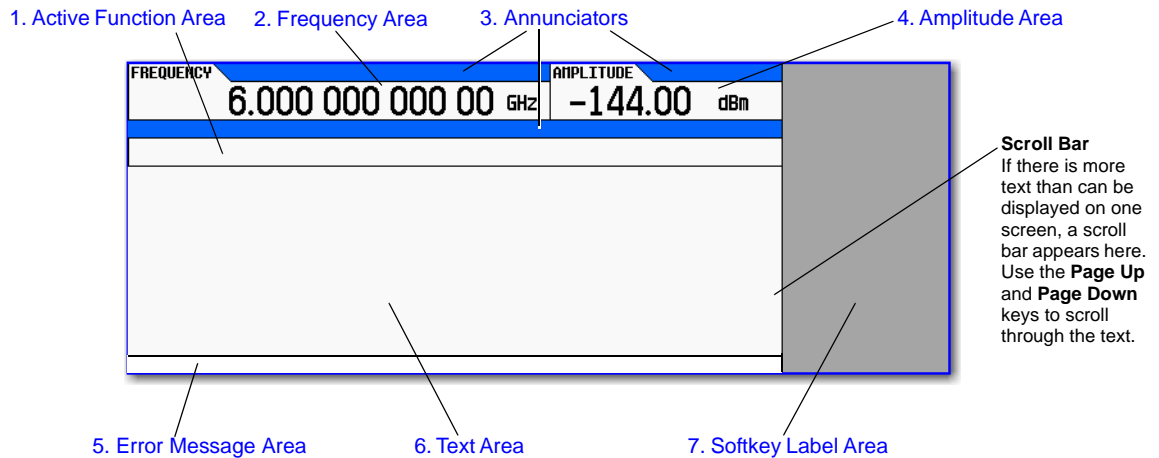

**Scroll Bar**  
 If there is more text than can be displayed on one screen, a scroll bar appears here. Use the **Page Up** and **Page Down** keys to scroll through the text.

### 1. Active Function Area

This area displays the currently active function. For example, if frequency is the active function, the current frequency setting appears. If the currently active function has an increment value associated with it, that value also appears.

### 2. Frequency Area

This area displays the current frequency setting.

### 3. Annunciators

Annunciators show the status of some of the signal generator functions, and indicate error conditions. An annunciator position may be used by more than one annunciator; in this case, only one of the functions sharing a given position can be active at a given time.

This annunciator appears when...	
ΦM	Phase modulation is on. If you turn frequency modulation on, the FM annunciator replaces ΦM.
ARB	The ARB generator is on. ARB is running and not waiting on a trigger.
ALC OFF	The ALC circuit is disabled. The UNLEVEL annunciator appears in the same position if the ALC is enabled and is unable to maintain the output level.
AM	Amplitude modulation is on.
ARMED	A sweep has been initiated and the signal generator is waiting for the sweep trigger event.
ATTNHOLD	The attenuator hold function is on. When this function is on, the attenuator is held at its current setting.
AWGN	Real Time I/Q Baseband additive white Gaussian noise is on.

**This annunciator appears when...**

BEG DAC	A DAC overflow is occurring, adjust the runtime scaling adjust until the BEG DAC annunciator turns off. Another annunciator, UNLOCK, appears in the same position and has priority over the BEG DAC annunciator (see UNLOCK, below).
CHANCORR	The internal channel correction is enabled.
DETHTR	The ALC detector heater is not up to temperature. To meet ALC specifications the heater must be at temperature.
DIGBUS	The digital bus is in use.
DIGMOD	Custom Arb waveform generator is on.
ERR	An error message is placed in the error queue. This annunciator does not turn off until you either view all of the error messages or clear the error queue (see <a href="#">“Reading Error Messages” on page 74</a> ).
EXTREF	An external frequency reference is applied.
FM	Frequency modulation is on. If you turn phase modulation on, the $\Phi$ M annunciator replaces FM.
I/Q	I/Q vector modulation is on.
L	The signal generator is in listener mode and is receiving information or commands over the GPIB, USB, or VXI-11/Sockets (LAN) interface.
M-TONE	Multitone waveform generator is on.
MULT	A frequency multiplier is set (see <a href="#">“Setting a Frequency Multiplier” on page 115</a> ).
OFFS	An output offset is set (see <a href="#">“Setting an Output Offset” on page 113</a> ).
PN	Phase noise interference is on.
PULSE	Pulse modulation is on.
R	The signal generator is remotely controlled over the GPIB, USB, or VXI-11/Sockets (LAN) interface. When the signal generator is in remote mode, the keypad is locked out. To unlock the keypad, press <b>Local</b> .
REF	An output reference is set (see <a href="#">“Setting an Output Reference” on page 114</a> ).
RF OFF	The signal generator’s RF Output is not enabled.
S	The signal generator has generated a service request (SRQ) over the GPIB, USB, or VXI-11/Sockets (LAN) interface.
SWEEP	The signal generator is currently sweeping in list or step mode.
SWMAN	The signal generator is in manual sweep mode.
T	The signal generator is in talker mode and is transmitting information over the GPIB, USB, or VXI-11/Sockets (LAN) interface.
T-TONE	Two-Tone waveform generator is on.
UNLEVEL	The signal generator is unable to maintain the correct output level. This is not necessarily an indication of instrument failure; unlevelled conditions can occur during normal operation. Another annunciator, ALC OFF, appears in the same position when the ALC circuit is disabled (see ALC OFF, above).
UNLOCK	Any of the phase locked loops cannot maintain phase lock. To determine which loop is unlocked, examine the error messages (see <a href="#">“Reading Error Messages” on page 74</a> ).
WATRQ	The current modulation mode is waiting on the Arb trigger.
WINIT	The signal generator is waiting for you to initiate a single sweep.

## 4. Amplitude Area

This area displays the current output power level setting (If the RF Output is off, this area is greyed out).

## 5. Error Message Area

This area displays abbreviated error messages. If multiple messages occur, only the most recent message remains displayed. See “[Reading Error Messages](#)” on page 74.

## 6. Text Area

This area displays signal generator status information, such as the modulation status, and other information such as sweep lists and file catalogs. This area also enables you to perform functions such as managing information (entering information, and displaying or deleting files).

## 7. Softkey Label Area

This area displays labels that define the function of the softkeys located immediately to the right of the display. Softkey labels change, depending on the function selected.

# Blank Front Panel Display – N5161A/62A MXG ATE

## N5161A/62A MXG ATE – Web Enabled Display

The MXG ATE only has display information available through a LAN connection to the Web Server (“[11. LAN](#)” on page 17). For more information on the Web-Enabled MXG, refer to *Programming Guide*.

## Annunciators

---

**NOTE** On the N5161A/62A, the following listing of annunciators are only displayed and visible through the Web-Enabled MXG. Refer to *Programming Guide*, “*Using the Web Browser*”.

---

Annunciators show the status of some of the signal generator functions, and indicate error conditions. An annunciator position may be used by more than one annunciator; in this case, only one of the functions sharing a given position can be active at a given time.

### This annunciator appears when...

ΦM	Phase modulation is on. If you turn frequency modulation on, the FM annunciator replaces ΦM.
ARB	The ARB generator is on. ARB is running and not waiting on a trigger.
ALC OFF	The ALC circuit is disabled. The UNLEVEL annunciator appears in the same position if the ALC is enabled and is unable to maintain the output level.
AM	Amplitude modulation is on.
ARMED	A sweep has been initiated and the signal generator is waiting for the sweep trigger event.
ATTNHOLD	The attenuator hold function is on. When this function is on, the attenuator is held at its current setting.
BEG DAC	A DAC overflow is occurring, adjust the runtime scaling adjust until the BEG DAC annunciator turns off. Another annunciator, UNLOCK, appears in the same position and has priority over the BEG DAC annunciator (see UNLOCK, below).
DETHTR	The ALC detector heater is not up to temperature. To meet ALC specifications the heater must be at temperature.
AWGN	Real Time I/Q Baseband additive white Gaussian noise is on.

**This annunciator appears when...**

DIGBUS	The digital bus is in use.
DIGMOD	Custom Arb waveform generator is on.
ERR	An error message is placed in the error queue. This annunciator does not turn off until you either view all of the error messages or clear the error queue (see <a href="#">“Reading Error Messages” on page 74</a> ).
EXTREF	An external frequency reference is applied.
FM	Frequency modulation is on. If you turn phase modulation on, the $\Phi$ M annunciator replaces FM.
I/Q	I/Q vector modulation is on.
L	The signal generator is in listener mode and is receiving information or commands over the GPIB, USB, or VXI-11/Sockets (LAN) interface.
M-TONE	Multitone waveform generator is on.
MULT	A frequency multiplier is set (see <a href="#">“Setting a Frequency Multiplier” on page 115</a> ).
OFFS	An output offset is set (see <a href="#">“Setting an Output Offset” on page 113</a> ).
PN	Phase noise interference is on.
PULSE	Pulse modulation is on.
R	The signal generator is remotely controlled over the GPIB, USB, or VXI-11/Sockets (LAN) interface. When the signal generator is in remote mode, the keypad is locked out. To unlock the keypad, press <a href="#">Local</a> .
REF	An output reference is set (see <a href="#">“Setting an Output Reference” on page 114</a> ).
RF OFF	The signal generator’s RF Output is not enabled.
S	The signal generator has generated a service request (SRQ) over the GPIB, USB, or VXI-11/Sockets (LAN) interface.
SWEEP	The signal generator is currently sweeping in list or step mode.
SWMAN	The signal generator is in manual sweep mode.
T	The signal generator is in talker mode and is transmitting information over the GPIB, USB, or VXI-11/Sockets (LAN) interface.
T-TONE	Two-Tone waveform generator is on.
UNLEVEL	The signal generator is unable to maintain the correct output level. This is not necessarily an indication of instrument failure; unlevelled conditions can occur during normal operation. Another annunciator, <a href="#">ALC OFF</a> , appears in the same position when the ALC circuit is disabled (see <a href="#">ALC OFF</a> , above).
UNLOCK	Any of the phase locked loops cannot maintain phase lock. To determine which loop is unlocked, examine the error messages (see <a href="#">“Reading Error Messages” on page 74</a> ).
WATRQ	The current modulation mode is waiting on the Arb trigger.
WINIT	The signal generator is waiting for you to initiate a single sweep.

## Rear Panel Overview – N5161A<sup>1</sup>/62A<sup>1</sup>/81A/82A MXG

Digital Modulation Connectors (Vector Models Only) on page 18

1. AC Power Receptacle

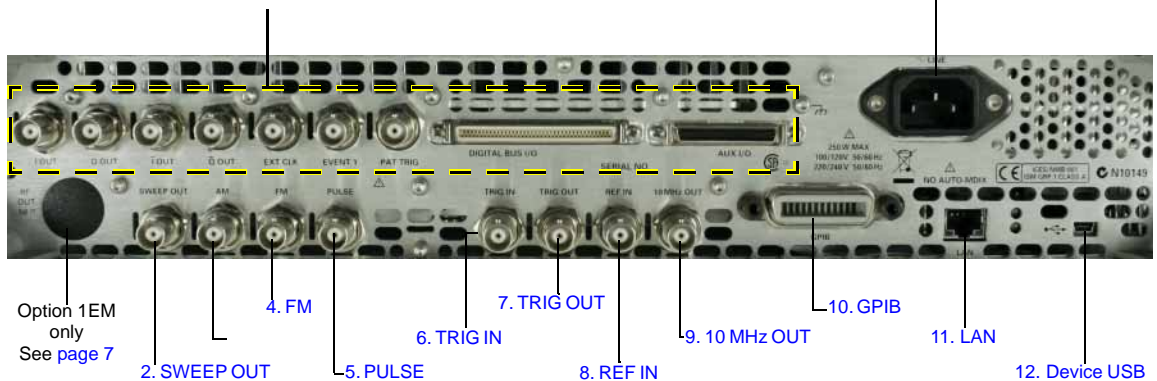

### 1. AC Power Receptacle

The AC power cord receptacle accepts a three-pronged AC power cord that is supplied with the signal generator. For details on line setting requirements and the power cord, see the *Installation Guide*.

---

**CAUTION** To avoid the loss of data, GPIB settings, or current user instrument states that have not been permanently saved to non-volatile memory, the MXG should always be powered down either via the MXG's front panel power button or the appropriate SCPI command. MXG's installed in rack systems and powered down with the system rack power switch rather than the MXG's front panel switch display a Error -310 due to the MXG not being powered down correctly.

---

### 2. SWEEP OUT

**Connector** female BNC      Impedance <1  $\Omega$   
Can drive 2 k $\Omega$ .

**Signal** Voltage range: 0 to +10 V, regardless of sweep width  
In swept mode: beginning of sweep = 0 V; end of sweep = +10 V  
In CW mode: no output

This is a multiple use connector. For signal routing selections, see pages 50 and 127.

<sup>1</sup>The N5161A and N5162A are only available with Option 1EM.

### 3. AM

<b>Connector</b>	female BNC	Impedance nominally 50 $\Omega$
<b>Signal</b>	An externally supplied $\pm 1 V_p$ signal that produces the indicated depth.	
<b>Damage Levels</b>	5 $V_{rms}$ and 10 $V_p$	

### 4. FM

<b>Connector</b>	female BNC	Impedance nominally 50 $\Omega$
<b>Signal</b>	An externally supplied $\pm 1 V_p$ signal that produces the indicated deviation	
<b>Damage Levels</b>	5 $V_{rms}$ and 10 $V_p$	

### 5. PULSE

<b>Connector</b>	female BNC	Impedance nominally 50 $\Omega$
<b>Signal</b>	Externally supplied: +1 V = on; 0 V = off	
<b>Damage Levels</b>	5 $V_{rms}$ and 10 $V_p$	

### 6. TRIG IN

<b>Connector</b>	female BNC	Impedance high Z
<b>Signal</b>	An externally supplied TTL or CMOS signal for triggering operations, such as point to point in manual sweep mode or an LF sweep in external sweep mode. Triggering can occur on either the positive or negative edge.	
<b>Damage Levels</b>	$\leq -0.5$ and $\geq +5.5$ V	

### 7. TRIG OUT

<b>Connector</b>	female BNC	Impedance nominally 50 $\Omega$
<b>Signal</b>	A TTL signal that is high at the start of a dwell sequence, or when waiting for the point trigger in manual sweep mode. It is low when the dwell is over, or when the point trigger is received. The logic polarity can be reversed.  This is a multiple use connector. For signal routing selections, see pages <a href="#">50</a> and <a href="#">127</a> .	

## 8. REF IN

**Connector** female BNC Impedance nominally 50  $\Omega$

**Signal** An externally supplied –3.5 to +20 dBm signal from a timebase reference that is within  $\pm 1$  ppm.

In its factory default mode, the signal generator can detect a valid reference signal at this connector and automatically switch from internal to external reference operation. See “[Presetting the Signal Generator](#)” on page 42. With Option 1ER (flexible reference input), you must explicitly tell the signal generator the external reference frequency you wish to use; enter the information through the front panel or over the remote interface.

## 9. 10 MHz OUT

**Connector** female BNC Impedance nominally 50  $\Omega$

**Signal** A nominal signal level greater than 4 dBm.

## 10. GPIB

This connector enables communication with compatible devices such as external controllers, and is one of three connectors available to remotely control the signal generator (see also [11. LAN](#) and [12. Device USB](#)).

## 11. LAN

The signal generator supports local area network (LAN) based communication through this connector, which enables a LAN-connected computer to remotely program the signal generator. The LAN interface supports auto-MDIX. The signal generator is limited to 100 meters on a single cable (100Base-T). For more information on the LAN, refer to the *Programming Guide*.

## 12. Device USB

**Connector** Mini-B

**USB Protocol** Version 2.0

Use this universal serial bus (USB) connector to connect a PC to remotely control the signal generator.

## Digital Modulation Connectors (Vector Models Only)

### I OUT, Q OUT, $\bar{I}$ OUT, $\bar{Q}$ OUT

---

**NOTE**  $\bar{I}$  OUT and  $\bar{Q}$  OUT, require Option 1EL.

---

**Connector** Type: female BNC Impedance: 50  $\Omega$   
DC-coupled

#### Signal

I OUT The analog, in-phase component of I/Q modulation from the internal baseband generator.

Q OUT The analog, quadrature-phase component of I/Q modulation from the internal baseband generator.

$\bar{I}$  OUT Used in conjunction with the I OUT connector to provide a balanced<sup>a</sup> baseband stimulus.

$\bar{Q}$  OUT Used in conjunction with the Q OUT connector to provide a balanced<sup>a</sup> baseband stimulus.

**Damage Levels** > 1 Vrms **DC Origin Offset** typically <10 mV

#### Output Signal Levels into a 50 $\Omega$ Load

- 0.5 V<sub>pk</sub>, typical, corresponds to one unit length of the I/Q vector
- 0.69 V<sub>pk</sub> (2.84 dB), typical, maximum crest factor for peaks for  $\pi/4$  DQPSK, alpha = 0.5
- 0.71 V<sub>pk</sub> (3.08 dB), typical, maximum crest factor for peaks for  $\pi/4$  DQPSK, alpha = 0.35
- Typically 1 V<sub>p-p</sub> maximum

<sup>a</sup>Balanced signals are signals present in two separate conductors that are symmetrical relative to ground, and are opposite in polarity (180 degrees out of phase).

### EXT CLK

**Connector** female BNC Impedance nominally 50  $\Omega$

**Signal** An externally supplied TTL or CMOS bit clock signal where the rising edge aligns with the beginning data bit.

The falling edge is used to clock external signals.

This signal is used with digital modulation applications.

**Damage Levels** < -4 and > +8 V **Maximum Clock Rate** 50 MHz



## EVENT 1

**Connector** female BNC Impedance: nominally 50  $\Omega$

**Signal** A pulse that can be used to trigger the start of a data pattern, frame, or timeslot.  
Adjustable to  $\pm$  one timeslot; resolution = one bit

**Markers**

Each Arb-based waveform point has a marker on/off condition associated with it.

Marker 1 level = +3.3 V CMOS high (positive polarity selected); -3.3 V CMOS low (negative polarity selected).

Output on this connector occurs whenever Marker 1 is on in an Arb-based waveform (see “Using Waveform Markers” on page 157).

**Damage Levels** < -4 and > +8 V

## PAT TRIG

**Connector** female BNC Impedance: nominally 50  $\Omega$

**Signal** A TTL/CMOS low to TTL/CMOS high, or TTL/CMOS high to TTL/CMOS low edge trigger. The input to this connector triggers the internal digital modulation pattern generator to start a single pattern output or to stop and re-synchronize a pattern that is being continuously output. To synchronize the trigger with the data bit clock, the trigger edge is latched, then sampled during the falling edge of the internal data bit clock. This is the external trigger for all ARB waveform generator triggers.

**Minimum Trigger Input Pulse Width** (high or low) = 100 ns

**Minimum Trigger Delay** (trigger edge to first bit of frame) = 1.5 to 2.5 bit clock periods

**Damage Levels** < -4 and > +8 V

## DIGITAL BUS I/O

This is a proprietary bus used by Agilent Technologies signal creation software. This connector is not operational for general purpose use. Signals are present only when a signal creation software option is installed (for details, refer to <http://www.agilent.com/find/signalcreation>).

---

**NOTE** The MXG's Digital BUS I/O connector can be used for enabling operation with the Agilent Technologies N5106A PXB MIMO Receiver Tester.

---

## AUX I/O



The AUX I/O connector is a shielded .050 series board mount connector.

Pin 1 = Event 1  
Pin 2 = Event 2  
Pin 3 = Event 3  
Pin 4 = Event 4  
Pin 5 = Sample Rate Clock Out  
Pin 6 = Patt Trig 2

Pins 7–25 = Reserved\*

Pins 26–50 = Ground

\*Future Capability

### Event 1, 2, 3, and 4 (pins 1 – 4)

A pulse that can be used to trigger the start of a data pattern, frame, or timeslot. Adjustable to  $\pm$  one timeslot; resolution = one bit

### Markers

Each Arb-based waveform point has a marker on/off condition associated with it. Marker level = +3.3 V CMOS high (positive polarity selected); -3.3 V CMOS low (negative polarity selected).

### Sample Rate Clock Out (pin 5)

This output is used with an internal baseband generator. This pin relays a CMOS bit clock signal for synchronizing serial data. Damage levels: < -0.5 and > +5.5 V.

### Patt Trig 2 (pin 6)

A TTL/CMOS low to TTL/CMOS high, or TTL/CMOS high to TTL/CMOS low edge trigger. The input to this connector triggers the internal digital modulation pattern generator to start a single pattern output or to stop and re-synchronize a pattern that is being continuously output.

To synchronize the trigger with the data bit clock, the trigger edge is latched, then sampled during the falling edge of the internal data bit clock.

This is an external trigger for all ARB waveform generator triggers. Minimum pulse width = 100 ns. Damage levels: < -0.5 and > +5.5 V.

## Rear Panel Overview – N5183A MXG

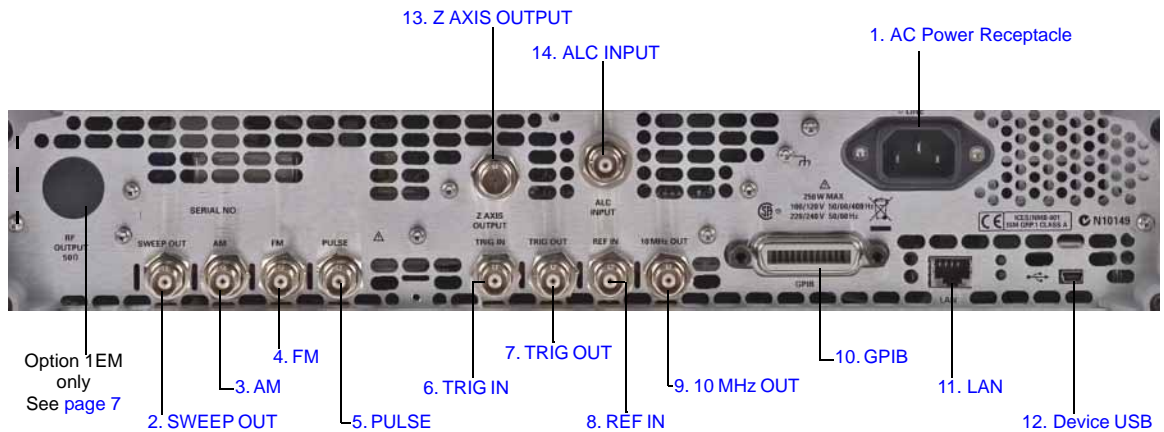

### 1. AC Power Receptacle

The AC power cord receptacle accepts a three-pronged AC power cord that is supplied with the signal generator. For details on line setting requirements and the power cord, refer to the *Installation Guide*.

---

**CAUTION** To avoid the loss of data, GPIB settings, or current user instrument states that have not been permanently saved to non-volatile memory, the MXG should always be powered down either via the MXG's front panel power button or the appropriate SCPI command. MXG's installed in rack systems and powered down with the system rack power switch rather than the MXG's front panel switch display a Error -310 due to the MXG not being powered down correctly.

---

### 2. SWEEP OUT

**Connector** female BNC      Impedance <1  $\Omega$   
Can drive 2 k $\Omega$ .

**Signal** Voltage range: 0 to +10 V, regardless of sweep width  
In swept mode: beginning of sweep = 0 V; end of sweep = +10 V  
In CW mode: no output

This is a multiple use connector. For signal routing selections, see pages 50 and 127.

### 3. AM

<b>Connector</b>	female BNC	Impedance nominally 50 $\Omega$
<b>Signal</b>	An externally supplied $\pm 1 V_p$ signal that produces the indicated depth.	
<b>Damage Levels</b>	5 $V_{rms}$ and 10 $V_p$	

### 4. FM

<b>Connector</b>	female BNC	Impedance nominally 50 $\Omega$
<b>Signal</b>	An externally supplied $\pm 1 V_p$ signal that produces the indicated deviation	
<b>Damage Levels</b>	5 $V_{rms}$ and 10 $V_p$	

### 5. PULSE

<b>Connector</b>	female BNC	Impedance nominally 50 $\Omega$
<b>Signal</b>	Externally supplied: +1 V = on; 0 V = off	
<b>Damage Levels</b>	5 $V_{rms}$ and 10 $V_p$	

### 6. TRIG IN

<b>Connector</b>	female BNC	Impedance high Z
<b>Signal</b>	An externally supplied TTL or CMOS signal for triggering operations, such as point to point in manual sweep mode or an LF sweep in external sweep mode. Triggering can occur on either the positive or negative edge.	
<b>Damage Levels</b>	$\leq -0.5$ and $\geq +5.5$ V	

### 7. TRIG OUT

<b>Connector</b>	female BNC	Impedance nominally 50 $\Omega$
<b>Signal</b>	A TTL signal that is high at the start of a dwell sequence, or when waiting for the point trigger in manual sweep mode. It is low when the dwell is over, or when the point trigger is received. The logic polarity can be reversed.  This is a multiple use connector. For signal routing selections, see pages <a href="#">50</a> and <a href="#">127</a> .	

### 8. REF IN

<b>Connector</b>	female BNC	Impedance nominally 50 $\Omega$
<b>Signal</b>	An externally supplied $-3.5$ to $+20$ dBm signal from a timebase reference that is within $\pm 1$ ppm.	

In its factory default mode, the signal generator can detect a valid reference signal at this connector and automatically switch from internal to external reference operation. See “[Presetting the Signal Generator](#)” on [page 42](#). With Option 1ER (flexible reference input), you must explicitly tell the signal generator the external reference frequency you wish to use; enter the information through the front panel or over the remote interface.

## 9. 10 MHz OUT

**Connector** female BNC Impedance nominally 50  $\Omega$

**Signal** A nominal signal level greater than 4 dBm.

## 10. GPIB

This connector enables communication with compatible devices such as external controllers, and is one of three connectors available to remotely control the signal generator (see also [11. LAN](#) and [12. Device USB](#)).

## 11. LAN

The signal generator supports local area network (LAN) based communication through this connector, which enables a LAN-connected computer to remotely program the signal generator. The LAN interface supports LXI; it does not support auto-MDIX. The signal generator is limited to 100 meters on a single cable (100Base-T). For more information on the LAN, refer to the *Programming Guide*.

## 12. Device USB

**Connector** Mini-B

**USB Protocol** Version 2.0

Use this universal serial bus (USB) connector to connect a PC to remotely control the signal generator.

## 13. Z AXIS OUTPUT

This female BNC connector supplies a +5 V (nominal) level during retrace and band-switch intervals of a step or list sweep. During step or list sweep, this female BNC connector supplies a -5 V (nominal) level when the RF frequency is at a marker frequency and intensity marker mode is on. This signal is derived from an operational amplifier output so the load impedance should be greater than or equal to 5 kohms.

## 14. ALC INPUT

This input connector is used for negative external detector leveling.

**Connector**            female BNC    Impedance nominally 100 k $\Omega$

**Signal**                -0.2 mV to -0.5 V

**Damage Levels**    -12 to 1 V

## 2 Setting Preferences & Enabling Options

**NOTE** For the N5161A/62A MXG ATE the softkey menus and features mentioned in this guide are only available through the Web-Enabled MXG or SCPI commands. For information on the Web-Enabled MXG, refer to the *Installation Guide*, the *Programming Guide*, and to the *SCPI Command Reference*.

The Utility menu provides access to both user and remote operation preferences, and to the menus in which you can enable instrument options.

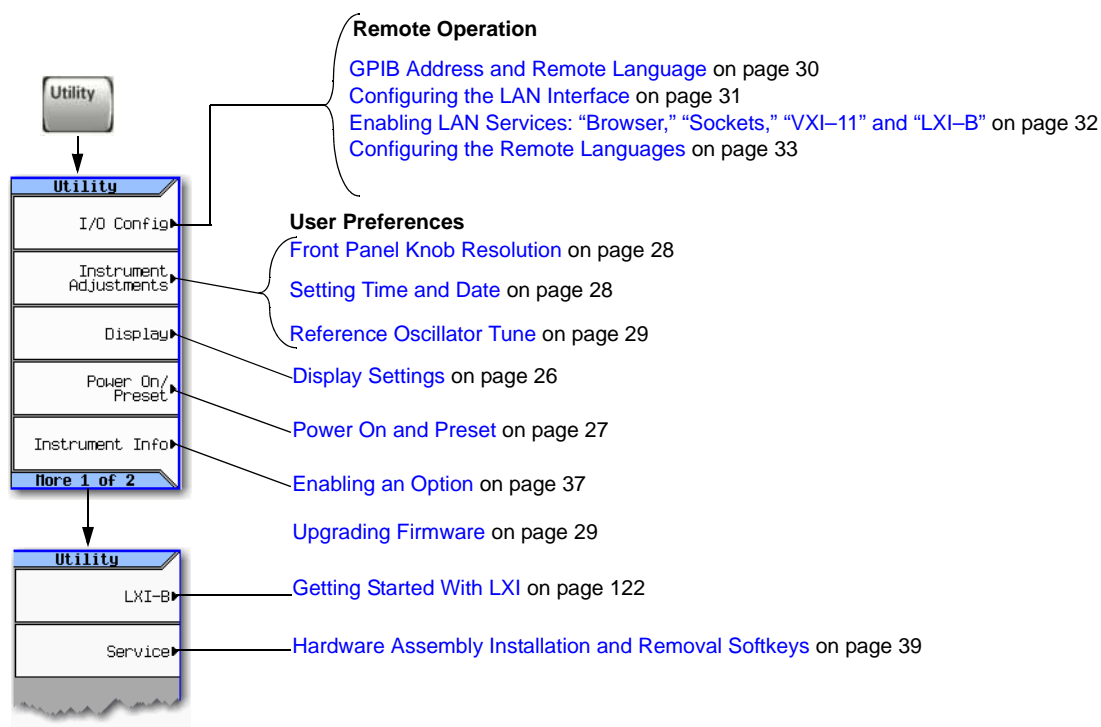

## User Preferences

From the Utility menu, you can set the following user preferences:

- [Display Settings](#), below
- [Power On and Preset](#) on page 27
- [Front Panel Knob Resolution](#) on page 28

## Display Settings

See also, [Using the Secure Display \(Option 006 Only\)](#) on page

Utility > Display

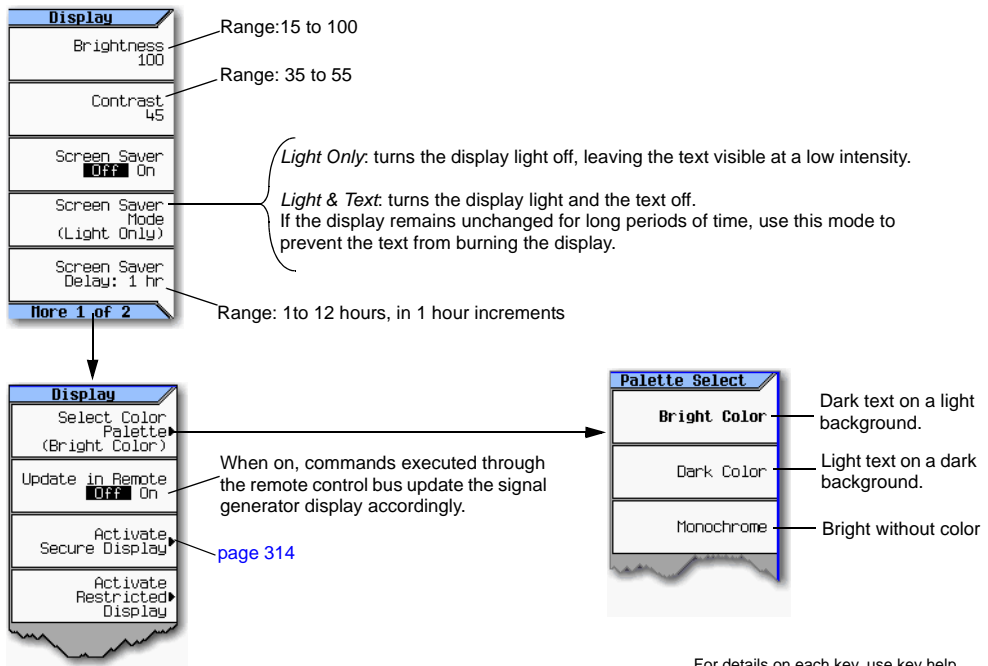

For details on each key, use key help as described on [page 42](#).

**NOTE** With both brightness and contrast set to minimum, the display may be too dark to see the softkeys. If this happens, use the figure above to locate the brightness and contrast softkeys and adjust their values so that you can see the display.



## Power On and Preset

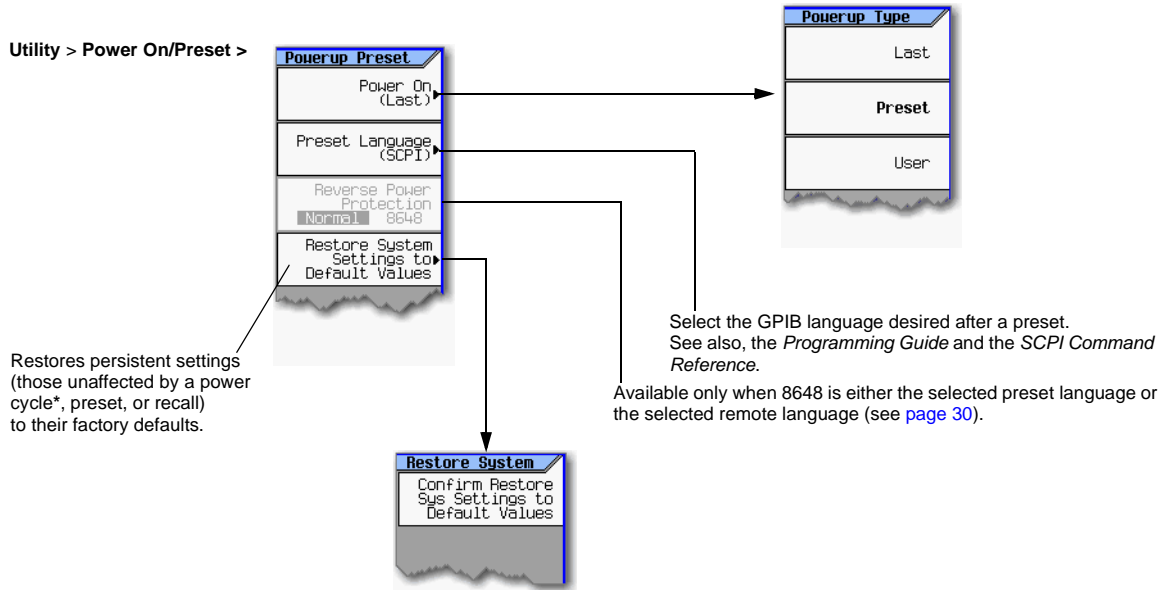

### \*Caution

To avoid the loss of data, GPIB settings, or current user instrument states that have not been permanently saved to non-volatile memory, the MXG should always be powered down either via the MXG's front panel power button or the appropriate SCPI command. MXG's installed in rack systems and powered down with the system rack power switch rather than the MXG's front panel switch display a Error -310 due to the MXG not being powered down correctly.

### Note

To define a user preset, set the instrument up as desired and press **User Preset > Save User Preset**.

## Front Panel Knob Resolution

**Incr Set** — Makes the increment value of the current function the active entry.

Utility >  
Instrument Adjustments >

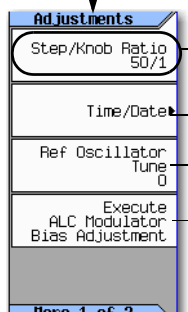

The increment value and the step/knob ratio determine how much each turn of the knob changes the active function value.

For example, if the increment value of the active function is 10 dB and the step/knob ratio is 50 to 1, each turn of the knob changes the active function by 0.2 dB (1/50th of 10 dB).

To change the amount for each turn of the knob, modify the increment value, the step/knob ratio, or both.

Executes the ALC Modulator Bias Adjustment. When using the ALC in open loop mode, this compensates for open loop power drift due to temperature and humidity.

SCPI Commands:  
:CALibration:ALC:MODulator:BIAS

For details on each key, use key help as described on page 42.

## Setting Time and Date

**CAUTION** Changing the time or date can adversely affect the signal generator's ability to use time-based licenses, even if a time-based license is not installed.

The signal generator's firmware tracks the time and date, and uses the *latest* time and date as its time/date reference point.

Utility >  
Instrument Adjustments >

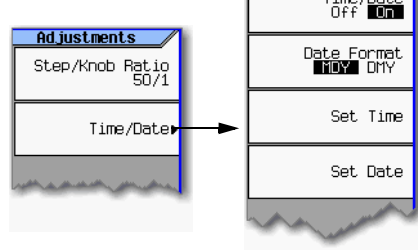

### Setting the Time or Date Forward

If you set the time or date forward, be aware that you are using up any installed time-based licenses, and that you are *resetting the signal generator's time/date reference point*. When you set a new time or date that is later than the signal generator's current reference point, that date becomes the new reference point. If you then set the date back, you run the risk described in the next section.

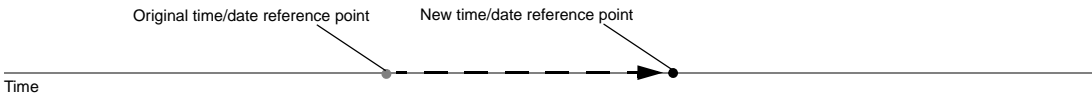

### Setting the Time or Date Backward

When you set the time back, the signal generator notes that the time has moved back from the reference point. If you set the time back more a few hours, you disable the signal generator's ability to use time-based licenses, even if there is no license installed at the time that you set the time

back. In this case, you can re-enable the signal generator's ability to use time-based licenses by moving the clock forward to the original time or simply waiting that length of time.

## Reference Oscillator Tune

Utility > Instrument Adjustments >

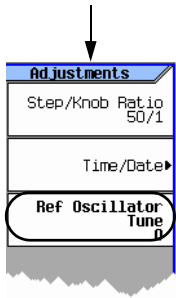

Tunes the internal VCTXCO oscillator frequency.

The user value offsets the factory tuned value (the value is added to the factory calibrated DAC value). The tune value of 0 sets the factory calibrated value.

The range; -8192 to 8192, can be set by using the front panel keypad, knob or remote command.

For details on each key, use key help as described on [page 42](#).

See also the *SCPI Command Reference*.

## Upgrading Firmware

For information on new firmware releases, go to <http://www.agilent.com/find/upgradeassistant>.

## Remote Operation Preferences

For details on operating the signal generator remotely, refer to the *Programming Guide*.

### GPIB Address and Remote Language

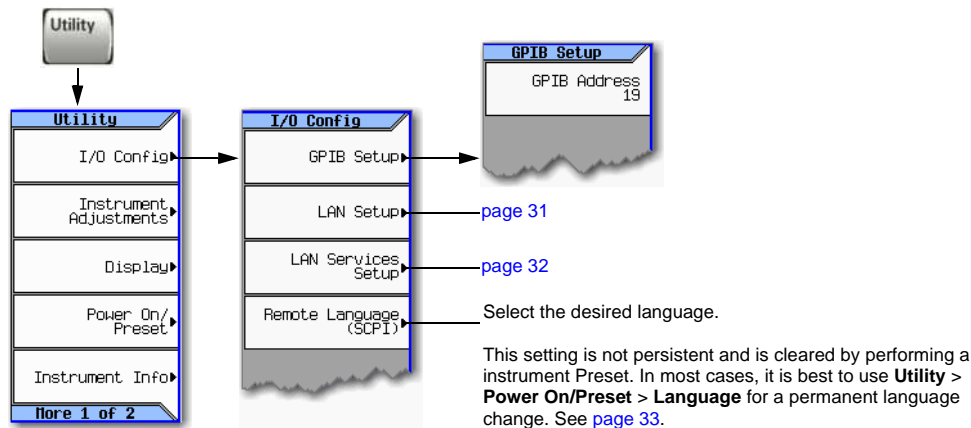

#### NOTES

USB is also available. It is not shown in the menu because it requires no configuration.

For details on using the instrument remotely, see the *Programming Guide*.

For details on each key, use key help as described on [page 42](#).

## Configuring the LAN Interface

Utility > I/O Config

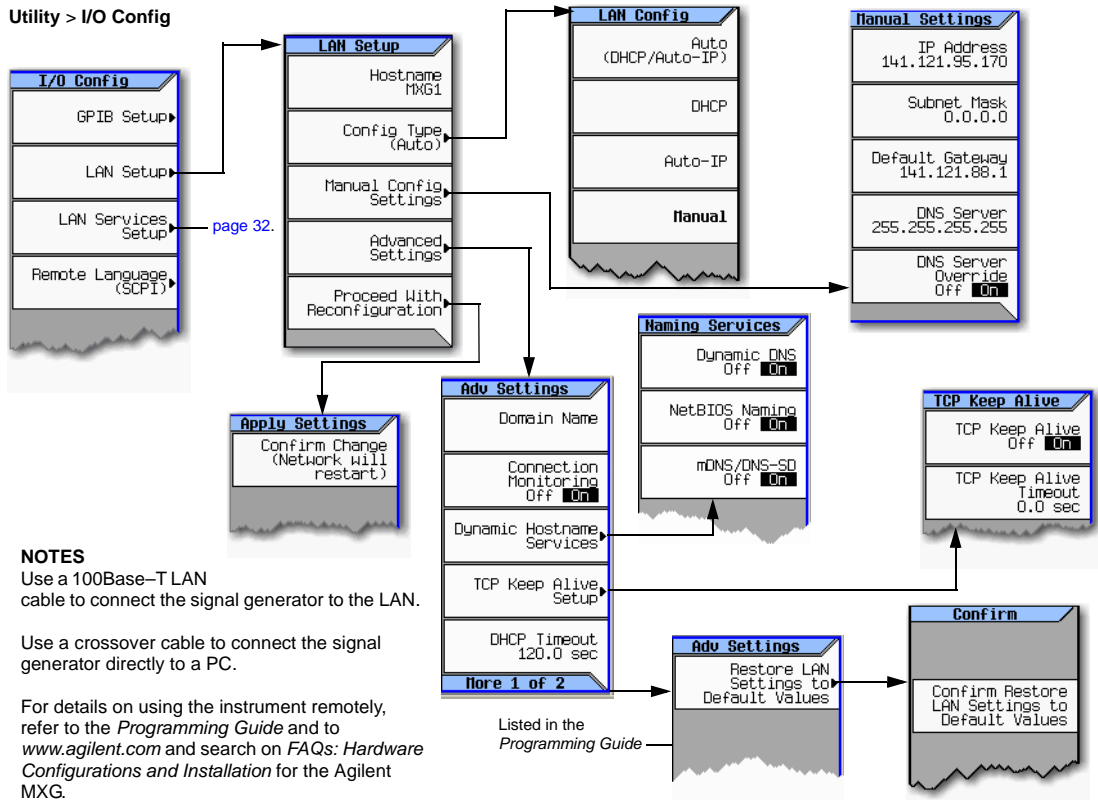

### NOTES

Use a 100Base-T LAN cable to connect the signal generator to the LAN.

Use a crossover cable to connect the signal generator directly to a PC.

For details on using the instrument remotely, refer to the *Programming Guide* and to [www.agilent.com](http://www.agilent.com) and search on FAQs: *Hardware Configurations and Installation* for the Agilent MXG.

For details on each key, use key help as described on page 42.

## Enabling LAN Services: "Browser," "Sockets," "VXI-11" and "LXI-B"<sup>1</sup>

Utility > I/O Config

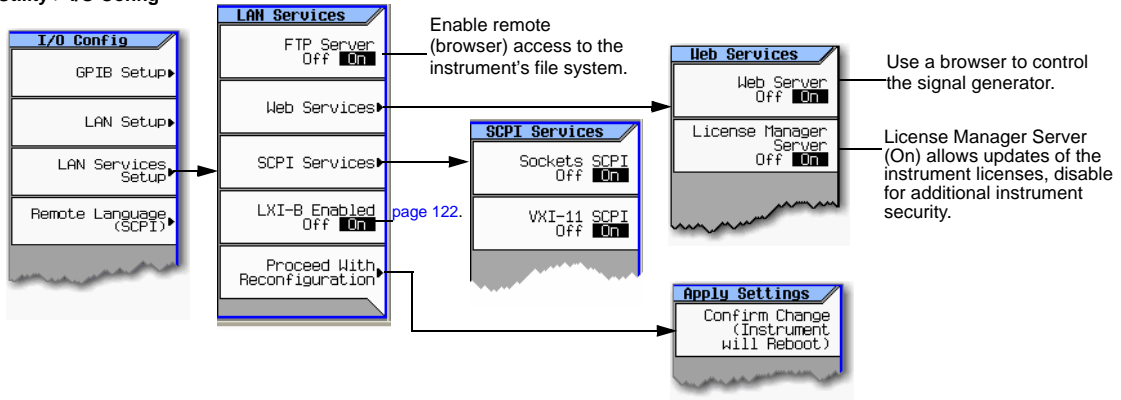

For details on each key, use key help as described on [page 42](#).

For more information refer to the *Programming Guide*.

<sup>1</sup>Option ALB LXI-B is only available on instruments with serial prefixes  $\geq$ US/MY/SG4818.

## Configuring the Remote Languages

Figure 2-1 N5161A/62A/81A/82A

Utility > I/O Config

Select the desired Remote language.

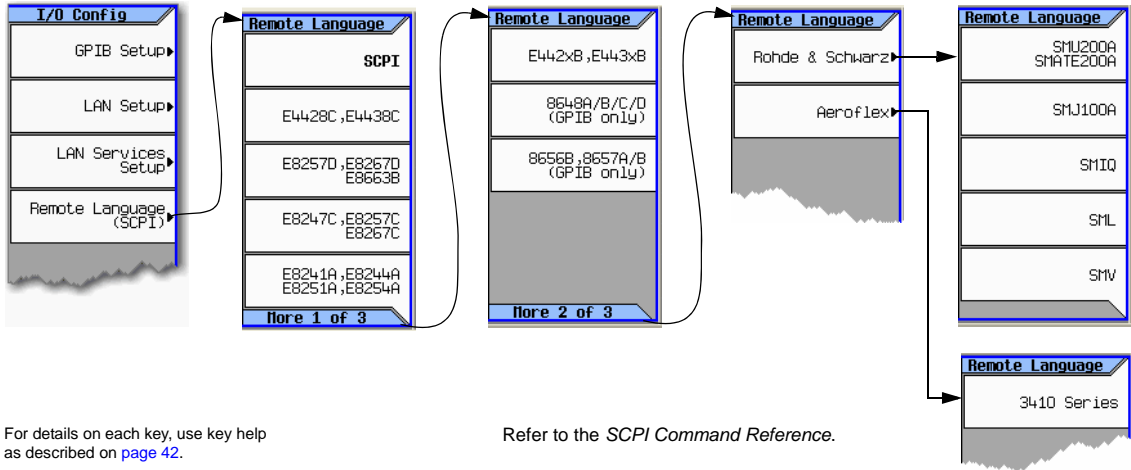

For details on each key, use key help as described on [page 42](#).

Refer to the *SCPI Command Reference*.

Figure 2-2 N5183A

Utility > I/O Config >

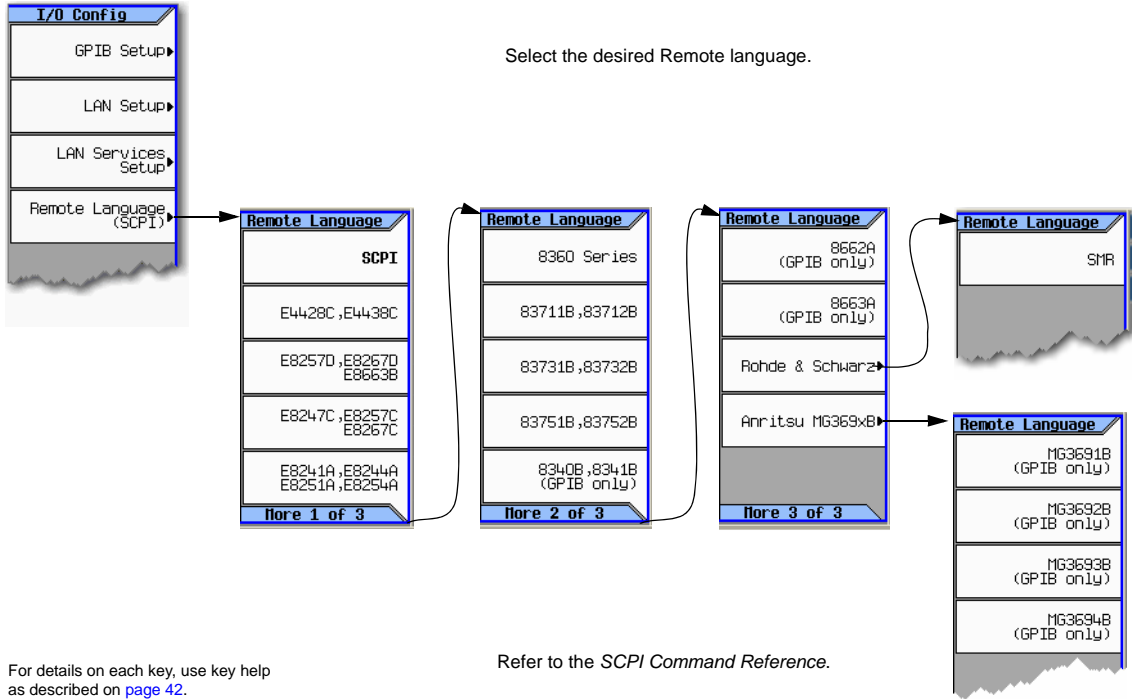



## Configuring the Preset Languages

Figure 2-3 N5161A/62A/81A/82A

Utility> Power On/Preset

Select the desired Remote language.

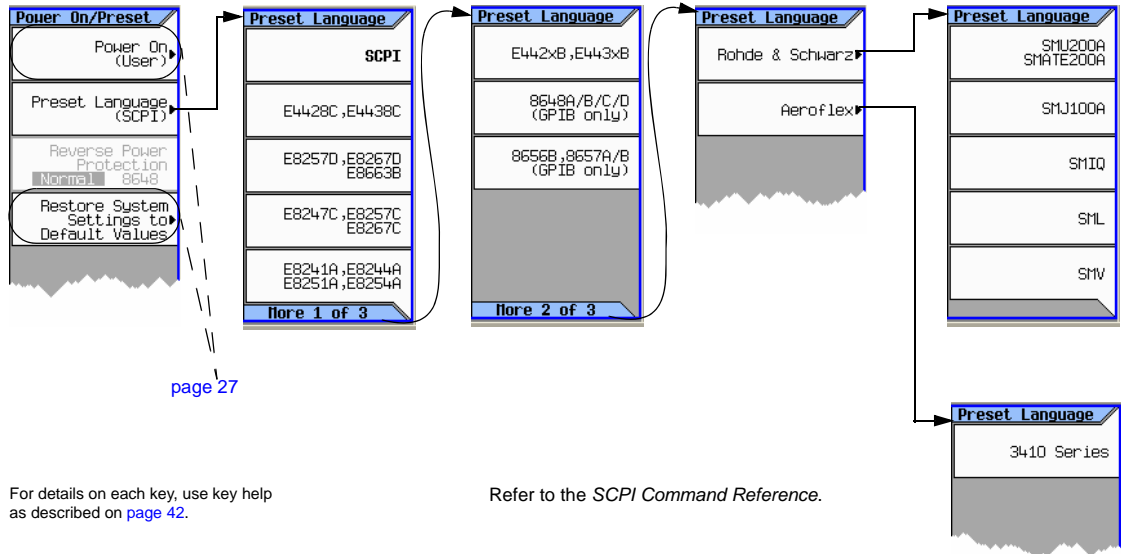

For details on each key, use key help as described on [page 42](#).

Refer to the *SCPI Command Reference*.

Figure 2-4 N5183A

Utility > Power On/Presets

Select the desired Remote language.

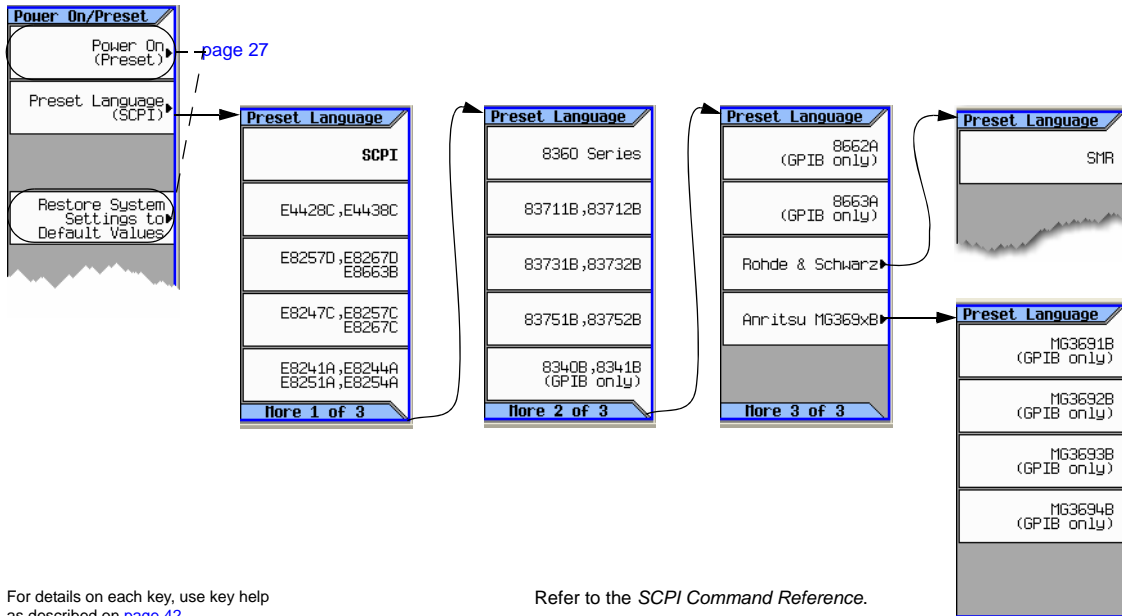

For details on each key, use key help as described on page 42.

Refer to the *SCPI Command Reference*.

## Enabling an Option

There are two ways to enable an option:

- Use the License Manager software utility:
  1. Run the utility and follow the prompts.
  2. Download the utility from [www.agilent.com/find/LicenseManager](http://www.agilent.com/find/LicenseManager) and select license (.lic) files from an external USB Flash Drive (UFD).
- Use SCPI commands, as described in the *Programming Guide*.

## Viewing Options and Licenses

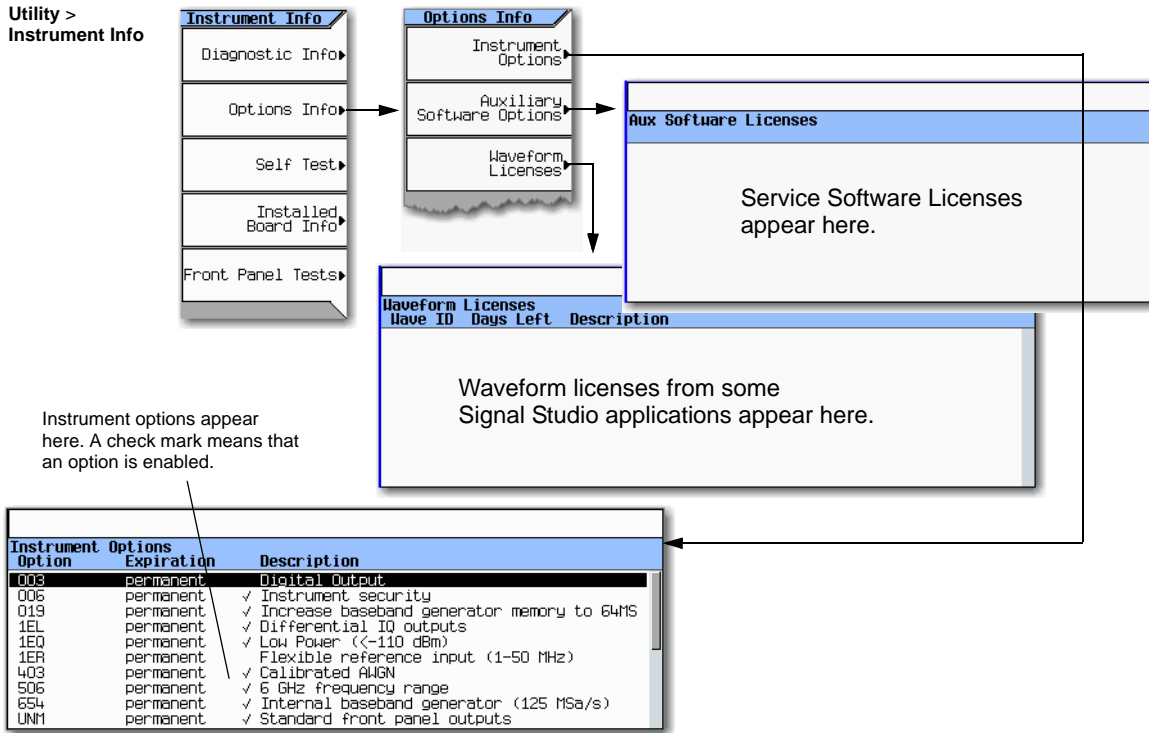

For details on each key, use key help as described on [page 42](#).

## Hardware Assembly Installation and Removal Softkeys

Utility > More 2 of 2 > Service

For details on each key, use key help as described on [page 42](#).

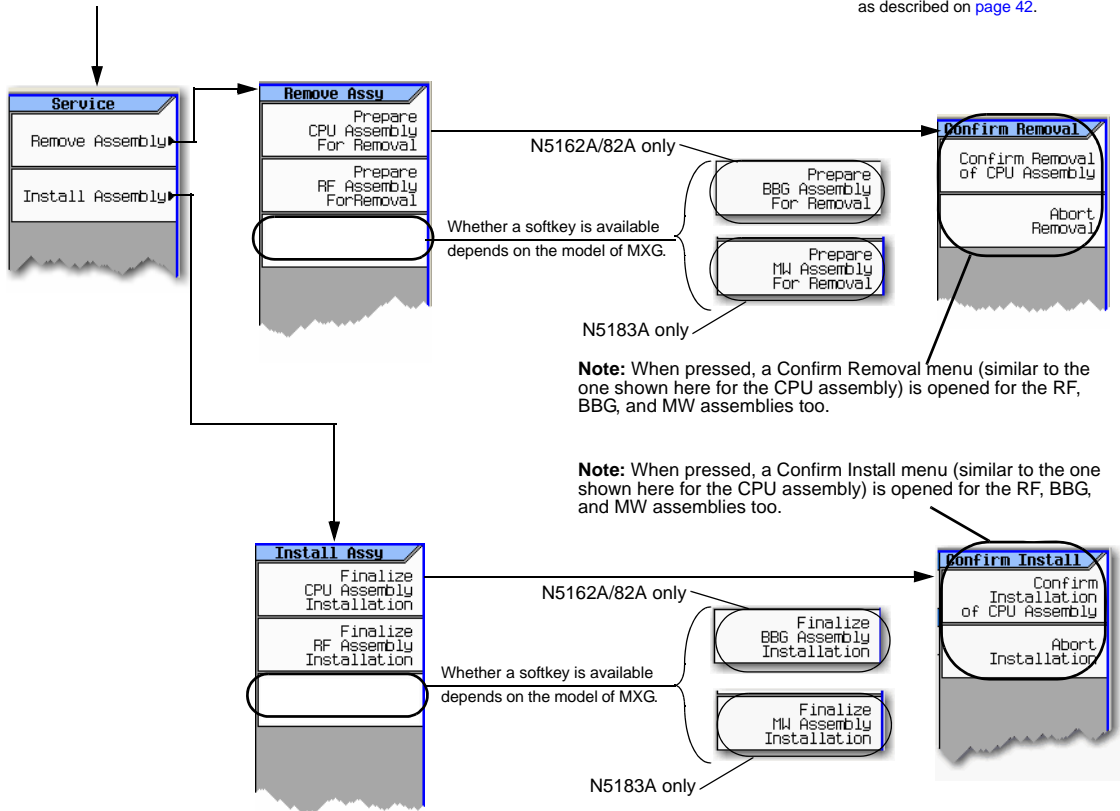

Note:

Each **Remove Assembly** softkey (CPU/RF/BBG/MW) when enabled will display a message in the lower left quadrant of display indicating assembly prepared for removal or removal has been aborted.

Each **Install Assembly** softkey, when enabled will display a message in the lower left quadrant of display indicating assembly prepared for installation or installation has been aborted.

Refer also, to the *Service Guide*.



---

## 3 Basic Operation

---

**NOTE** For the N5161A/62A the softkey menus and features mentioned in this guide are only available through the Web-Enabled MXG or SCPI commands. For information on the Web-Enabled MXG, refer to the *Installation Guide*, the *Programming Guide*, and the *SCPI Command Reference*.

---

This chapter introduces fundamental front panel operation. For information on remote operation, refer to the *Programming Guide*.

- [Presetting the Signal Generator](#) on page 42
- [Viewing Key Descriptions](#) on page 42
- [Entering and Editing Numbers and Text](#) on page 43
- [Setting Frequency and Power \(Amplitude\)](#) on page 45
- [Setting ALC Bandwidth Control](#) on page 47
- [Configuring a Swept Output](#) on page 48
- [Modulating the Carrier Signal](#) on page 60
- [Working with Files](#) on page 62
- [Reading Error Messages](#) on page 74

## Presetting the Signal Generator



To return the signal generator to a known state, press either **Preset** or **User Preset**.

*Preset* is the factory preset; *User Preset* is a custom preset\*\* (see also, [page 27](#)).

To reset persistent settings (those unaffected by preset, user preset, or power cycle\*), press: **Utility > Power On/Preset > Restore System Defaults**.

### \*Caution

To avoid the loss of data, GPIB settings, or current user instrument states that have not been permanently saved to non-volatile memory, the MXG should always be powered down either via the MXG's front panel power button or the appropriate SCPI command. MXG's installed in rack systems and powered down with the system rack power switch rather than the MXG's front panel switch display a Error -310 due to the MXG not being powered down correctly.

\*\*You can create more than one user preset by giving each saved state file a different name (see [Figure 3-12 on page 72](#)).

## Viewing Key Descriptions



The Help hardkey enables you to display a description of any hardkey or softkey.

To display help text:

1. Press **Help**.
2. Press the desired key.  
The help displays and the key's normal function does not execute.



## Entering and Editing Numbers and Text

### Entering Numbers and Moving the Cursor

Use the number keys and decimal point to enter numeric data.

Up/down arrow keys increase/decrease a selected (highlighted) numeric value, and move the cursor vertically.

Page up/down keys move tables of data up and down within the display area.

Left/right arrow keys move the cursor horizontally.

Use the **Select** hardkey to choose part of an entry, as when entering alpha characters. In some menus, the **Select** key also acts as a terminator, and is equivalent to the **Enter** softkey.

To specify a negative value, enter the negative sign either before or after the numeric value (this key is a toggle).

Backspace moves the cursor to the left, deleting characters as it goes.



**Note:** Rotating the knob increases or decreases a numeric value, changes a highlighted digit or character, or steps through lists or items in a row.

See also, [Front Panel Knob Resolution](#) on page 19

For details on each key, see [page 42](#).

### Entering Alpha Characters

**Note:** File names are limited to 25 characters.

Data entry softkeys appear in various menus. If their meaning is not clear in context, use the help key (described on [page 42](#)) to display an explanation. Use the softkey next to the alpha table for help on the table.

Selecting data that accepts alpha characters, displays one of the menus shown at right.

Use the arrow keys or knob to highlight the desired letter, then press the **Select** hardkey (or the softkey next to the alpha table). To correct errors, use **Bk Sp** or **Clear Text**.

To terminate the entry, press the **Enter** softkey.

A subset of this menu appears for hexadecimal characters. The character menu displays only the letters A through F (use the numeric keypad for other values).

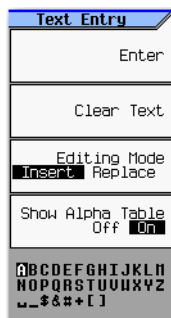

to move the cursor within the active value rather than within the alpha table, turn the alpha table off.

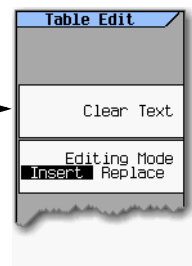
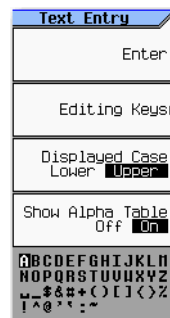

Add/edit comments for saved instrument state files (see [page 69](#)).

### Example: Using a Table Editor

Table editors simplify configuration tasks. The following procedure describes basic table editor functionality using the List Mode Values table editor.

1. Preset the signal generator: Press **Preset**.
2. Open the table editor: Press **Sweep > More > Configure List Sweep**.

The signal generator displays the editor shown in the following figure.

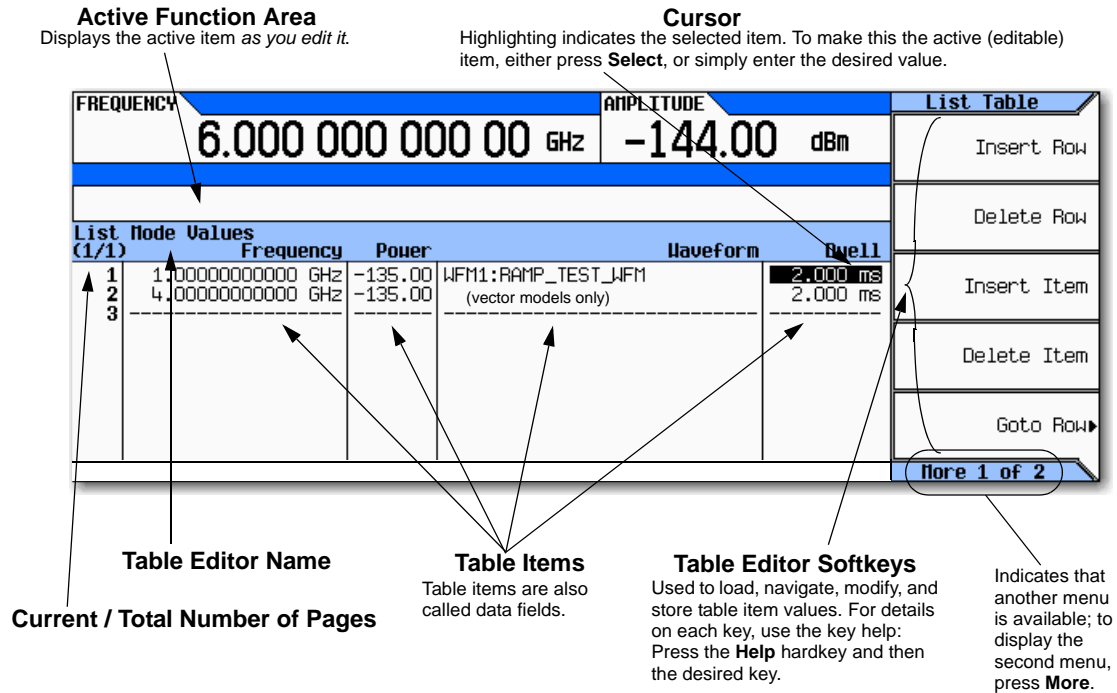

3. Highlight the desired item: use the arrow keys or the knob to move the cursor.
4. (Optional) Display the selected item in the active function area: Press **Select**.
5. Modify the value:
  - If the value is displayed in the active function area, use the knob, arrow keys, or numeric keypad to modify the value.
  - If the value is not displayed in the active function area, use the numeric keypad to enter the desired value (which then appears in the active function area).
6. Terminate the entry:
  - If available, press the desired units.
  - If units are not displayed, press either **Enter** (if available) or **Select**.

The modified item is displayed in the table.

## Setting Frequency and Power (Amplitude)

Figure 3-1 Frequency and Amplitude Softkeys

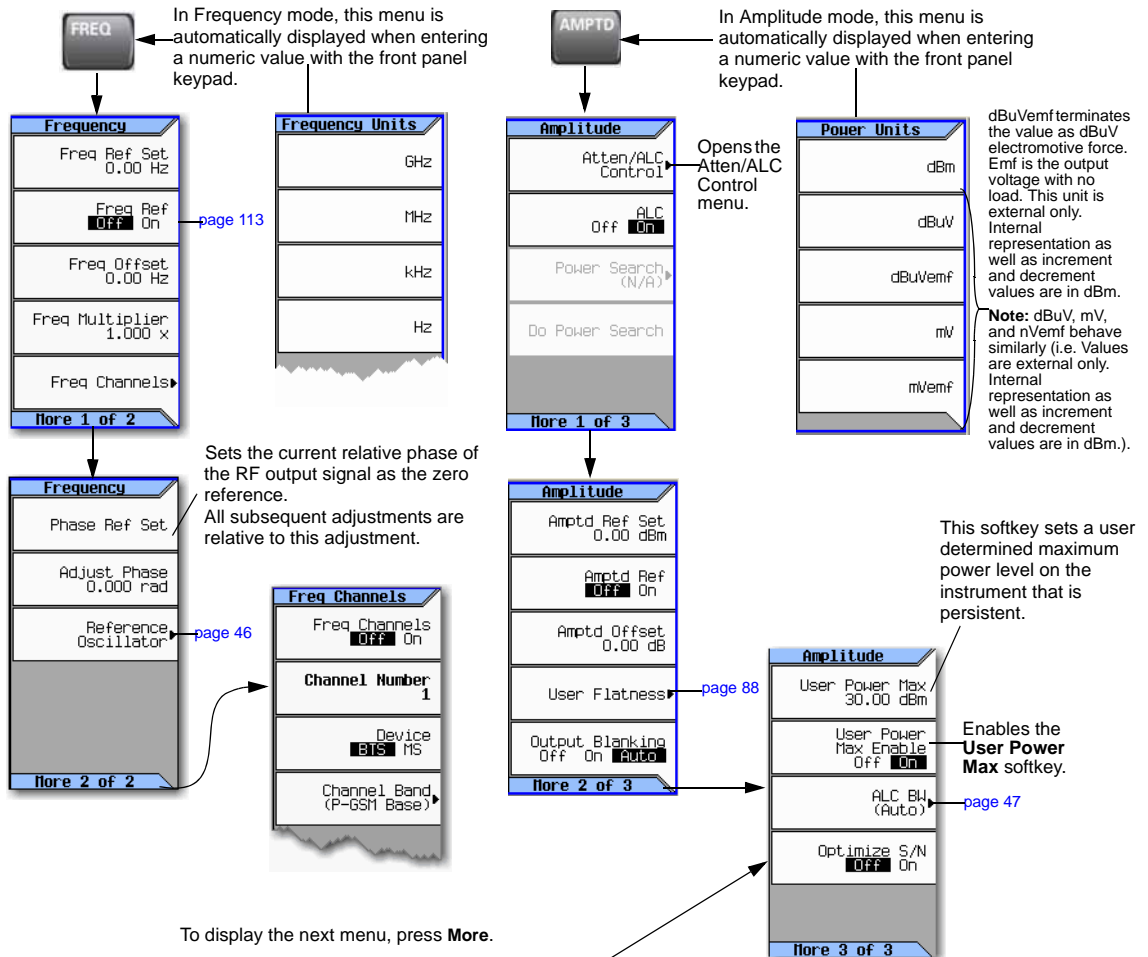

To display the next menu, press More.

Enables the optimize signal-to-noise ratio state (**Optimize S/N**) On or Off.

The optimize signal-to-noise softkey changes the attenuator and alc setting to provide optimal signal-to-noise performance; it does *not* change the RF output power.

**Caution:** When the optimize signal-to-noise ratio state is enabled, some increased levels of harmonic distortion can occur. This increased harmonic distortion could degrade ACPR and EVM.

**Note:** This mode is mutually exclusive with attenuator hold (**Atten Hold**), and any modulation type. A settings conflict error will be generated if attenuator hold or any modulation is activated when optimize signal-to-noise is active (On).

For details on each key, use key help as described on page 42.

Refer to the *SCPI Command Reference*.

### Example: Configuring a 700 MHz, -20 dBm Continuous Wave Output

1. Preset the signal generator.

The signal generator displays its maximum specified frequency and minimum power level (the front panel display areas are shown on [page 11](#)).

2. Set the frequency to 700 MHz: Press **Freq > 700 > MHz**.

The signal generator displays 700 MHz in both the FREQUENCY area of the display and the active entry area.

3. Set the amplitude to -20 dBm: Press **Amptd > -20 > dBm**.

The display changes to -20 dBm in the AMPLITUDE area of the display, and the amplitude value becomes the active entry. Amplitude remains the active function until you press another function key.

4. Turn on the RF Output: Press **RF On/Off**.

The RF Output LED lights, and a 700 MHz, -20 dBm CW signal is available at the RF OUTPUT connector.

### Using an External Reference Oscillator

When using an external reference, you can select either narrow or wide bandwidth mode.

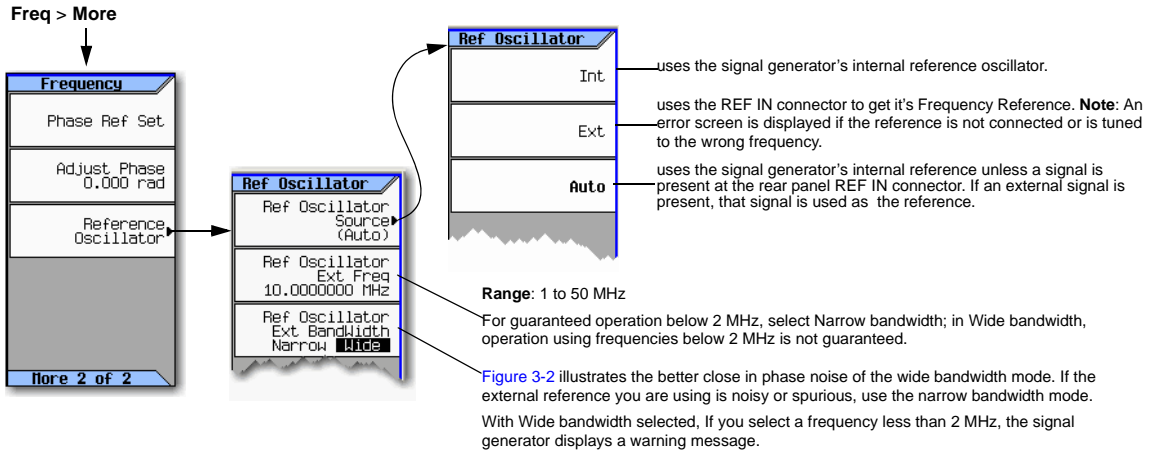

For details on each key, use key help as described on [page 42](#).

Figure 3-2 Using an External Reference Oscillator

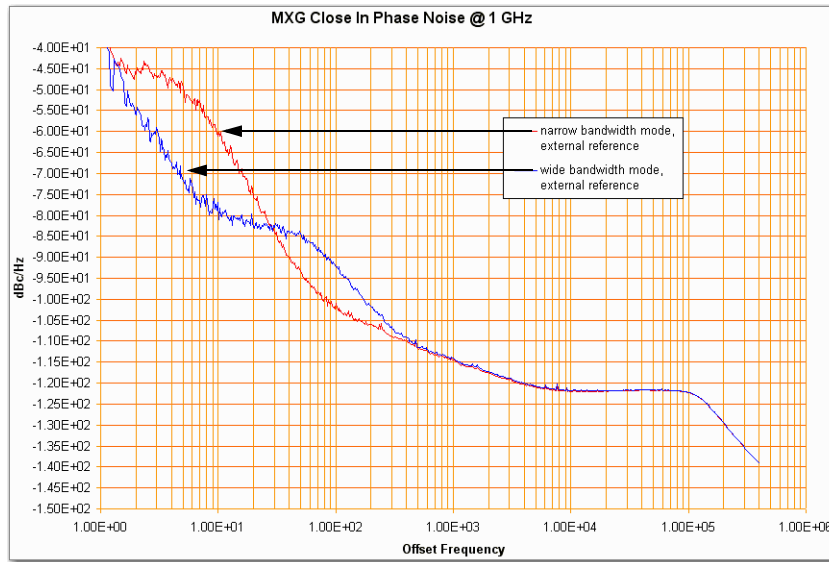

## Setting ALC Bandwidth Control

Figure 3-3 Amplitude Softkeys

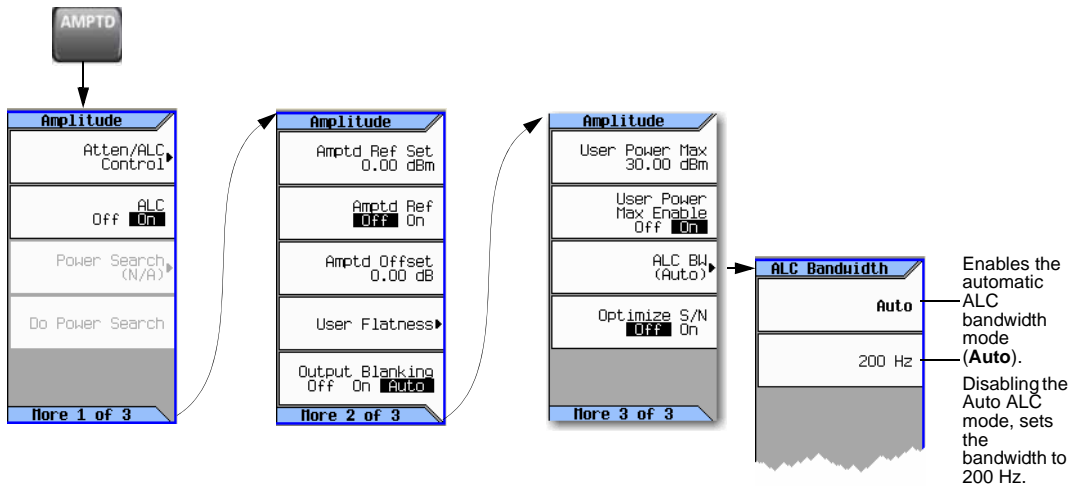

For details on each key, use key help as described on [page 42](#).

Refer to the *SCPI Command Reference*.

To display the next menu, press **More**.

## Configuring a Swept Output

The signal generator has two methods of sweeping through a set of frequency and amplitude points:

*Step sweep* ([page 50](#)) provides a linear or logarithmic progression from one selected frequency, amplitude, or both, to another, pausing at linearly or logarithmically spaced points (steps) along the sweep. The sweep can progress forward, backward, or manually.

*List sweep* ([page 56](#)) enables you to enter frequencies and amplitudes at unequal intervals, in nonlinear ascending, descending, or random order. List sweep also enables you to copy the current step sweep values, include an Arb waveform in a sweep (on a vector instrument), and save list sweep data in the file catalog ([page 67](#)).

Figure 3-4 Sweep Softkeys

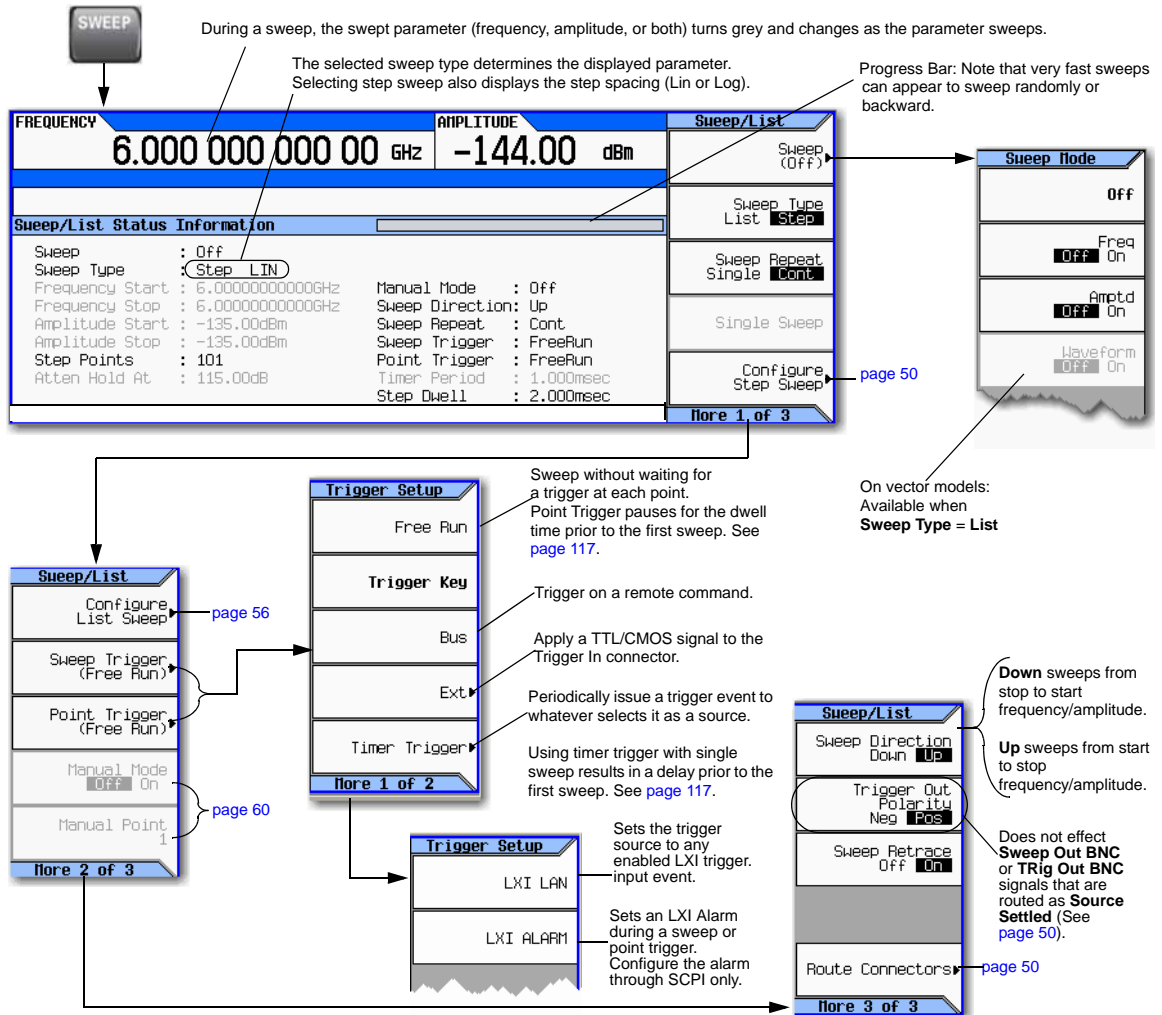

## Routing Signals

Sweep > More > More > Route Connectors

### Step Sweep

Step sweep provides a linear or logarithmic progression from one selected frequency, or amplitude, or both, to another, pausing at linearly or logarithmically spaced points (steps) along the sweep. The sweep can progress forward, backward, or be changed manually.

Figure 3-5 Step Sweep Softkeys

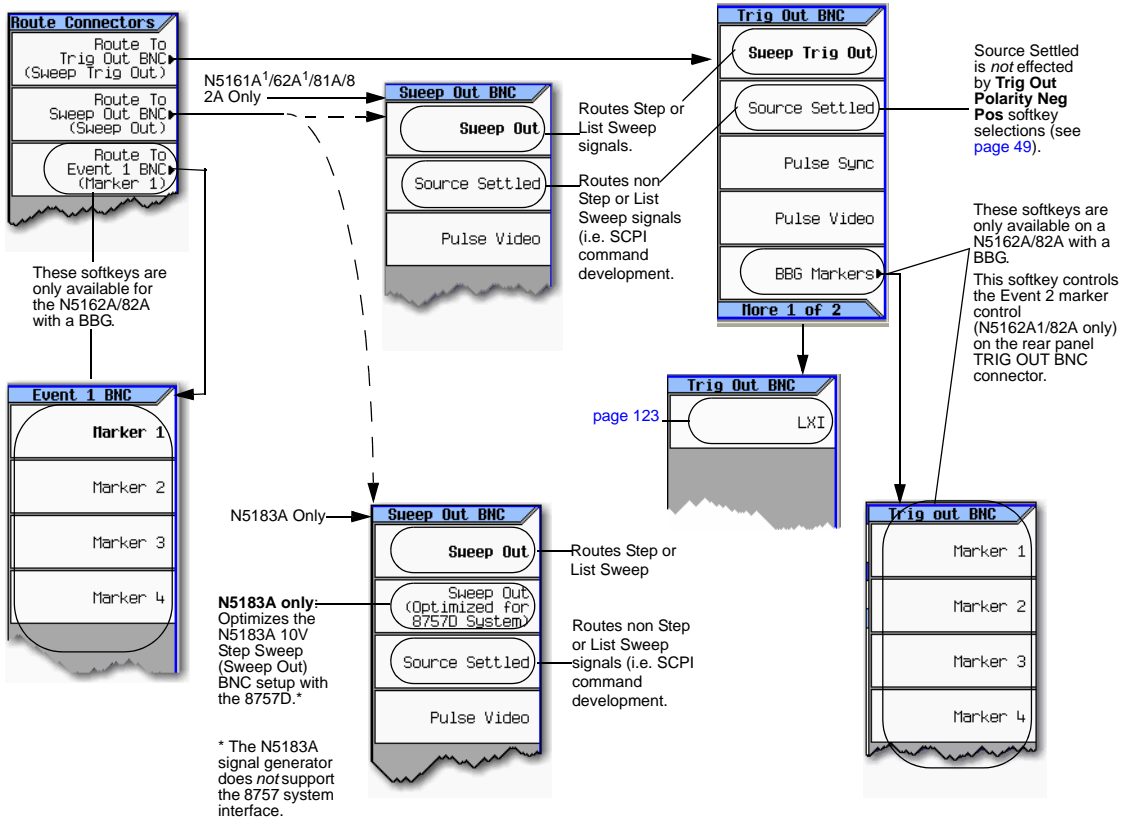

For details on each key, use key help as described on page 42.

<sup>1</sup> The N5161A and N5162A are identical to an MXG with a front panel display, except that the front panel, hardkeys and softkeys functionality are only available through SCPI commands or the Web-Enabled MXG. For information on the Web-Enabled MXG, refer to the *Installation Guide*, the *Programming Guide* and the *SCPI Command Reference*.



The N5183A allows you to use step sweep along with the frequency markers on instruments during measurements (refer to “Using Frequency Markers (N5183A Only)” on page 54).

**NOTE** The N5183A does *not* support the 8757 system interface.

**Figure 3-6 Sweep Softkeys**

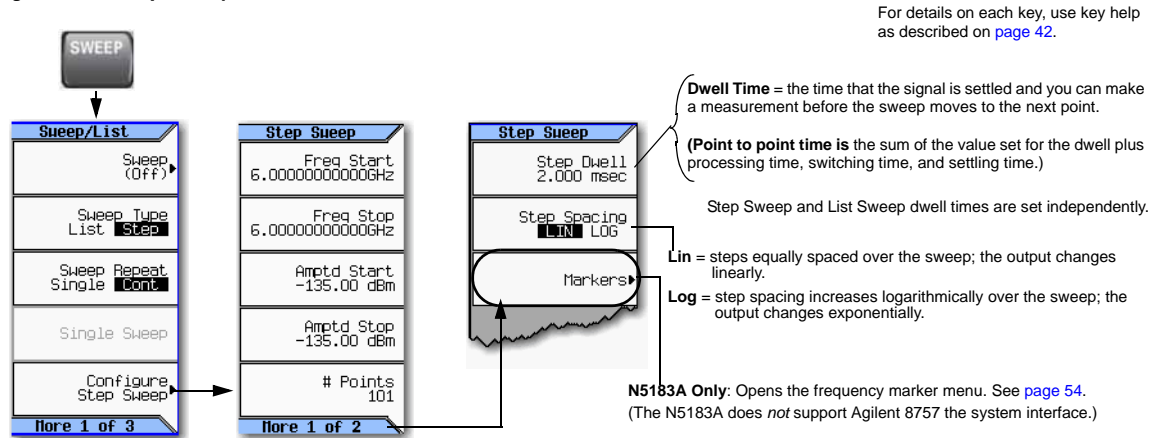

**Example: Configuring a Continuous, Linear Step Sweep**

**Output:** A signal that continuously sweeps from 500 to 600 MHz and from -20 to 0 dBm, with a dwell time of 500 ms at each of six equally-spaced points.

1. Preset the instrument and open the Sweep/List menu: Press **Preset > SWEEP**.  
Because continuous is the default sweep repeat selection, and linear is the default step spacing selection, you do not need to set these parameters.

2. Open the step sweep menu: Press **Configure Step Sweep**.

3. Set the following parameters:

Start frequency 500 MHz:	Press <b>Freq Start &gt; 500 &gt; MHz</b>
Stop frequency 600 MHz:	Press <b>Freq Stop &gt; 600 &gt; MHz</b>
Amplitude at the beginning of the sweep, -20 dBm:	Press <b>Amptd Start &gt; -20 &gt; dBm</b>
Amplitude at the end of the sweep, 0 dBm:	Press <b>Amptd Stop &gt; 0 &gt; dBm</b>
6 sweep points:	Press <b># Points &gt; 6 &gt; Enter</b>
Dwell time at each point, 500 milliseconds:	Press <b>More &gt; Step Dwell &gt; 500 &gt; msec</b>

4. Sweep both frequency and amplitude: Press **Return > Return > Sweep > Freq Off On > Amptd Off On**.

A continuous sweep begins, from the start frequency/amplitude to the stop frequency/amplitude. The SWEEP annunciator displays, and sweep progress is shown in the frequency display, the amplitude display, and the progress bar.

5. Turn the RF output on: Press **RF On/Off**.

The RF LED lights, and the continuous sweep is available at the RF Output connector.

### Using Basic Step Sweep Functions

This procedure demonstrates the following task:

- “Configuring a Frequency Sweep (N5183A only)” on page 52

### Configuring a Frequency Sweep (N5183A only)

For this example, we are going to set a step sweep using the N5183A, over a frequency range of 7.5 to 10.0 GHz, using a band-pass filter as our device under test, and display that response on a 8757D Scalar Analyzer.

1. Set up the equipment as shown in [Figure 3-7](#).

---

**NOTE** The N5183A signal generator does *not* support the 8757 system interface. Scalar analyzer settings *must* match the signal generator’s settings.

---

Figure 3-7 Equipment Setup

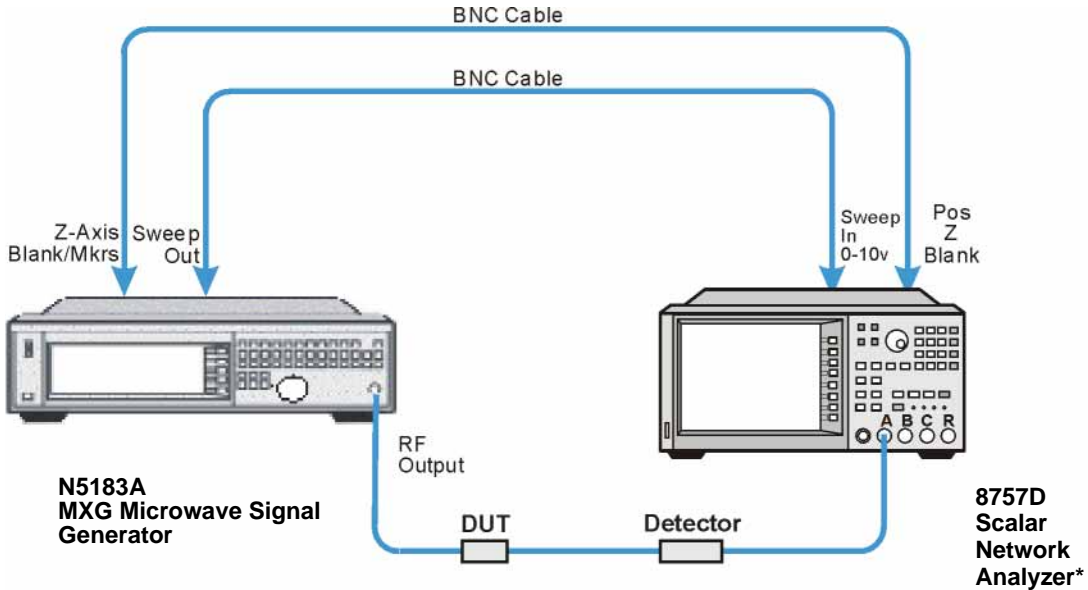

\*The N5183A signal generator is not compatible with the 8757 system interface.

2. Turn on both the 8757D and the N5183A.
3. On the 8757D:
  - a. Press **SYSTEM > MORE > SWEEP MODE** and verify that the **SYSINTF** softkey is set to OFF.

- b. Press **SYSTEM > MORE > DC**
  - c. Press **SYSTEM > Freq LABELS > START FREQ > 7.5 GHz**
  - d. Press **SYSTEM > FREQ LABELS > STOP FREQ > 10.0 GHz**
  - e. Press **SYSTEM > TRACE # POINTS > 801**
4. On the N5183A:
- a. Change the connector routing to 8757D System, enabling the N5183A to provide a sweep out to the 8757D during Step sweep operations. Press **Sweep > More > More > Route Connectors > Route to Sweep Out BNC > Sweep Out (Optimized for 8757D System)**.
  - b. Press **Sweep > Configure Step Sweep > # Points > 801**
  - c. Press **Sweep > Configure Step Sweep > Freq Stop > 10.0 GHz**
  - d. Press **Sweep > Configure Step Sweep > Freq Start > 7.5 GHz**
  - e. Press **Sweep > Sweep > Freq On Off** set to **On**

---

**NOTE** During swept RF output, the **FREQUENCY** and/or **AMPLITUDE** areas of the signal generator's display are *greyed out*, depending on what is being swept. In this case, since frequency is being swept the **FREQUENCY** area of the display is greyed out.

---

5. On the 8757D: Adjust the settings for start and stop frequency response of the device under test (DUT) so it is clearly seen on the 8757D display.
- You may need to rescale the response on the 8757D for a more accurate evaluation of the amplitude. [Figure 3-8 on page 54](#) shows an example of a bandpass filter response.

Figure 3-8 Bandpass Filter Response on 8757D

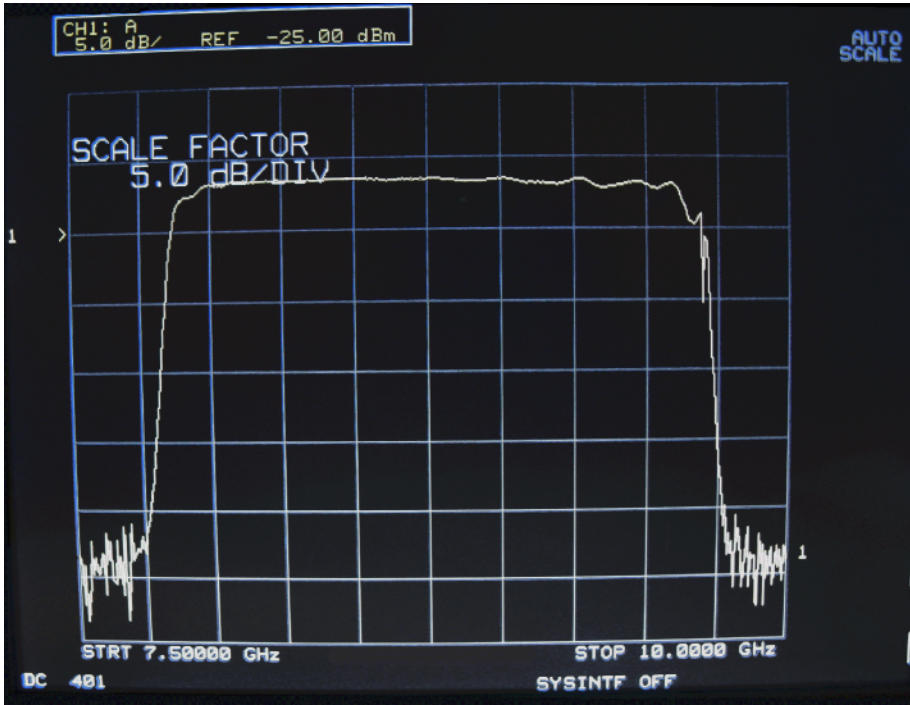

**Using Frequency Markers (N5183A Only)**

In step sweep mode, you can use the N5183A to create up to 20 frequency markers to display on your measurement equipment.

---

**NOTE** The N5183A does *not* support the 8757 system interface.

---

Figure 3-9 Frequency Marker Softkeys

Sweep > Configure Step Sweep >  
More > Markers

For details on each key, use key help  
as described on page 42.

FREQUENCY		AMPLITUDE		Markers	
40.000 000 000 00 GHz		-20.00 dBm		Marker Freq	
Frequency Start: 40.000000000GHz		Step Points: 101		Marker On/Off	
Frequency Stop : 40.000000000GHz				Delta Ref Set	
Marker	Marker Frequency	On/Off	Ref	Turn Off Markers	
0	40.0000000000 GHz	OFF	---	Marker Delta Off On	
1	40.0000000000 GHz	OFF	---	More 1 of 2	
2	40.0000000000 GHz	OFF	---		
3	40.0000000000 GHz	OFF	---		
4	40.0000000000 GHz	OFF	---		
5	40.0000000000 GHz	OFF	---		
6	40.0000000000 GHz	OFF	---		
7	40.0000000000 GHz	OFF	---		

- Marker Freq: Sets the frequency for the marker number highlighted. Up to 20 frequency markers can be set.
- Marker On/Off: Enables the selected frequency marker.
- Delta Ref Set: Selects the highlighted marker as the frequency reference marker for the rest of the frequency markers.
- Turn Off Markers: If the Delta Ref Set softkey has been pressed, this softkey enables the Marker Delta function and uses the Ref marker as the frequency marker reference for the other markers.
- Marker Delta Off On: Enables the Marker Delta function and uses the Ref marker as the frequency marker reference for the other markers.

Markers	
Marker->Center Freq	Marker->Center Freq
M1->Start M2->Stop	M1->Start M2->Stop
Amplitude Markers Off On	Amplitude Markers Off On
Marker Amplitude 2.00 dB	Marker Amplitude 2.00 dB

- Marker->Center Freq: Sets the center frequency of the sweep to the value of the highlighted marker (row).
- M1->Start  
M2->Stop: Sets the start frequency of the sweep to the value of marker 1 (M1) and the stop frequency to the value of marker 2 (M2).
- Amplitude Markers Off On: Sets the marker's amplitude value displayed on the instrument (Range: -10 dB to 10 dB).
- Marker Amplitude 2.00 dB: Sets the marker's amplitude value displayed on the instrument (Range: -10 dB to 10 dB).

## List Sweep

List sweep enables you to enter frequencies and amplitudes at unequal intervals in nonlinear ascending, descending, or random order. List sweep also enables you to copy the current step sweep values, include a waveform in a sweep (on a vector instrument), and save list sweep data in the file catalog (page 67). Dwell time is editable at each point. For fastest switching speeds, use list sweep.

Figure 3-10 List Sweep Configuration Softkeys and Display

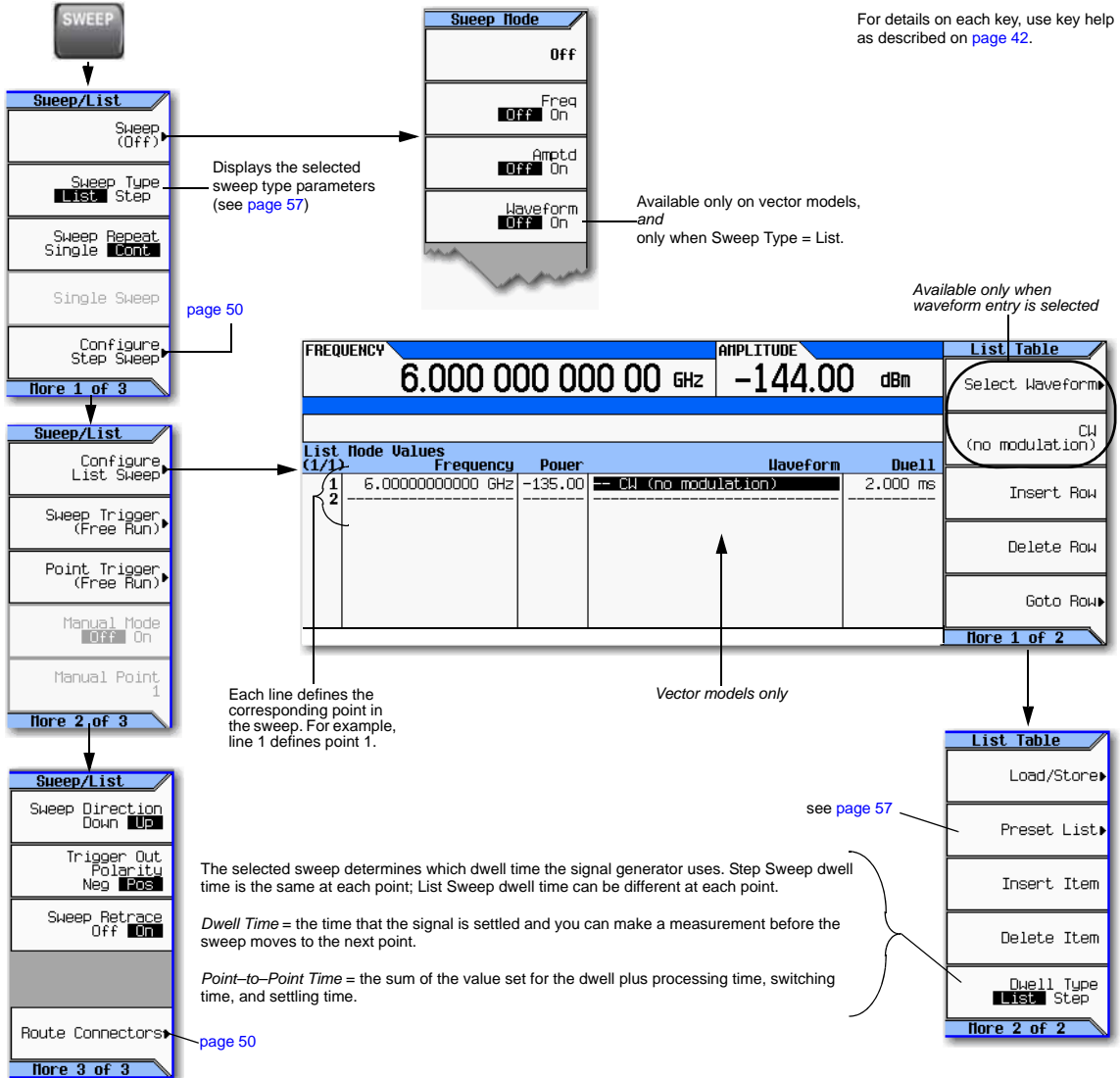

**Example: Configuring a List Sweep Using Step Sweep Data**

1. Set up the desired step sweep, but do not turn the sweep on. This example uses the step sweep configured on [page 51](#).
2. In the SWEEP menu, change the sweep type to list:  
Press **SWEEP > Sweep Type List Step** to highlight List.

The display shows sweep list parameters, as shown below.

FREQUENCY		AMPLITUDE		Sweep/List	
6.000 000 000 00 GHz		-144.00 dBm		Sweep (Off) ▶	
Sweep/List Status Information					
Sweep : Off		Current Point : 0/1		Sweep Type List Step	
Sweep Type : List		Sweep Speed : Opts/sec		Sweep Repeat Single Cont	
Frequency Points: 1		Manual Mode : Off		Single Sweep	
Amplitude Points: 1		Sweep Direction: Up		Configure Step Sweep ▶	
Waveform Points : 1		Sweep Repeat : Cont		More 1 of 3	
Dwell Points : 1		Sweep Trigger : FreeRun			
Dwell Type : List		Point Trigger : FreeRun			
Atten Hold At : 115.00dB		Timer Period : 1.000msec			
		Step Dwell : 500.000msec			

3. Open the List Sweep menu: Press **More > Configure List Sweep**.
4. Clear any previously set values from the menu and load the points defined in the step sweep into the list: Press **More > Preset List > Preset with Step Sweep > Confirm Preset**.

The display updates with the values loaded from the step sweep, as shown.

FREQUENCY		AMPLITUDE		List Table	
6.000 000 000 00 GHz		-144.00 dBm		Load/Store ▶	
List Node Values (1/1)					
	Frequency	Power	Waveform	Dwell	Preset List ▶
1	500.0000000000 MHz	-20.00	-- CW (no modulation)	500.000 ms	Insert Item
2	520.0000000000 MHz	-16.00	-- CW (no modulation)	500.000 ms	Delete Item
3	540.0000000000 MHz	-12.00	-- CW (no modulation)	500.000 ms	Dwell Type List Step
4	560.0000000000 MHz	-8.00	-- CW (no modulation)	500.000 ms	More 2 of 2
5	580.0000000000 MHz	-4.00	-- CW (no modulation)	500.000 ms	
6	600.0000000000 MHz	+0.00	-- CW (no modulation)	500.000 ms	
7			Waveforms are available only on vector models.		

**Vector Models:**

Presetting the list clears any previously selected waveforms.

For information on selecting a list sweep waveform, see [Example: Editing List Sweep Points](#) on page 58.

5. Sweep frequency and amplitude: Press **SWEEP (hardkey) > Sweep > Freq Off On > Amptd Off On**.  
Setting the sweep turns on the sweep function; a continuous sweep begins. On the display, the SWEEP annunciator appears, and the progress bar shows the progression of the sweep.
6. If not already on, turn the RF output on: Press **RF On/Off**.  
The RF Output LED lights, and a continuous sweep is available at the RF OUTPUT connector.

**Example: Editing List Sweep Points**

If you are not familiar with table editors, refer to [page 44](#).

1. Create the desired list sweep. This example uses the list sweep created in the previous example.
2. If sweep is on, turn it off. Editing list sweep parameters with sweep on can generate an error.
3. Ensure that the sweep type is set to list: Press **SWEEP > Sweep Type List Step** to highlight List.
4. In the List Mode Values table editor, change the point 1 dwell time (defined in row 1) to 100 ms:
  - a. Press **More > Configure List Sweep**.
  - b. Highlight the point 1 dwell time.
  - c. Press **100 > msec**.

The next item in the table (the frequency value for point 2) highlights.

5. Change the selected frequency value to 445 MHz: Press **445 > MHz**.
6. Add a new point between points 4 and 5: Highlight any entry in row 4 and press **Insert Row**.

This places a copy of row 4 below row 4, creating a new point 5, and renumbers subsequent rows.

7. Shift frequency values down one row, beginning at point 5: Highlight the frequency entry in row 5, then press **More > Insert Item**.

This places a copy of the highlighted frequency value in row 6, shifting the original frequency values for rows 6 and 7 down one row. The new row 8 contains only a frequency value (the power and dwell time entries do not shift down).

8. Change the still active frequency value in row 5 to 590 MHz: Press **590 > MHz**. The power in row 5 is now the active parameter.
9. Insert a new power value (-2.5 dBm) for point 5, and shift down the original power values for points 5 and 6 by one row: Press **Insert Item > -2.5 > dBm**.
10. To complete the entry for point 8, insert a duplicate of the point 7 dwell time by shifting a copy of the existing value down: Highlight the dwell time in row 7 and press **Insert Item**.
11. *For an analog instrument, go to step 14.* For a vector instrument, continue with step 12.
12. Select a waveform for point 2:
  - a. Highlight the waveform entry for point 2 and press the **More > Select Waveform**.

The signal generator displays the available waveforms, as shown in the following example.

Select (1/1)	Segment On Bkg Media	Points	Sequence On Int Media	Segs
	RAMP_TEST_WFM	200	A	4
	SINE_TEST_WFM	200		

- b. Highlight the desired waveform (in this example, SINE\_TEST) and press either the **Select** hardkey or the **Select Waveform** softkey.



13. As desired, repeat step 12 for the remaining points for which you want to select a waveform. The following figure shows an example of how this might look.

FREQUENCY		AMPLITUDE		List Table		
6.000 000 000 00 GHz		-144.00 dBm		Edit Item		
List Node Values (1/1)						
List	Node	Frequency	Power	Waveform	Dwell	
1		500.0000000000 MHz	-20.00	-- CW (no modulation)	100.000 ms	Insert Row
2		445.0000000000 MHz	-16.00	WFM1:SINE_TEST_WFM	500.000 ms	
3		540.0000000000 MHz	-12.00	-- CW (no modulation)	500.000 ms	Delete Row
4		560.0000000000 MHz	-8.00	-- CW (no modulation)	500.000 ms	
5		590.0000000000 MHz	-2.50	WFM1:RAMP_TEST_WFM	500.000 ms	Goto Row
6		560.0000000000 MHz	-8.00	WFM1:RAMP_TEST_WFM	500.000 ms	
7		580.0000000000 MHz	-4.00	-- CW (no modulation)	500.000 ms	
8		600.0000000000 MHz	+0.00		500.000 ms	
9						
Page 1 of 2						

The empty entry is equivalent to choosing CW (no modulation).

14. Turn sweep on:

Press **Return** > **Return** > **Return** > **Sweep** > **Freq Off On** > **Amptd Off On** > **Waveform Off On**.

15. If it is not already on, turn the RF output on:

Press **RF On/Off**.

The SWEEP annunciator appears on the display, indicating that the signal generator is sweeping, and the progress bar shows the progression of the sweep.

**NOTE** If the instrument is in manual sweep (page 60), the active row (row 6 in the figure above) is the selected (manual) point, and the signal generator outputs the settings for that selection when the RF output is on.

### Example: Using a Single Sweep

1. Set up either a step sweep (page 51) or a list sweep (page 57).

2. In the List/Sweep menu, set the sweep repeat to single:

Press **Sweep Repeat Single Cont** to highlight Single.

Sweep does not occur until you trigger it.

Note that the WINIT annunciator appears on the display, indicating that the sweep is waiting to be initiated.

3. If not already on, turn the RF output on: Press **RF On/Off**.

4. Initiate the sweep: Press **Single Sweep**.

A single repetition of the configured sweep is available at the RF Output connector.

As the signal generator sweeps, the SWEEP annunciator replaces WINIT on the display, and the progress bar shows the progression of the sweep.

At the end of the sweep, there is no progress bar, and the WINIT annunciator replaces SWEEP.

### Example: Manual Control of Sweep

1. Set up either a step sweep (page 51) or a list sweep (page 57).
2. In the Sweep/List menu, select a parameter to sweep: Press **Sweep** > *parameter* > **Return**.
3. Select manual mode: Press **More** > **Manual Mode Off On**.

When you select manual mode, the current sweep point becomes the selected manual point.

4. If it is not already on, turn the RF output on: Press **RF On/Off**.
5. Select the desired point to output: Press **Manual Point** > *number* > **Enter**.

The progress bar changes to indicate the selected point.

6. Use the knob or arrow keys to move from point to point. As you select each point, the RF output changes to the settings in that selection.

The SWMAN annunciator indicates that the sweep is in manual mode.

The currently sweeping parameter stops and displays the selected point.

When you enter a manual point, the progress bar moves to and stops at the selected point.

The parameters of the selected sweep point (point 3 of 6 in this example) define the signal available at the RF Output connector.

When you turn manual mode on, the current sweep point becomes the manual point.

FREQUENCY	AMPLITUDE	Sweep/List
540.000 000 00 MHz	-144.00 dBm	Configure List Sweep ▶
<b>SWMAN</b>		Sweep Trigger (Free Run) ▶
Manual Point: 3		Point Trigger (Free Run) ▶
<b>Sweep/List Status Information</b>		Manual Mode Off <b>On</b>
Sweep : Freq	Current Point : 3/6	Manual Point 3
Sweep Type : Step LIN	Sweep Speed : Opts/sec	More 2 of 3
Frequency Start : 500.00000000MHz	Manual Mode : On	
Frequency Stop : 600.00000000MHz	Sweep Direction: Up	
Amplitude Start : -20.00dBm	Sweep Repeat : Cont	
Amplitude Stop : 0.00dBm	Sweep Trigger : FreeRun	
Step Points : 6	Point Trigger : FreeRun	
Atten Hold At : 115.00dB	Timer Period : 1.000msec	
	Step Dwell : 500.000msec	

## Modulating the Carrier Signal

To modulate the carrier signal, you must have both

- an active modulation format *and*
- modulation of the RF output enabled

### Example

1. Preset the signal generator.
2. Turn on AM modulation: Press **AM** > **AM Off On** (requires Option UNT).

You can turn on the modulation format before or after setting signal parameters.

The modulation format generates, but does not yet modulate the carrier signal.

Once the signal generates, an annunciator showing the name of the format appears, indicating that a modulation format is active.

3. Enable modulation of the RF output: Press the **Mod On/Off** key until the LED lights.

If you enable modulation without an active modulation format, the carrier signal does not modulate until you subsequently turn on a modulation format.

Annunciator indicates active AM modulation

Mod	State	Depth/Dev	Source	Rate	Waveform
AM	Mod Off	0.1%	Internal	400.0Hz	Sine
FM	Off	1.0000kHz	Internal	400.0Hz	Sine
PM	Off	0.000rad	Internal	400.0Hz	Sine
Pulse	Off	1.00us	Internal	2.00us	Free-Run
Burst	Off		Int		
I/Q	Off		Internal		

**NOTE** To turn modulation *off*, press the **Mod On/Off** key until the LED turns off.

When the **Mod On/Off** key is off, the carrier signal is not modulated, even with an active modulation format.

4. To make the modulated carrier available at the RF output connector, press the **RF On/Off** key until the LED lights.

**See also:** [“Using Analog Modulation \(Option UNT Only\)” on page 75](#)  
[“Using Pulse Modulation \(Option UNU or UNW or 320\)” on page 127](#)  
[“I/Q Modulation” on page 200](#)

## Simultaneous Modulation

**NOTE** The Agilent MXG is capable of simultaneous modulation. All modulation types (AM, FM,  $\phi$ M, and Pulse) may be simultaneously enabled. But, there are some exceptions. Refer to [Table 3-1](#).

**Table 3-1 Simultaneous Modulation Type Combinations**

	AM <sup>a</sup>	FM	$\phi$ M	Pulse <sup>b</sup>
AM	--	x	x	x
FM	x <sup>c</sup>	--	<i>not applicable</i>	x
$\phi$ M	x <sup>c</sup>	<i>not applicable</i>	--	x
Pulse	x	x	x	--

<sup>a</sup>Linear AM and Exponential AM *cannot* be enabled simultaneously. Refer to [Chapter 4](#).

<sup>b</sup>Pulse modulation requires Option UNU or UNW. Refer to [Chapter 6](#).

<sup>c</sup>FM and  $\phi$ M *cannot* be enabled simultaneously.

## Working with Files

- [File Softkeys](#) on page 63
- [Viewing a List of Stored Files](#) on page 64
- [Storing a File](#) on page 65
- [Loading \(Recalling\) a Stored File](#) on page 67
- [Moving a File from One Media to Another](#) on page 68
- [Working with Instrument State Files](#) on page 69
- [Selecting the Default Storage Media](#) on page 73

The signal generator recognizes several types of files, such as instrument state files, license files, and list sweep files. Files can be stored either in the signal generator's internal storage or on the USB media. This section provides an overview of how to navigate the signal generator's file menus, and how to view, store, load, and move files.

The Agilent MXG non-volatile internal memory is allocated according to a Microsoft compatible file allocation table (FAT) file system. Refer to the *Programming Guide*.

See also: [Storing, Loading, and Playing a Waveform Segment](#) on page 144.

# File Softkeys

For details on each key, use key help as described on page 42.

**Note:** Available file types depend on the installed options.

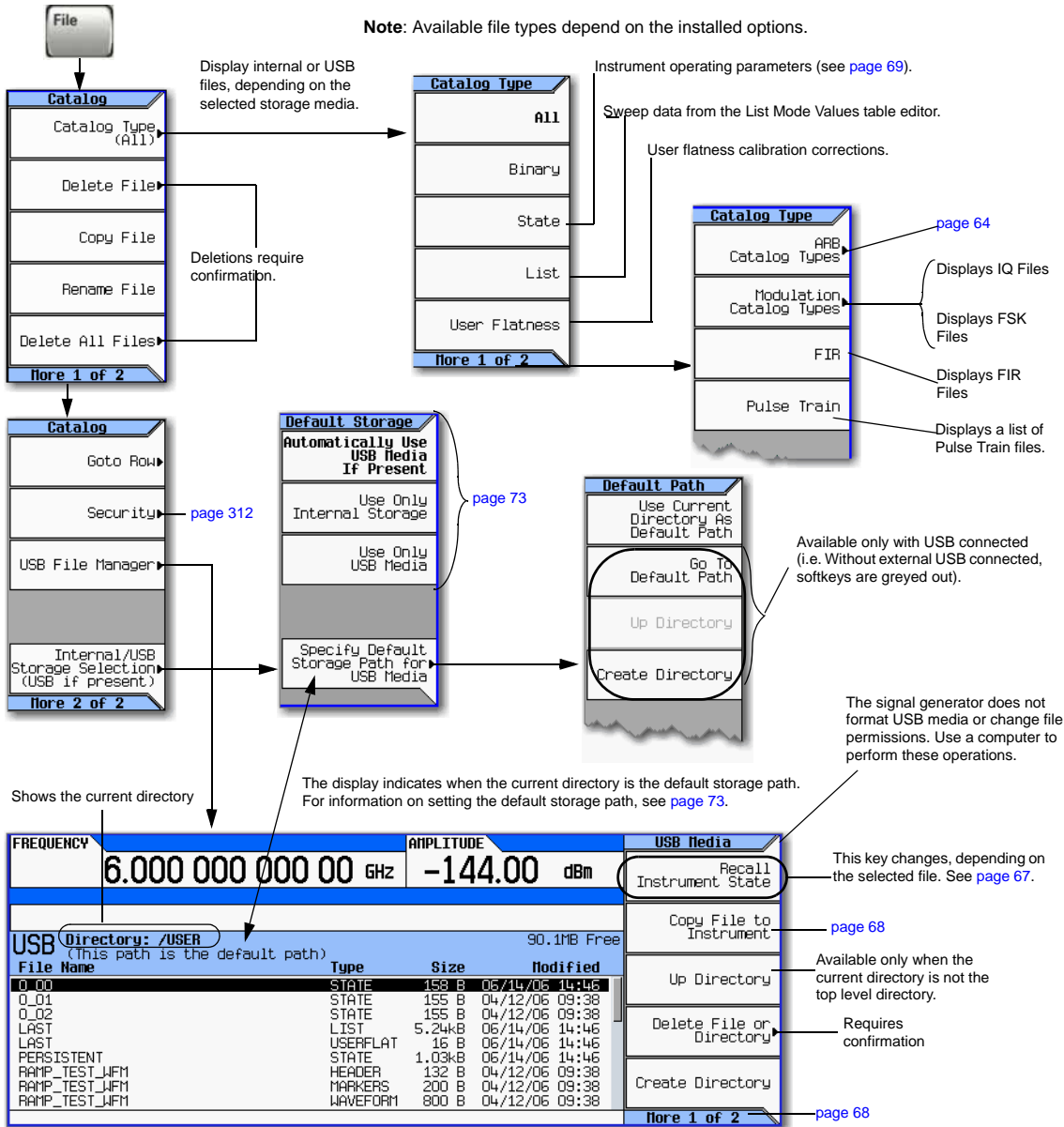

When you connect USB media to the instrument, the signal generator displays the USB Media menu and the message **External USB Storage attached**. When you disconnect the USB media, the message **External USB Storage detached** displays. When you open the External Media menu without USB media connected, the signal generator displays the message **External Media Not Detected**.

### ARB File Softkeys

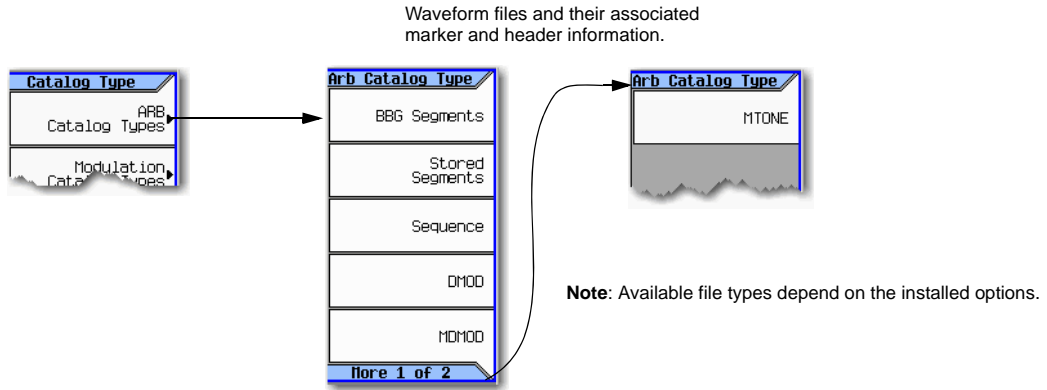

For details on each key, use key help as described on [page 42](#).

### Viewing a List of Stored Files

The information in this section is provided with the assumption that default storage media is set to Auto, as described on [page 73](#).

#### Viewing a List of Files Stored in the Signal Generator

1. If USB media is connected, disconnect it. The signal generator's storage media switches to internal, so you can now use the file catalogs to see files stored in the signal generator.
2. Select the desired file catalog: Press **> Catalog Type > desired catalog** (in this example, **All**). The selected files appear in alphabetical order by file name, as shown in the following figure.

The selected file catalog and the storage media

FREQUENCY		AMPLITUDE		Catalog	
6.000 000 000 00 GHz		-144.00 dBm		Catalog Type (All) ▶	
				Delete File ▶	
Catalog of All Files in Int Storage				30.5MB used 467MB free	
	File Name	Type	Size	Modified	
1	123456789_2345789_12345	LIST	5889	06/07/06 10:34	Copy File
2	12TONE_WFM	SNVWFM	10752	09/22/06 22:36	
3	1A	SEQ	539	10/31/06 09:15	Rename File
4	2_00	STATE	201	11/02/06 10:05	
5	BOGUS	LIST	69	09/22/06 22:36	Delete All Files ▶
6	BOGUS	NVMKR	69	10/09/06 14:41	
7	BOGUSII	LIST	69	09/22/06 22:36	
8	CDMA2K_9CHAN_WFM	SNVWFM	1474752	09/22/06 22:36	
9	CDMA2K_PILOT_WFM	SNVWFM	1474752	09/22/06 22:36	
10	DISPLAY.BMP	BINARY	76918	09/22/06 22:36	
More 1 of 2					

### Viewing a list of Files Stored on USB Media

With USB media connected, you can view files on USB media using either the file catalogs, which can display only a selected type of file, or the USB File Manager, which displays all files.

Using the File Catalogs:

- With the USB media connected, select the desired file catalog: press **> Catalog Type > desired catalog**. The selected files appear in alphabetical order by file name.

Using the USB File Manager:

- With USB media connected, open the USB File Manager: press **File > More > USB File Manager**. The instrument displays the default directory on the USB Media, as shown in the following figure. Note that when you attach USB media, the display goes directly to this menu.

Use the **Page Up** and **Page Down** hardkeys to scroll through the contents of the directory.

FREQUENCY		AMPLITUDE		USB Media	
6.000 000 000 00 GHz		-144.00 dBm		Recall Instrument State	
USB Directory: /USER (This path is the default path) 90.1MB Free				Copy File to Instrument	
File Name	Type	Size	Modified	Up Directory	
0_00	STATE	158 B	06/14/06 14:46	Delete File or Directory	
0_01	STATE	155 B	04/12/06 09:38	Create Directory	
0_02	STATE	155 B	04/12/06 09:38		
LAST	LIST	5.24kB	06/14/06 14:46		
LAST	USERFLAT	16 B	06/14/06 14:46		
PERSISTENT	STATE	1.03kB	06/14/06 14:46		
RAMP_TEST_WFM	HEADER	132 B	04/12/06 09:38		
RAMP_TEST_WFM	MARKERS	200 B	04/12/06 09:38		
RAMP_TEST_WFM	WAVEFORM	800 B	04/12/06 09:38		
				More 1 of 2	

### Storing a File

Several menus enable you to store instrument parameters. For example, you can store instrument states, lists, and waveforms.

- An instrument state file contains instrument settings. For this type of file, use the **Save** hardkey shown in [Figure 3-11 on page 69](#).
- For other types of data, use the **Load/Store** softkey (shown below) that is available through the menu used to create the file.

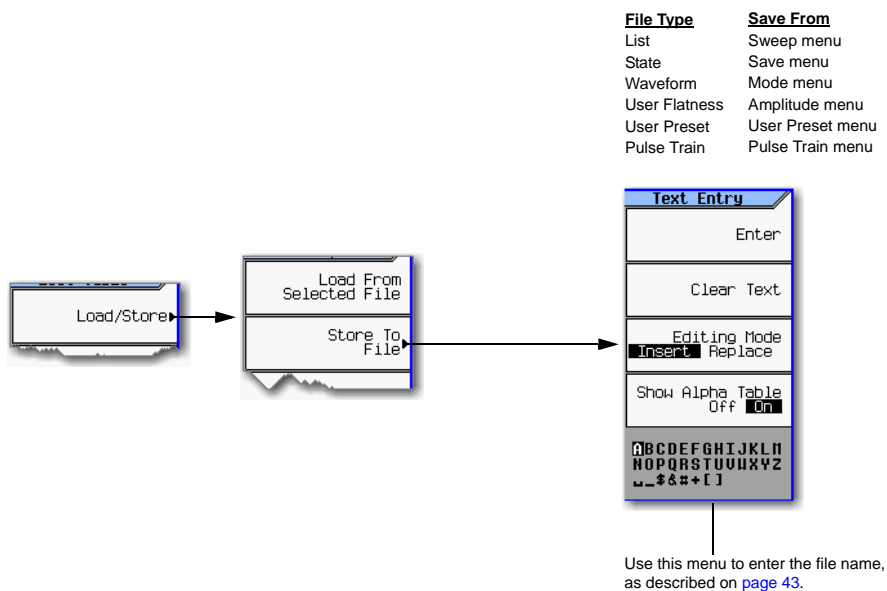

For details on each key, use key help as described on [page 42](#).

**File Length** (including extension)  
Internal Media: 25 characters  
USB Media: 39 characters



## Loading (Recalling) a Stored File

There are several ways to load (recall) a stored file.

- For an instrument state file, use the **Recall** hardkey shown in [Figure 3-11 on page 69](#).
- For other types of data, use the Load/Store softkey (shown below) that is available through the menu used to create the file.

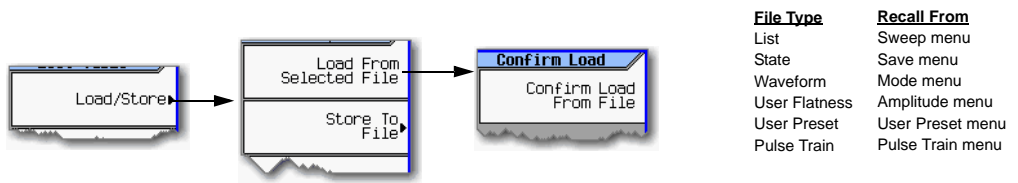

## Loading a File From USB Media

To load a file from USB media, use the USB file manager shown below.

**File > Catalog Type <type> > More > USB File Manager**

or

**File > More > USB File Manager**

or

Insert the USB media

File Type	Extension	Pressing Select with file highlighted...
List	.list	loads list and starts sweep
State	.state	load instrument state
Waveform	.waveform	loads and plays waveform
User Flatness	.uflat	loads and applies user flatness
User Preset	.uprst	loads and executes user preset
License	.lic	installs purchased license
Pulse Train	.ptrain	loads and applies pulse train

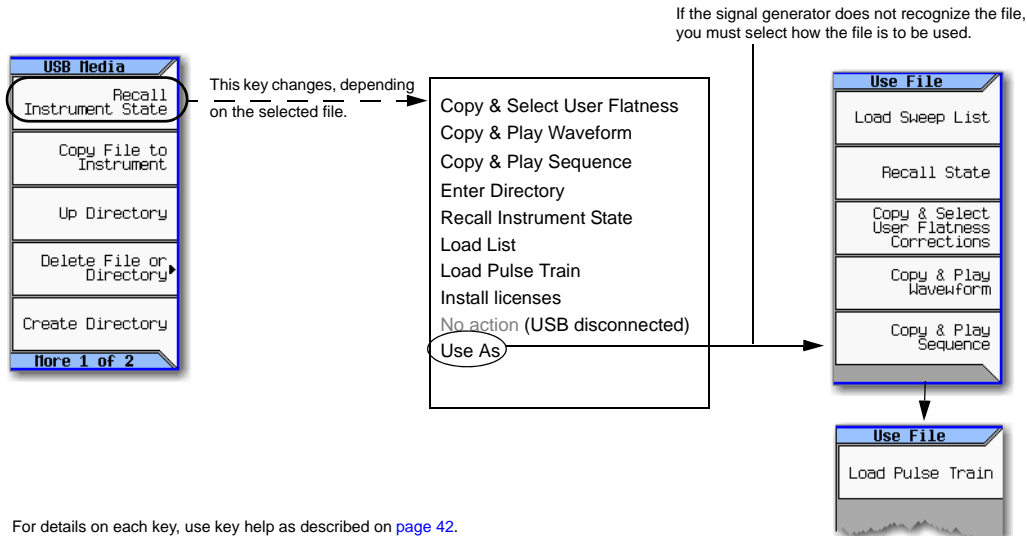

For details on each key, use key help as described on [page 42](#).

## Moving a File from One Media to Another

Use the USB Media Manager to move files between USB and internal media.

File > Catalog Type > <type> > More > USB File Manager

or

File > More > USB File Manager

or

Insert the USB Flash Drive (UFD)

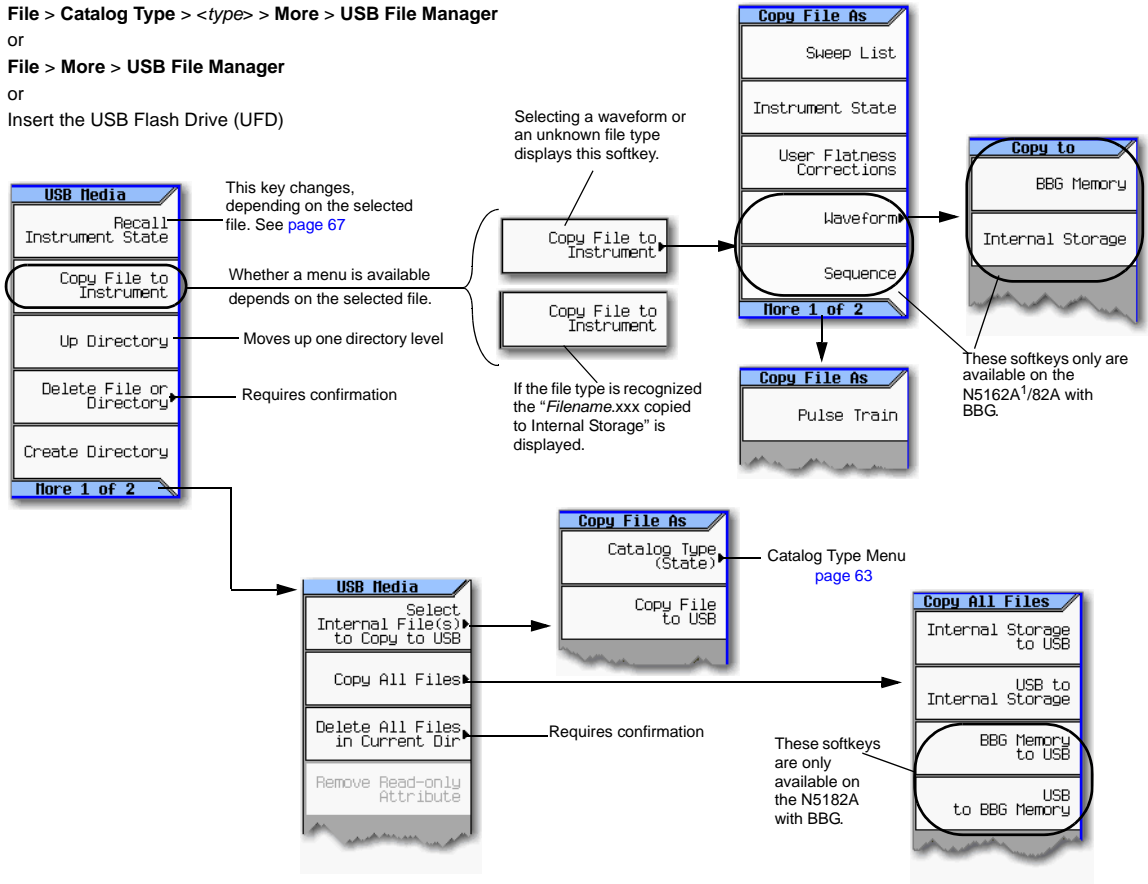

<sup>1</sup> The N5162A is identical to an MXG with a front panel display, except that the front panel, hardkeys and softkeys functionality are only available through SCPI commands or the Web-Enabled MXG. For information on the Web-Enabled MXG, refer to the *Installation Guide*, the *Programming Guide* and the *SCPI Command Reference*.

For details on each key, use key help as described on [page 42](#).

## Working with Instrument State Files

- [Saving an Instrument State](#) on page 70
- [Saving a User Preset](#) on page 70
- [Recalling an Instrument State](#) on page 70
- [Recalling an Instrument State and Associated Waveform File](#) on page 71
- [Recalling an Instrument State and Associated List File](#) on page 71
- [Moving or Copying a Stored Instrument State](#) on page 72

**Figure 3-11 Save and Recall Softkeys**

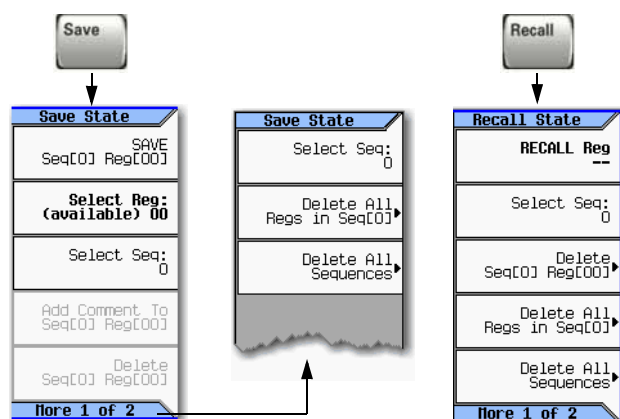

For details on each key, use key help as described on [page 42](#).

When saved to the signal generator, instrument settings (states) save to instrument state memory\*. Instrument state memory is divided into 10 sequences (0 through 9); each sequence comprises 100 registers (00 through 99).

Delete softkeys in the **Save** and **Recall** menus enable you to delete the contents of a specific register, or the contents of all sequences in the state file catalog.

The signal generator requires that you confirm a deletion.

### \*Caution

To avoid the loss of data, GPIB settings, or current user instrument states that have not been permanently saved to non-volatile memory, the MXG should always be powered down either via the MXG's front panel power button or the appropriate SCPI command. MXG's installed in rack systems and powered down with the system rack power switch, rather than the MXG's front panel switch display a Error -310 due to the MXG not being powered down correctly.

### The following information is *not* stored in a state file:

System Security Level	Sweep lists	Hostname	Remote Language	Step increment values
System Security Level Display	Pulse Train lists	IP Address	FTP Server	ARB Files
System Security Level State	Display State On/Off	Subnet Mask	Manual DHCP	MAC
Web Server (HTTP)	Files	Default Gateway	VXI-11 SCPI	User Power Correction
Sockets SCPI (TELNET)	I/Q Calibration Data			

### Saving an Instrument State

1. Preset the signal generator and set the following:
  - Frequency: 800 MHz
  - Amplitude: 0 dBm
  - RF: on
2. (Optional, vector models only) Associate a waveform file with these settings:
  - a. Press **Mode > Dual ARB > Select Waveform**.
  - b. Highlight the desired file and press **Select Waveform**. If the file is not listed, you must first move it from internal or external media to BBG media, see [page 144](#).
3. Select the desired memory sequence (for this example, 1): Press **Save > Select Seq > 1 > Enter**.
4. Select the desired register (in this example, 01): Press **Select Reg > 1 > Save Reg**.

If a waveform is currently selected, saving the instrument state also saves a pointer to the waveform file *name*.

5. Add a descriptive comment to sequence 1 register 01:

Press **Add Comment to Seq[1] Reg[01]**, enter the comment and press **Enter**. The comment appears in the Saved States list when you press **Recall**. If the instrument state has an associated waveform, entering the waveform name in the comment makes it easy to identify which instrument state applies to which waveform.

### Saving a User Preset

A user preset is a special type of instrument state file.

1. Preset the signal generator and set as desired.
2. Press **User Preset > Save User Preset**.

This saves a state file named USER\_PRESET, which the signal generator recognizes as containing user preset information.

You can set up several preset conditions under different names:

1. After you save a user preset, rename it to something other than USER\_PRESET (see [page 72](#)).
2. Save as many user presets as you wish, renaming the USER\_PRESET file each time.
3. Give the desired file the name USER\_PRESET.

### Recalling an Instrument State

1. Preset the signal generator.
2. Press **Recall**.

The **Select Seq** softkey shows the last sequence used, and the display lists any states stored in the registers in that sequence; **RECALL Reg** is the active entry.

3. Select the desired instrument state:

If the desired state is listed in the currently selected sequence, press *desired number* > **Enter**.  
If not, press Press **Select Seq > desired number > Enter > RECALL Reg > desired number > Enter**.

### Recalling an Instrument State and Associated Waveform File

1. Ensure that the desired waveform file exists, and that it is in BBG media ([page 144](#)).

If the waveform file is not in BBG media, this procedure generates an error.

Recalling an instrument state with an associated waveform file recalls only the waveform *name*. It does not recreate the waveform file if it was deleted, or load the file into BBG media if it is in internal or USB media.

2. Recall the desired instrument state (see previous example).
3. View the waveform file name recalled with the instrument state: press **Mode > Dual ARB**.

The name is displayed as the selected waveform.

4. Turn on the waveform file: Press **Mode > Dual ARB > ARB Off On**.

### Recalling an Instrument State and Associated List File

Recalling an instrument state recalls only the list sweep setup. It does not recall the frequency and/or amplitude values. Because you must load the list file from the file catalog, when you store a list file, be sure to give it a descriptive name (up to 25 characters).

1. Recall the desired instrument state (see previous example).
2. Load the desired list file:
  - a. Press **Sweep > More > Configure List Sweep > More > Load/Store**.
  - b. Highlight the desired file and press **Load From Selected File > Confirm Load From File**.

### Editing The Comment on an Instrument Comment

Use the following steps to change a comment on an instrument state saved using the **Save** key. This is *not* the file name that appears in the State catalog (which is the file's memory location).

1. Press **Save**
2. Highlight the desired register
3. Press **Edit Comment In Seq[n] Reg [nn]**.
4. Press **Re-SAVE Seq[n] Reg[nn]**.

This overwrites previously saved instrument state settings with the new comment.

### Moving or Copying a Stored Instrument State

Figure 3-12 Instrument State File Catalog

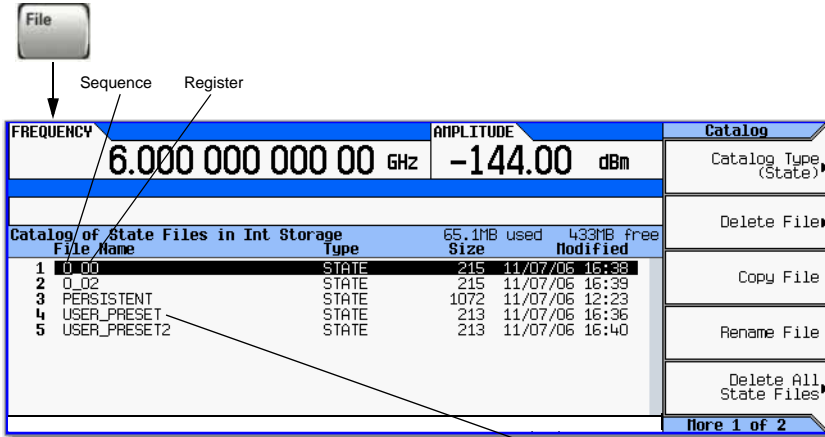

The signal generator recognizes only the file named USER\_PRESET as user preset information (page 70).

A user-created state file's default name is its memory location (sequence and register).

To move the file, rename it to the desired sequence and register; you can not give a file the same name as an existing file. If you rename a state file to something other than a valid sequence/register name, the file does not appear in either the Save or Recall menu.

## Selecting the Default Storage Media

You can configure the signal generator to store user files to either the internal storage or to external USB media. To automatically switch between USB media and internal storage, depending on whether USB media is attached, select **Automatically Use USB Media If Present**. To avoid storing any confidential information in the instrument, select **Use Only USB Media**. To avoid storing any confidential information to USB media, select **Use Only Internal Storage**.

This selection is unaffected by power-cycle or preset.

File > More >

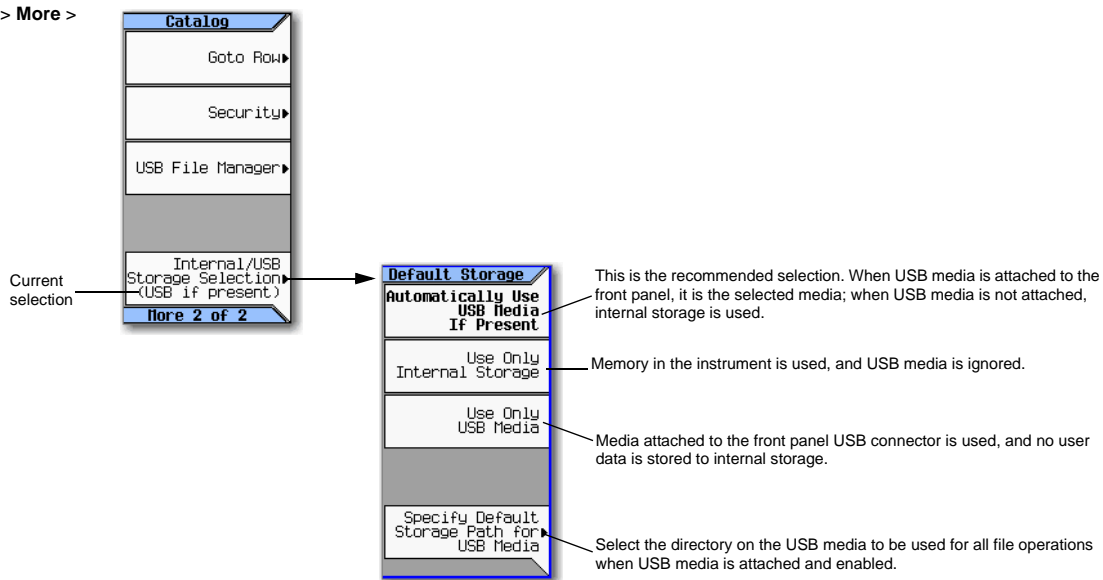

For details on each key, use key help as described on [page 42](#).

## Reading Error Messages

If an error condition occurs, the signal generator reports it to both the front panel display error queue and the SCPI (remote interface) error queue. These two queues are viewed and managed separately; for information on the SCPI error queue, refer to the *Programming Guide*.

Characteristic	Front Panel Display Error Queue
Capacity (#errors)	30
Overflow Handling	Drops the oldest error as each new error comes in.
Viewing Entries	Press: <b>Error</b> > <b>View Next</b> (or <b>Previous</b> ) <b>Error Page</b>
Clearing the Queue	Press: <b>Error</b> > <b>Clear Error Queue(s)</b>
Unresolved Errors <sup>a</sup>	Re-reported after queue is cleared.
No Errors	When the queue is empty (every error in the queue has been read, or the queue is cleared), the following message appears in the queue: No Error Message(s) in Queue 0 of 0

<sup>a</sup>Errors that must be resolved. For example, unlock.

### Error Message Format

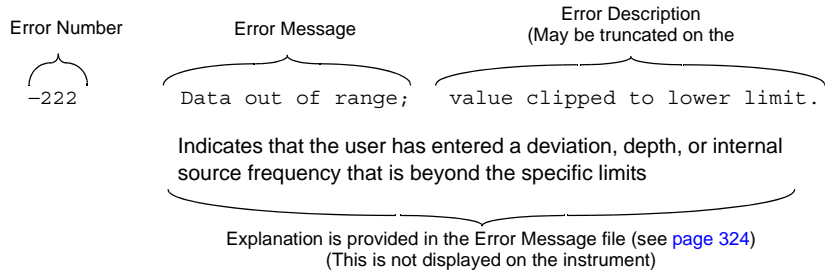

The annunciator indicates an unviewed message.

new indicates a message generated since messages were last viewed.

**Modulation Status Information**

Mod	State	Depth/Dev	Source	Rate	Wavefo
AM	Off	0.1%	Internal	400.0Hz	Sine
<b>FM</b>	<b>On</b>	<b>1.000kHz</b>	<b>Internal</b>	<b>400.0Hz</b>	<b>Sine</b>
PM	Off	0.000rad	Internal	400.0Hz	Sine
Pulse	Off	2.00us	Internal	4.00us	Free
Burst	Off		Int		
I/Q	Off		Internal		

**Error Queue**  
**ERROR: -221, Settings conflict** (new)  
 -221, Settings conflict: Enabled modulation source conflicts with previously enabled modulation source. Previous modulation disabled. 1 of 1

\*\*\*PROTO CODE \*\* NOT FOR CUSTOMER USE \*\*\*  
 04/06/2006 10:12

Error messages appear in the lower left corner of the display as they occur.



## 4 Using Analog Modulation (Option UNT Only)

**NOTE** The Mod On/Off hardkey and LED functionality are only valid for MXGs with Option UNT installed.

Before using this information, you should be familiar with the basic operation of the signal generator. If you are not comfortable with functions such as setting the power level and frequency, refer to [Chapter 3, “Basic Operation,”](#) on page 41 and familiarize yourself with the information in that chapter.

- [The Basic Procedure](#) on page 76
- [Using an External Modulation Source](#) on page 77
- [Removing a DC Offset](#) on page 77
- [Using Wideband AM](#) on page 77

**Figure 4-1 Analog Modulation Softkeys**

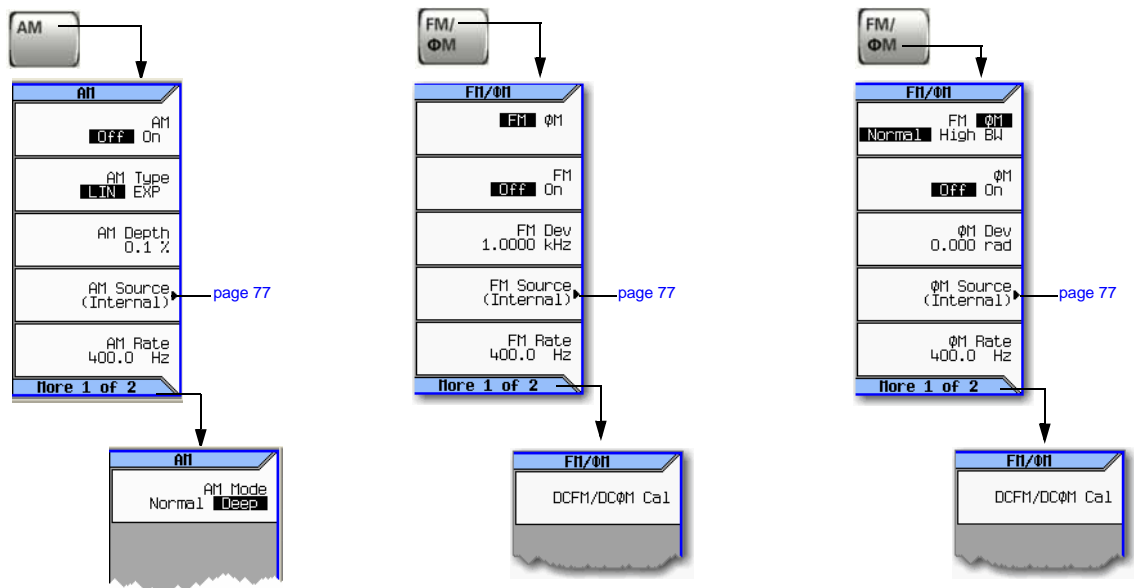

For details on each key, use key help as described on [page 42](#).

## The Basic Procedure

1. Preset the signal generator.
2. Set the carrier (RF) frequency.
3. Set the RF amplitude.
4. Configure the modulation:

AM	FM	$\Phi$ M
a. Press <b>AM</b> b. Set the AM type (Linear or Exponential): <b>AM Type</b> to highlight desired type. c. Set the AM Mode (Normal or Deep). Default is Deep. To select <b>Normal</b> enable <b>More</b> to highlight desired type. d. Set the AM Depth: <b>AM Depth</b> > <i>value</i> Default 0.01% Range 0.01 to 100% e. Set the rate: <b>AM Rate</b> > <i>value</i> > <i>frequency unit</i>	a. Press <b>FM/<math>\Phi</math>M</b> b. Set the deviation: <b>FM Dev</b> > <i>value</i> > <i>frequency unit</i> c. Set the rate: <b>FM Rate</b> > <i>value</i> > <i>frequency unit</i>	a. Press <b>FM/<math>\Phi</math>M</b> > <b>FM <math>\Phi</math>M</b> b. Set the BW (normal or high): <b>FM <math>\Phi</math>M</b> to highlight desired type c. Set the deviation: <b><math>\Phi</math>M Dev</b> > <i>value</i> > <b>pi rad</b> d. Set the rate: <b><math>\Phi</math>M Rate</b> > <i>value</i> > <i>frequency unit</i>

5. Turn on the modulation:

AM	FM	$\Phi$ M
<b>AM Off On</b> softkey to On	<b>FM Off On</b> softkey to On	<b><math>\Phi</math>M Off On</b> softkey to On

The appropriate modulation annunciator displays, indicating that you enabled modulation.

6. Turn on the RF output.

The RF output LED lights, indicating that the signal is transmitting from the RF output connector.

If the modulation does not seem to be working properly, refer to [“No Modulation at the RF Output” on page 318](#).

See also [“Modulating the Carrier Signal” on page 60](#).

## Using an External Modulation Source

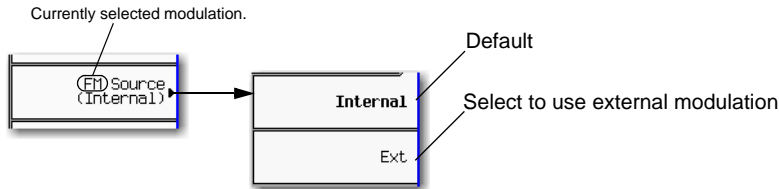

Rear panel inputs are described on [page 15](#)

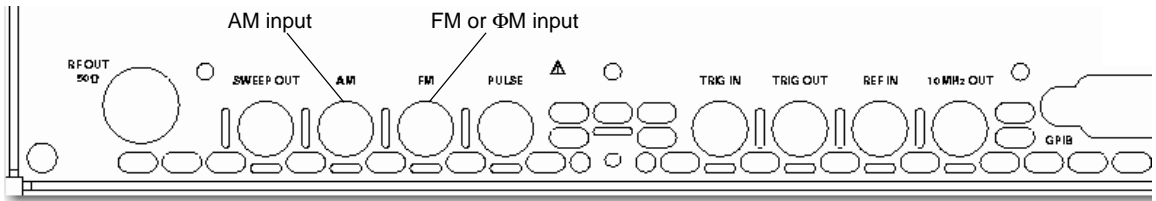

## Removing a DC Offset

To eliminate an offset in an externally applied FM or  $\Phi$ M signal, perform a DCFM or DC $\Phi$ M Calibration.

---

**NOTE** You can perform this calibration for internally generated signals, but DC offset is not usually a characteristic of an internally generated signal.

---

1. Set up and turn on the desired modulation.
2. Press **FM/ $\Phi$ M** > **More** > **DCFM/DC $\Phi$ M Cal.**

Performing the calibration with a DC signal applied removes any deviation caused by the DC signal, and the applied DC level becomes the new zero reference point. When you disconnect the DC signal, perform the calibration again to reset the carrier to the correct zero reference.

## Using Wideband AM

Wideband AM uses the I input of the I/Q modulation system. The Q input, must be biased with 1.0V. When the wideband AM is turned on, the I/Q is turned on and the I/Q source is set to external. If the I/Q is turned off or the I/Q source is set to anything other than external, then the wideband AM turns off.

Figure 4-2 Wideband AM Softkey Menu

AM > More

Modulation Status Information					
Mod	State	Depth/Dev	Source	Rate	Waveform
AM WB	On	0.1%	I Input	400.0Hz	Sine
FM	Off	1.0000kHz	Internal	400.0Hz	Sine
QM	Off	0.000rad	Internal	400.0Hz	Sine
Pulse Burst	Off	2.00us	Internal	4.00us	Free-Run
I/Q	On		External		

When the Wideband AM is enabled, these fields are active.

Enables and disables the wideband AM feature.  
Note: If the I/Q is turned off or the I/Q source is set to anything other than external, then the wideband AM turns off.

For details on each key, use key help as described on [page 42](#).

### Setting the Wideband AM

1. Set up and enable the desired modulation type.
2. Press **AM > More > AM WB** to **On**

---

## 5 Optimizing Performance

---

**NOTE** For the N5161A/62A the softkey menus and features mentioned in this guide are only available through the Web-Enabled MXG or through SCPI commands. For information on the Web-Enabled MXG, refer to the *Installation Guide*, the *Programming Guide*, and to the *SCPI Command Reference*.

---

Before using this information, you should be familiar with the basic operation of the signal generator. If you are not comfortable with functions such as setting the power level and frequency, refer to [Chapter 3, “Basic Operation,” on page 41](#) and familiarize yourself with the information in that chapter.

- [Using the Dual Power Meter Display on page 80](#)
- [Using Flatness Correction on page 88](#)
- [Using Internal Channel Correction—\(Requires Option U01 or Greater\) on page 97](#)
- [Using External Leveling \(N5183A Only\) on page 102](#)
- [Using Unleveled Operating Modes on page 110](#)
- [Using an Output Offset, Reference, or Multiplier on page 113](#)
- [Using Free Run, Step Dwell, and Timer Trigger on page 117](#)
- [Using LXI \(Option ALB\) on page 120](#)
- [Using a USB Keyboard on page 126](#)

## Using the Dual Power Meter Display

The dual power meter display can be used to display the current frequency and power of either one or two power sensors. The display outputs the current frequency and power measured by the power sensors in the larger center display and in the upper right corner of the display. Refer to [Figure 5-2](#), [Figure 5-2](#), and [Figure 5-3](#).

**NOTE** The dual power meter display feature is only available on instruments with serial prefixes  $\geq$ US/MY/SG4818.

To use two U2000 USB Series power sensors with the MXG, a USB hub (with power supply), can be connected to the MXG's front panel USB connector.

**Figure 5-1** Dual Power Meter Display with Power Sensors A and B Calibrated

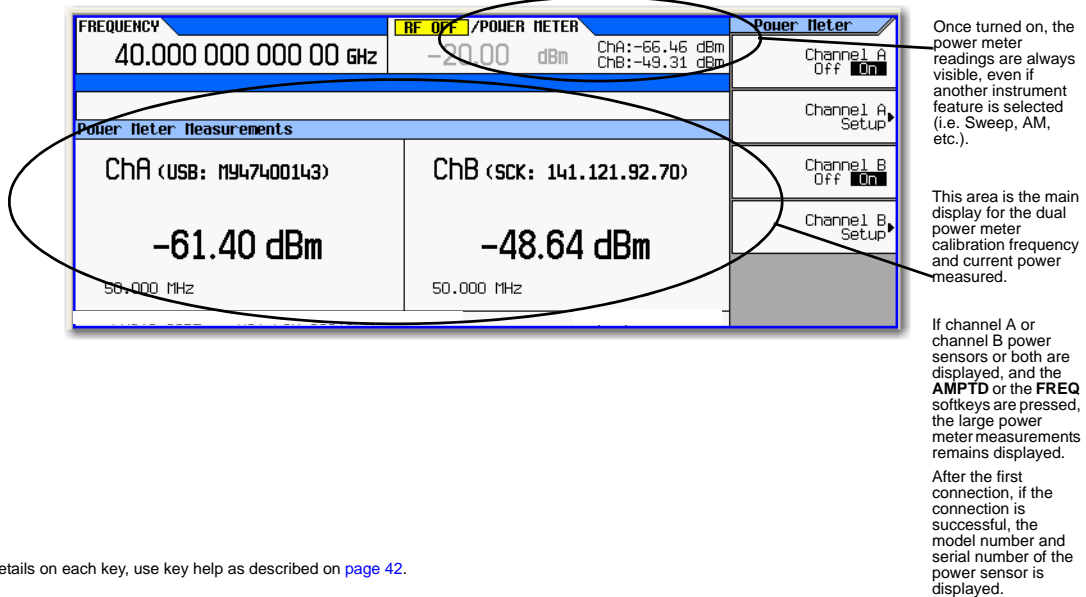

For details on each key, use key help as described on [page 42](#).

Figure 5-2 Dual Power Meter Display Menu

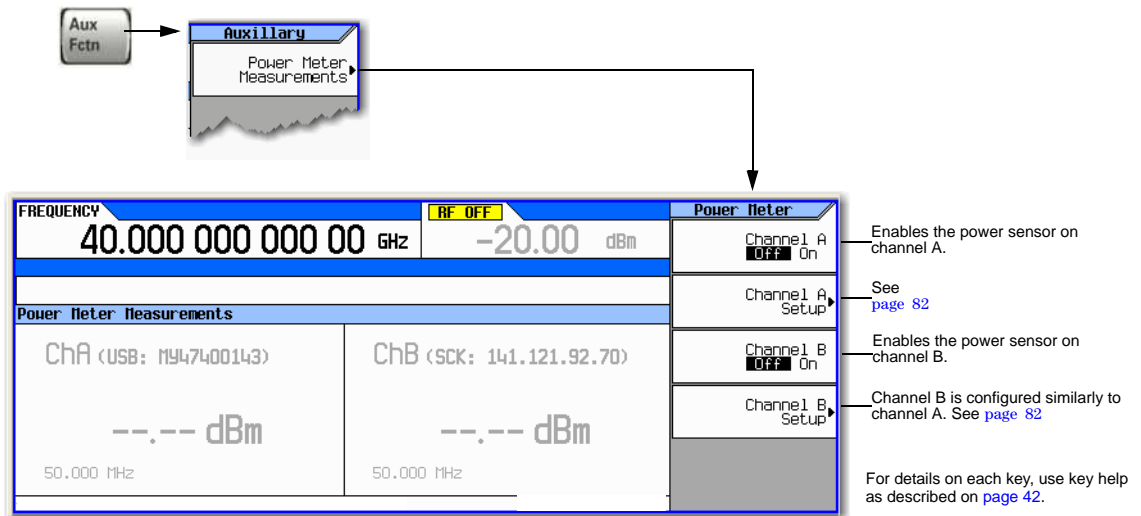
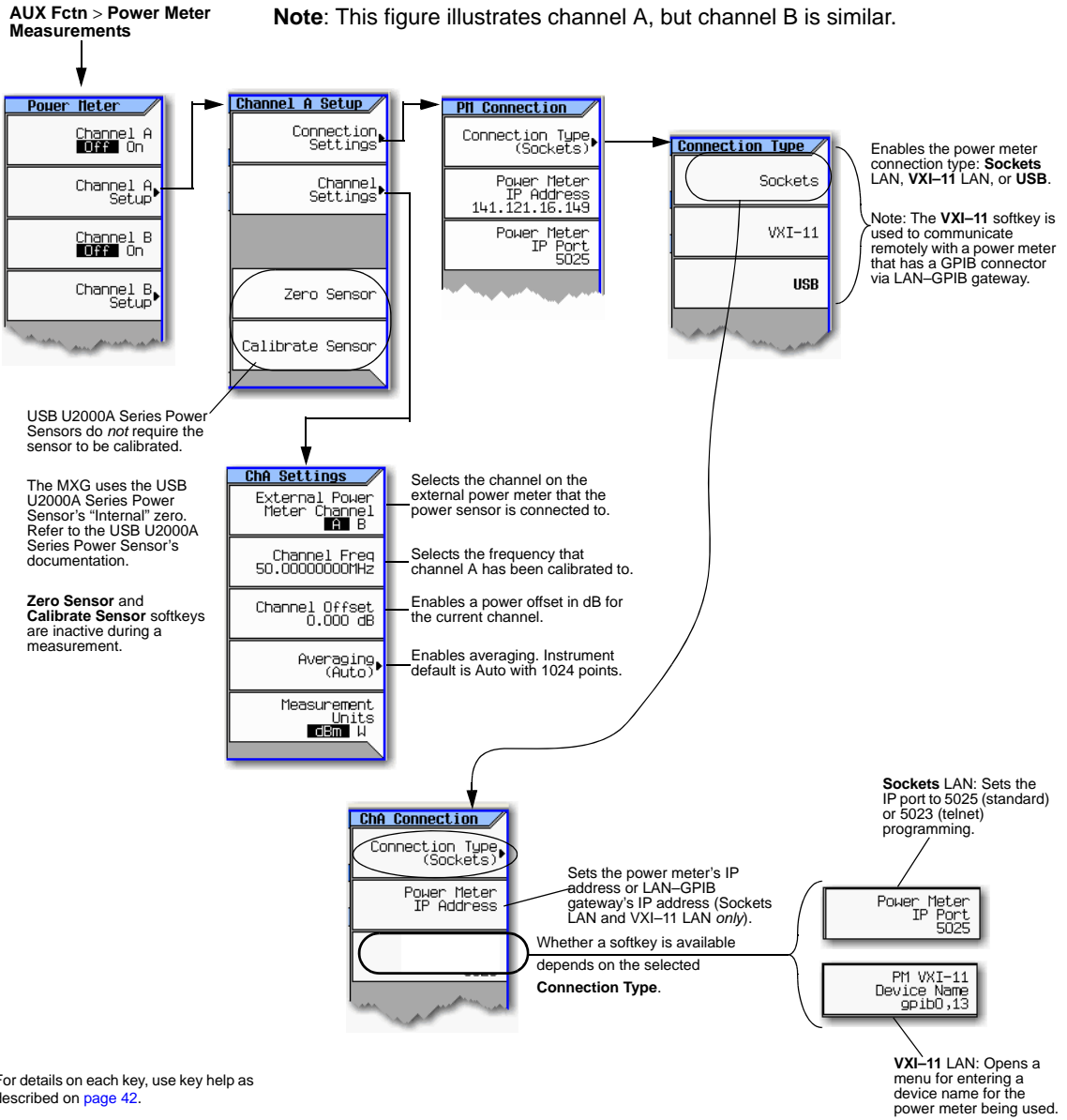

Figure 5-3 Configuring the Power Sensor Channels





## Example: Dual Power Meter Calibration

In the following example a U2004A USB Power Sensor is connected to channel A and a N1912A P-Series Power Meter and 8482A Power Sensor are connected to channel B and are zeroed and calibrated, as required.

On the MXG:

1. Setup MXG for Step Sweep. “Configuring a Swept Output” on page 48.

---

**CAUTION** Verify RF Output power is off before continuing.

---

2. Connecting the Channel A power sensor: Connect USB sensor to MXG. The MXG should display a message across the bottom that reads similar to:  
USB TMC488 device (USB POWER SENSOR,MY47400143) connected

Figure 5-4 MXG Displays Connection to U2000 USB Power Sensor

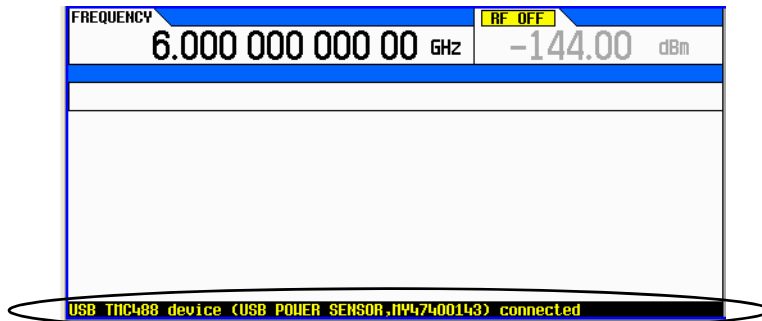

3. Press **Aux Fctn** > **Power Meter Measurements** > **Channel A Setup** > **Connection Settings** > **Connection Type** > **USB Device (None)** > USB POWER SENSOR (MY47400143)
4. Press **Return** > **Zero Sensor**

A diagnostic dialog box appears the *initial* time that a U2000 Series power sensor with a different serial number is connected to the MXG (refer to Figure 5-5). After the U2000 has been recognized by the MXG, the U2000 power sensor is saved as a softkey in the instrument and the dialog box in Figure 5-5 won't be displayed (press DONE, if you see this message).

Figure 5-5 Diagnostic Dialog Box for USB Sensor

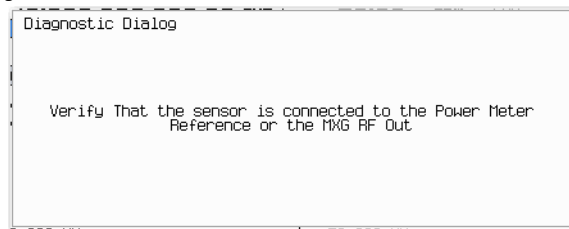

A Running Calibration(s) bar is displayed on the MXG. Refer to Figure 5-6 on page 84.

Figure 5-6 Running Calibration(s) Bar (Zeroing Sensor)

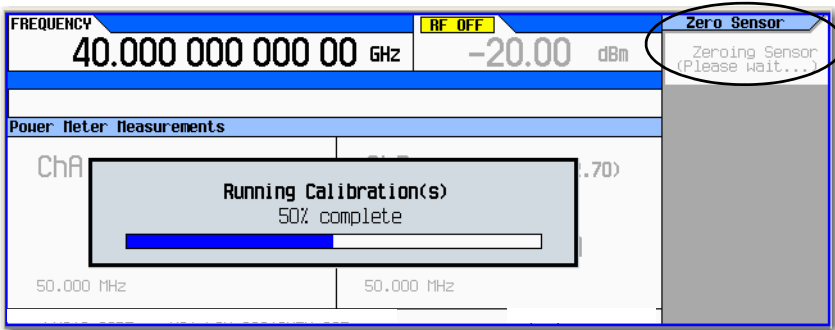

For details on each key, use key help as described on page 42.

**NOTE** The U2000 Series USB Power Sensor, does *not* require a 50 MHz calibration. If a calibration is attempted with the U2000 Series Power Sensors, the MXG displays a message reading:  
The U2000 series power sensor does not require a 50 MHz calibration. Refer to [Figure 5-7 on page 84](#).

Figure 5-7 Diagnostic Dialog Box Displayed for U2000 Power Sensor

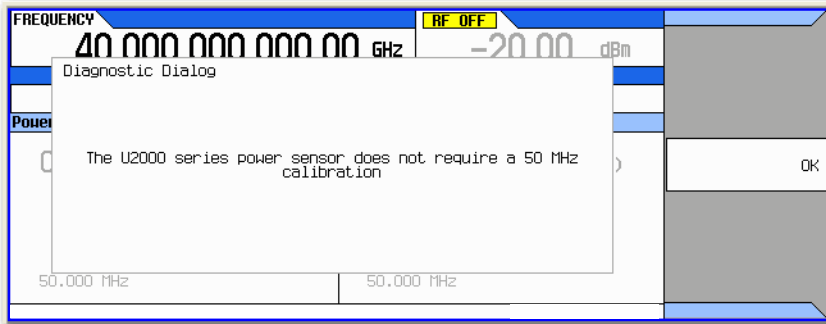

For details on each key, use key help as described on page 42.

5. Press **Return** > **Return** > **Channel A** to On

The current power meter sensor reading should be displayed in the ChA portion of the instrument's display and in the upper right portion of the display under Power Meter. Refer to [Figure 5-8](#).

Figure 5-8 Channel A Power Sensor Displayed on MXG

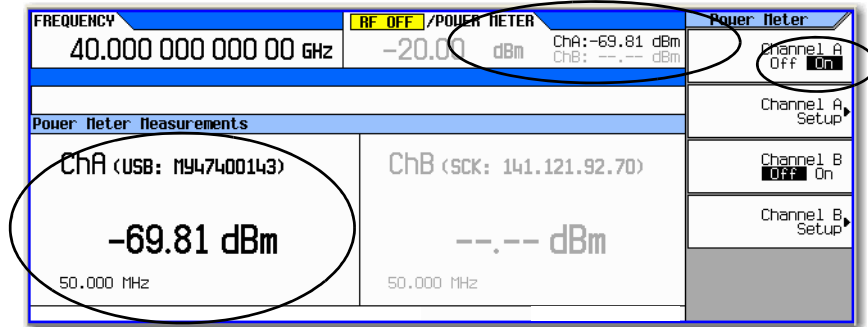

For details on each key, use key help as described on page 42.

6. On the N1912A P-Series Power Meter (*Channel B power sensor*): Connect the N1912A P-Series Power Meter to the LAN.
7. Connect the power meter sensor to channel B of the power meter.

**NOTE** It is recommended, but not required to use the channel B on the N1912A. This provides continuity with the MXG's dual display. For this example, the U2004A has already used up the channel A position on the MXG.

8. Connect the power sensor input to the 50 MHz reference of the power meter.
9. Press **Channel B Setup**
10. Press **Connection Settings > Sockets**
11. Press **IP Address > IP address > Enter**

**NOTE** The IP address of the power meter should be displayed in the ChB section of the display.

Figure 5-9 Channel B Power Sensor with IP Address Entered

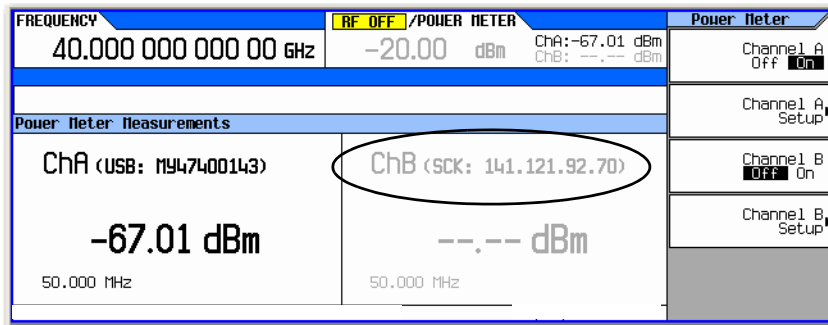

For details on each key, use key help as described on page 42.

12. Press **Return > Channel Settings > External Power Meter Channel** to B

13. On the MXG: Press Channel B to On and then back to Off again. This initializes the MXG to the external power meter.

14. Press **Return** > **Zero Sensor**

A diagnostic dialog box is displayed each time an external power meter is being used and the Zero Sensor or Calibrate Sensor softkey is pressed (refer to [Figure 5-10 on page 86](#)).

Verify the power sensor is connected to the 50 MHz reference of the power meter.

**Figure 5-10 Diagnostic Dialog Box for Channel B**

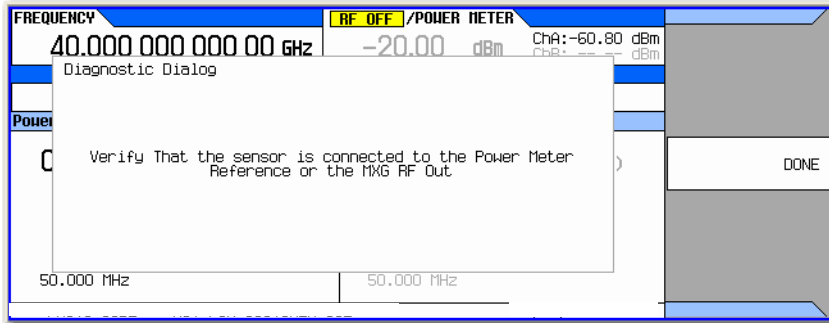

For details on each key, use key help as described on [page 42](#).

15. Press **Done**

The Running Calibration(s) bar is displayed: Zeroing Sensor Please wait....

16. After Running Calibration(s) bar disappears: Press **Calibrate Sensor**

Diagnostic Dialog box is displayed that prompts for verifying the connection of the power sensor to the power meter 50 MHz reference (refer to [Figure 5-11 on page 86](#)).

**Figure 5-11 Diagnostic Dialog Box for Calibration**



For details on each key, use key help as described on [page 42](#).

17. Press **Done**

Calibration progress bar is displayed. Refer to [Figure 5-12 on page 87](#).

**Figure 5-12 Running Calibration(s) Bar (Calibrating Sensor)**

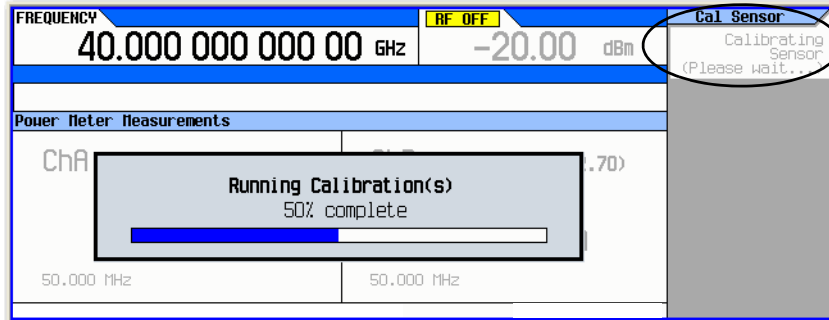

For details on each key, use key help as described on [page 42](#).

18. Press **Return** > **Channel B** to On

19. The current power meter sensor reading should be displayed on the MXG in the ChB portion of the display and in the upper right corner of the display under Power Meter and to the left of the Power Meter power sensor reading.

**Figure 5-13 Channel B Power Sensor Displayed on MXG**

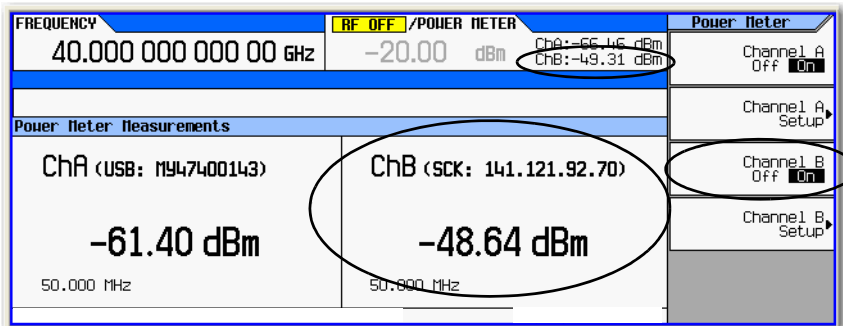

For details on each key, use key help as described on [page 42](#).

20. The power sensors are now ready to be connected in a measurement setup.

## Using Flatness Correction

User flatness correction allows the digital adjustment of RF output amplitude for up to 1601 sequential linearly or arbitrarily spaced frequency points to compensate for external losses in cables, switches, or other devices. Using an Agilent N1911A/12A, E4419A/B, or U2000 Series power meter/sensor to calibrate the measurement system, a table of power level corrections can automatically be created for frequencies where power level variations or losses occur. Supported connection types to the power meter/sensor are Sockets LAN, VXI-11 LAN, USB, and GPIB via VXI-11 LAN using a LAN-GPIB gateway (e.g. E5810A Gateway or equivalent).

---

**NOTE** A power meter with GPIB requires using the Connection Type **VXI-11** softkey, as well as a LAN-GPIB gateway, to control a power meter. Refer to the Agilent Connectivity Guide USB/LAN/GPIB Connectivity Guide (E2094-90009), Agilent MXG's FAQs "How do I connect to the LAN?", and to the E5810A User's Guide or equivalent, LAN/GPIB gateway device.

---

If you do not have an Agilent N1911A/12A or E4419A/B power meter, or U2000A/01A/02A/04A power sensor, or if your power meter does not have a LAN, GPIB, or USB interface, the correction values can be manually entered into the signal generator.

To allow different correction arrays for different test setups or different frequency ranges, you may save individual user flatness correction tables to the signal generator's memory catalog and recall them on demand.

Follow the steps in the next sections to create and apply user flatness correction to the signal generator's RF output (see [page 92](#)).

Afterward, follow the steps in "[Recalling and Applying a User Flatness Correction Array](#)" on [page 96](#) to recall a user flatness file from the memory catalog and apply it to the signal generator's RF output.

Figure 5-14 User Flatness Correction Softkeys

For details on each key, use key help as described on [page 42](#).

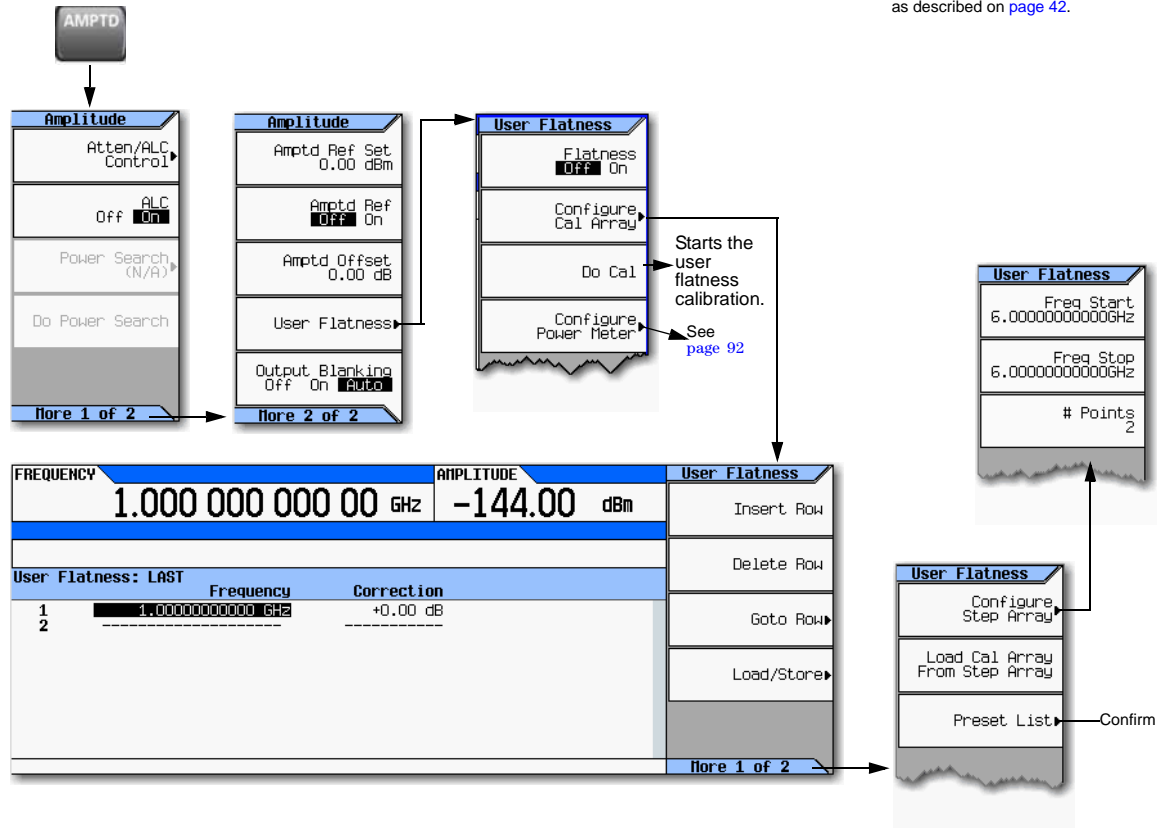

## Creating a User Flatness Correction Array

In this example, you will create a user flatness correction array. The flatness correction array contains ten frequency correction pairs (amplitude correction values for each specified frequency), from 500 MHz to 1 GHz.

An Agilent N1911A/12A or E4419A/B power meter and E4413A power sensor are used to measure the RF output amplitude at the specified correction frequencies and transfer the results to the signal generator. (A U2000 Series power meter/sensor could be used in lieu of the power meter and E4413A power sensor.) The signal generator reads the power level data from the power meter, calculates the correction values, and stores the correction pairs in the user flatness correction array.

If you do not have the required Agilent power meter, or if your power meter does not have a LAN, GPIB, or USB interface, you can enter correction values manually.

---

**NOTE** On the N5183A, if the setup is using an external leveling configuration, the equipment setup in [“Required Equipment” on page 90](#) assumes that the steps necessary to correctly level the RF output have been followed. If you have questions about external leveling, refer to [“Using External Leveling \(N5183A Only\)” on page 102](#).

---

### Required Equipment

- Agilent N1911A/12A or E4419A/B power meter (a power meter is *not* required with the U2000A/01A/02A/04A Power Sensor)
- Agilent E4413A E Series CW power sensor or U2000A/01A/02A/04A Power Sensor
- GPIB, LAN, or USB interface cables, as required
- adapters and cables, as required

---

**NOTE** For operating information on a particular power meter/sensor, refer to its operating guide.

---

### Connect the Equipment

Connect the equipment as shown in [“Connect the Equipment” on page 91](#).

---

**NOTE** During the process of creating the user flatness correction array, the power meter is remotely controlled by the signal generator.

---



## Connect the Equipment

- Agilent N1911A/12A or E4419A/B power meter<sup>a</sup>
- Agilent U2000A/01A/02A/04A power Sensor<sup>a</sup>
- LAN, GPIB, or USB interface cables, as required
- adapters and cables, as required

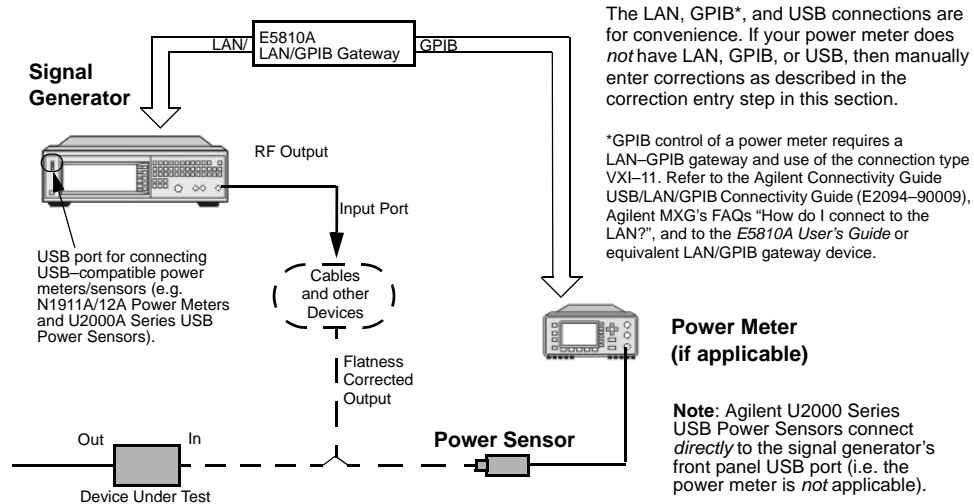

<sup>a</sup>For operating information, refer to the power meter/sensor documentation.

**Figure 5-15 Configure Power Meter Menu Softkeys**

AMPTD > More > User  
Flatness > Configure Power  
Meter

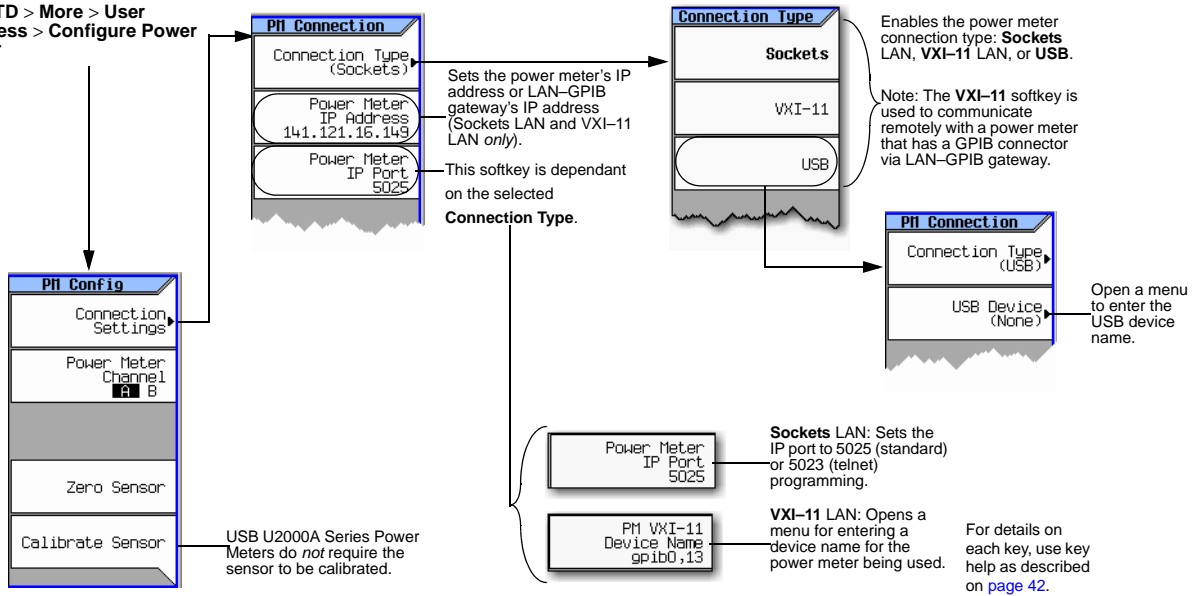

**Basic Procedure**

1. Create a user flatness array.
  - a. Configure the power meter/sensor
  - b. Connect the equipment
  - c. Configure the signal generator
  - d. Enter the user flatness correction values
2. Optionally, save the user flatness correction data.
3. Apply user flatness correction to the RF Output.

### Configure the U2000A/01A/02A/04A Power Sensor

1. Connect the power sensor to the signal generator's front panel USB port. Refer to [“Connect the Equipment” on page 91](#).
2. Zero the power sensor using the signal generator softkeys.

---

**CAUTION** Verify the signal generator RF Output power is set to the desired amplitude before performing the power meter zero. *No RF Output amplitude check is done by the signal generator during zero.*

---

**NOTE** The signal generator's RF Output LED remains unchanged during zeroing of the power sensor (e.g. if the RF Output LED was on prior to starting the Zeroing of the power sensor, the LED remains on throughout the zero/calibration). But, actually the instrument's firmware has turned *off* the RF Output's power.

For operating information on your particular power sensor, refer to its operation guide.

---

### Configure the E4419A/B and N1911A/12A Power Meter

1. Select SCPI as the remote language for the power meter.
2. Zero and calibrate the power sensor to the power meter, using the softkeys on the signal generator *or* the front panel of the power meter.
3. Enter the power sensor calibration factors into the power meter as required.
4. Enable the power meter's cal factor array.

---

**NOTE** The signal generator's RF Output LED remains unchanged during zeroing of the power sensor (e.g. if the RF Output LED was on prior to starting the Zeroing of the power sensor, the LED remains on throughout the zero/calibration). But, actually the instrument's firmware has turned *off* the RF Output's power.

For operating information on your particular power meter/sensor, refer to its operating guide.

---

### Example: A 500 MHz to 1 GHz Flatness Correction Array with 10 Correction Values

#### Create the User Flatness Array

1. Configure the signal generator:
  - a. Preset the signal generator.
  - b. Set the signal generator's connection type to the power meter/sensor:
    - i. Press **AMPTD** > **More** > **User Flatness** > **Configure Power Meter** > **Connection Type** > *connection type*.
    - ii. If connection type is USB:
      1. Zero Sensor
      2. Go to step **c**.

*else*

If Sockets LAN or VXI-11 LAN: Press **Power Meter IP Address** > *power meter's or LAN-GPIB gateway IP address* > **Enter**.

- iii. If Sockets LAN: Press **Power Meter IP Port** > *IP port* > **Enter**.

*else*

If VXI-11: Press **PM VXI-11 Device Name** > *device name* > **Enter**.

When connecting directly to the power meter, enter the *device name* as specified in the power meter's documentation. Typically, this is "inst0" and is case sensitive for some power meters. Refer to your power meter's documentation, the Agilent Connectivity Guide USB/LAN/GPIB Connectivity Guide (E2094-90009), and Agilent MXG's FAQs "How do I connect to the LAN?"

When connecting via a LAN-GPIB gateway, enter the SICL address of the power meter. Typically, this is "gpib0,13", where "gpib0" is the GPIB SICL interface name of the gateway and "13" is the GPIB address of the power meter. Refer to the Agilent Connectivity Guide USB/LAN/GPIB Connectivity Guide (E2094-90009), Agilent MXG's FAQs "How do I connect to the LAN?", and to the E5810A User's Guide or equivalent, LAN/GPIB gateway device.

- c. Open the User Flatness table editor and preset the cal array:  
Press **Return** > **Configure Cal Array** > **More** > **Preset List** > **Confirm Preset with Defaults**.
- d. In the Step Array menu, enter the desired flatness-corrected start and stop frequencies, and the number of points:

Press **More** > **Configure Step Array** >

**Freq Start** > **500** > **MHz** >

**Freq Stop** > **1** > **GHz** >

**# of Points** > **10** > **Enter**

- e. Populate the user flatness correction array with the step array configured in the previous step:

Press **Return** > **Load Cal Array From Step Array** > **Confirm Load From Step Data**.

- f. Set the output amplitude to 0 dBm.
- g. Turn on the RF output.

2. Connect the power meter to the RF output and enter the correction values:

With a Power Meter Over LAN, GPIB, or USB	Manually
<p>i. Create the correction values: Press <b>More &gt; User Flatness &gt; Do Cal.</b></p> <p>The signal generator begins the user flatness calibration, and displays a progress bar.</p> <p>The amplitude correction values load automatically into the user flatness correction array.</p> <p>ii. View the stored amplitude correction values: Press <b>Configure Cal Array.</b></p>	<p>i. Open the User Flatness table editor and highlight the frequency value in row 1: Press <b>More &gt; User Flatness &gt; Configure Cal Array.</b></p> <p>The RF output changes to the frequency value of the table row containing the cursor.</p> <p>ii. Note the value measured by the power meter.</p> <p>iii. Change the sign on the delta value (e.g. <i>the delta value of the 0 dBm reference value (step f), and the measured value from ii is -.34, change the value to +.34</i>).</p> <p>iv. Highlight the correction value in row 1.</p> <p>v. Press <b>Select &gt; enter the delta calculated in step iii &gt; dB.</b> (e.g. For this example enter +.34)</p> <p>The signal generator adjusts the output amplitude based on the correction value entered.</p> <p>vi. Repeat steps ii – v until the power meter reads 0 dBm.</p> <p>vii. Highlight the frequency value in the next row.</p> <p>viii. Repeat steps ii through vii for the remaining rows.</p>

The user flatness correction array title displays User Flatness: (UNSTORED), without a name, indicating that the current user flatness correction array data has *not* been saved to the file catalog.

**Optional: Save the User Flatness Correction Data**

1. Press **Load/Store > Store to File.**

2. Enter a file name (for this example, FLATCAL1) and press **Enter.**

The user flatness correction array file is now stored in the file catalog as a USERFLAT file. Any user flatness correction files saved to the catalog can be recalled, loaded into the correction array, and applied to the RF output to satisfy specific RF output flatness requirements.

3. Press **Return.**

**Enable the Flatness Correction at the RF Output**

- Press **Return > Flatness Off On.**

The UF annunciator appears in the AMPLITUDE area of the display, and the correction data in the array is applied to the RF output.

## Recalling and Applying a User Flatness Correction Array

The following example assumes that a user flatness correction array has been created and stored. If not, perform the [Example: A 500 MHz to 1 GHz Flatness Correction Array with 10 Correction Values](#) on page 93.

1. Preset the signal generator.
2. Recall the desired User Flatness Correction file:
  - a. Press **AMPTD > More > User Flatness > Configure Cal Array > More > Preset List > Confirm Preset.**
  - b. Press **More > Load/Store.**
  - c. Highlight the desired file.
  - d. Populate the user flatness correction array with the data contained in the selected file:  
Press **Load From Selected File > Confirm Load From File.**  
The user flatness correction array title displays User Flatness: *Name of File.*
3. Apply the correction data in the array to the RF output: Press **Return > Flatness Off On** to **On.**

## Using Internal Channel Correction—(Requires Option U01 or Greater)

The internal channel correction feature corrects the 100 MHz baseband bandwidth flatness and phase for arbitrary center frequencies. This feature is off by default, as the switching speed performance of the instrument is impacted when this feature is on.

This calibration should be run when the ambient temperature has varied by at least  $\pm 5$  degrees Celsius from the ambient temperature at which the previous calibration was run.

---

**NOTE** There is an internal calibration routine that can be run to collect correction data for both the baseband and RF magnitude and phase errors over the entire RF frequency range on any unit with options 651, 652, or 654. The internal channel correction cannot be turned on until after the correction has been executed once.

For new instruments, shipped with firmware version A.01.60 and above, the internal flatness correction calibration has already been run.

---

When this feature is off, the box will behave as it always has. When this feature is on, the internal I/Q path is active, the I/Q Correction Optimized Path is RF Output, and the frequency is changed by more than 1 kHz, the firmware will calculate a channel correction filter  $\pm 50$  MHz about the specified frequency. For List/Sweep, the calculation will be done prior to the first sweep using the specified frequencies when either waveform sweep is active or the baseband is on and the instrument is optimized for the internal path. This calculation will cache corrections for up to the maximum number of cache points (256). For list/sweep, the sweep will pause and recalculate the correction caches before running again.

---

**CAUTION** In the case of arbitrary frequency switching, once the correction cache is full (256 unique frequency points), the oldest frequency corrections will be forgotten as new frequencies are selected.

Whenever I/Q Timing Skew, I/Q Delay, Quadrature Angle Adjustment, or the Int Equalization Filter is adjusted, all caches are forgotten.

---

Additional characteristics of the internal channel correction:

- When the internal channel correction is on, arbitrary frequency switching while the baseband is on will take up to an additional 290 ms (72 ms typical) the first time that frequency is specified. After the first time that a frequency is selected, switching to that frequency again takes an additional 1 ms.
- If a frequency sweep is activated, then the calculation and caching will occur up front for the first 256 unique frequencies, and all additional unique frequencies will have the characteristics of arbitrary frequency switching.
- If the I/Q Correction Optimized Path softkey is set to Ext I/Q, then only the baseband corrections will be applied and the frequency switching will be unaffected.
- If active, the ACP Internal I/Q Channel Optimization filter and the Equalization filter, will be convolved with the internal channel correction. A hamming window is applied and the resulting filter will be truncated to 256 taps.

Figure 5-16 Internal Channel Correction Softkeys

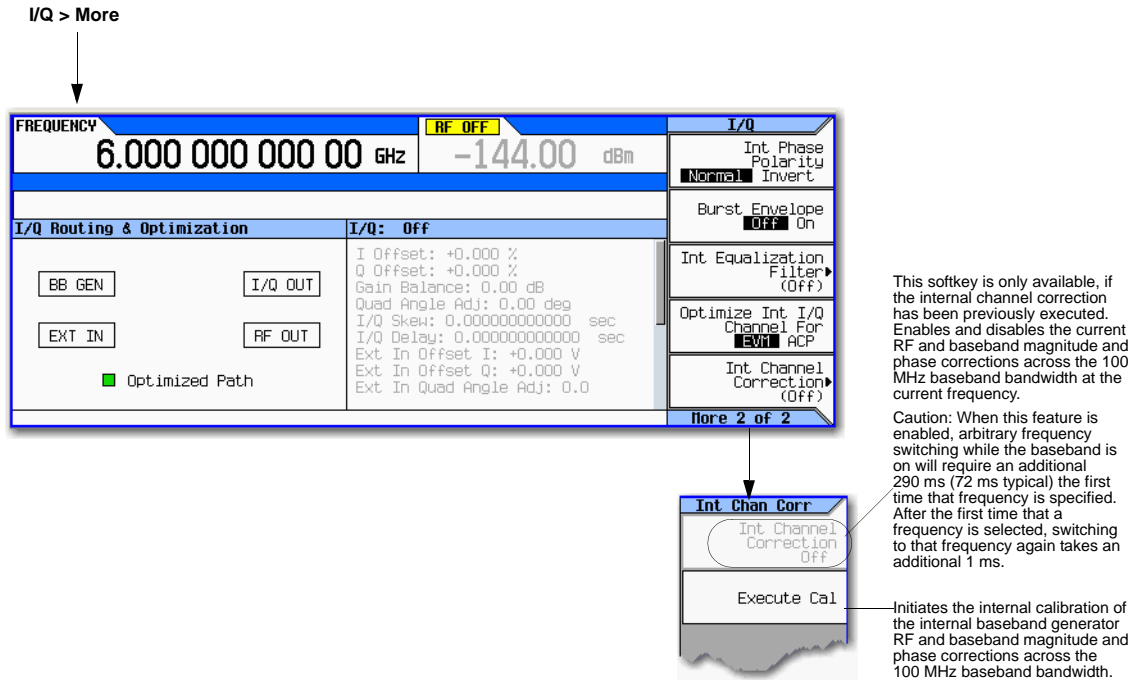

SCPI Commands:

```
[ :SOURCE ] :DM:INTernal:CHANnel:CORRection[:STATE] ON|OFF|1|0
[ :SOURCE ] :DM:INTernal:CHANnel:CORRection[:STATE]?
:CALibration:BBG:CHANnel
```

For details on each key, use key help as described on [page 42](#).

## Configure Internal Channel Correction

The following is a basic configuration for using the MXG’s internal channel correction. Refer to [Figure 5-16](#).

On the MXG:

1. Set the center frequency:

Press **Freq > 3 > GHz**

2. Set the I/Q to internal (default):

Press **I/Q > I/Q Source > Internal**

3. Press **I/Q** to On

4. Perform internal channel correction:

Press **More > Int Channel Correction > Execute Cal**

5. Press **Int Channel Correction to On**



## Using I/Q Mod Skew Cal

The I/Q mod skew calibration initiates the external calibration of the I/Q timing skew for the I/Q modulator (RF output path). This feature will improve out-of-channel image rejection.

This calibration requires the RF output of the instrument to be connected to the RF input of a spectrum analyzer.

---

**NOTE** This calibration needs to be run only once for any set of hardware.

For instruments that shipped with firmware release A.01.60 or newer, this calibration does not need to be run unless hardware inside of the instrument is repaired or replaced.

For instruments that shipped prior to the release of A.01.60 firmware, option "R2C: Core FW enhancements, A.01.60" or newer must be purchased to allow the full Int Channel Correction functionality, which corrects the internal baseband generator RF and baseband magnitude and phase across the 100MHz baseband bandwidth for all RF frequencies.

For instruments that shipped prior to firmware release A.01.60 that have had option "R2C: Core FW enhancements, A.01.60" or newer installed, the Int Channel Correction feature will achieve its full correction only after this calibration has been run once.

---

**Figure 5-17 I/Q Mod Skew Cal Softkeys**

I/Q > More > Int Channel Correction (Option U01)  
or  
I/Q > More > I/Q Mod Skew Cal

FREQUENCY	CHANCORR	RF OFF	Int Chan Corr
6.000 000 000 00 GHz		-144.00 dBm	Int Channel Correction Off <b>On</b>
ERR			Execute Int Chan Corr Cal
<b>I/Q Int Channel Corrections And I/Q Mod Skew</b>			
Int Chan Corr Cal: Applied			
I/Q Mod Skew Cal: Always applied if optimized path is RF Output			
Calibration Instructions: 1) Execute Full I/Q Calibration 2) Execute Int Chan Corr Cal			Configure Spectrum Analyzer
I/Q Mod Skew Cal does not need to be run			Execute I/Q Mod Skew Cal
*** DEMO CODE ***			09/23/2009 13:34

The status window shows the current state of the calibrations, and instructions on how to run the calibrations.

See Figure 5-18 for information on this key.

Initiates the external calibration of the I/Q Timing Skew for the I/Q Modulator (RF output path) using the spectrum analyzer configured in the Configure Spectrum Analyzer key.

SCPI Command:

:CALibration:BBG:SKEW:RFOut

For details on each key, use key help as described on page 42.

Figure 5-18 SA Config Softkeys

I/Q > More > Int Channel Correction > Int Chan Corr

The screenshot shows the SA Config menu with the following fields and options:

- FREQUENCY:** 6.000 000 000 00 GHz
- RF OFF:** -144.00 dBm
- SA Config:**
  - Connection Type (VXI-11)
  - Spectrum Analyzer IP Address: 141.121.149.43
  - SA VXI-11 Device Name: Inst0
  - Test Connection

Callouts from the right side of the image:

- Points to the **Connection Type** menu: Sets the spectrum analyzer connection type to Sockets (LAN).
- Points to the **Sockets** option: Sets the spectrum analyzer connection type to VXI-11 (LAN). This connection type can also be used to connect to a GPIB spectrum analyzer via a LAN-to-GPIB gateway.
- Points to the **Test Connection** button: Attempts to connect to the specified external spectrum analyzer and execute a "\*IDN?" SCPI command. If the result is "Connected, but no \*IDN?" response", then the IP address connected to something, but the socket port or VXI-11 device name was not correct. Recognized Spectrum Analyzer models are currently: E4440A, E4443A, E4445A, E4446A, E4448A, and N9020A.

Callout from the bottom of the screenshot:

The status window shows the connection status of the spectrum analyzer.

SCPI Commands:

```
:SYSTem:SANalyzer:COMMunicate:TYPE SOCKets|VXI11
:SYSTem:SANalyzer:COMMunicate:LAN:DEVIce <"deviceName">
:SYSTem:SANalyzer:COMMunicate:LAN:DEVIce?
:SYSTem:SANalyzer:COMMunicate:LAN:IP <"ipAddr">
:SYSTem:SANalyzer:COMMunicate:LAN:IP?
:SYSTem:SANalyzer:COMMunicate:LAN:PORT <portNum>
:SYSTem:SANalyzer:COMMunicate:LAN:PORT?
:SYSTem:SANalyzer:COMMunicate:TYPE SOCKets|VXI11
:SYSTem:SANalyzer:COMMunicate:TYPE?
```

For details on each key, use key help as described on [page 42](#).

## Using External Leveling (N5183A Only)

**CAUTION** While operating in external leveling mode, if either the RF or the DC connection between the signal generator and the detector is broken, maximum signal generator power can occur. This maximum power may overstress a power-sensitive device under test.

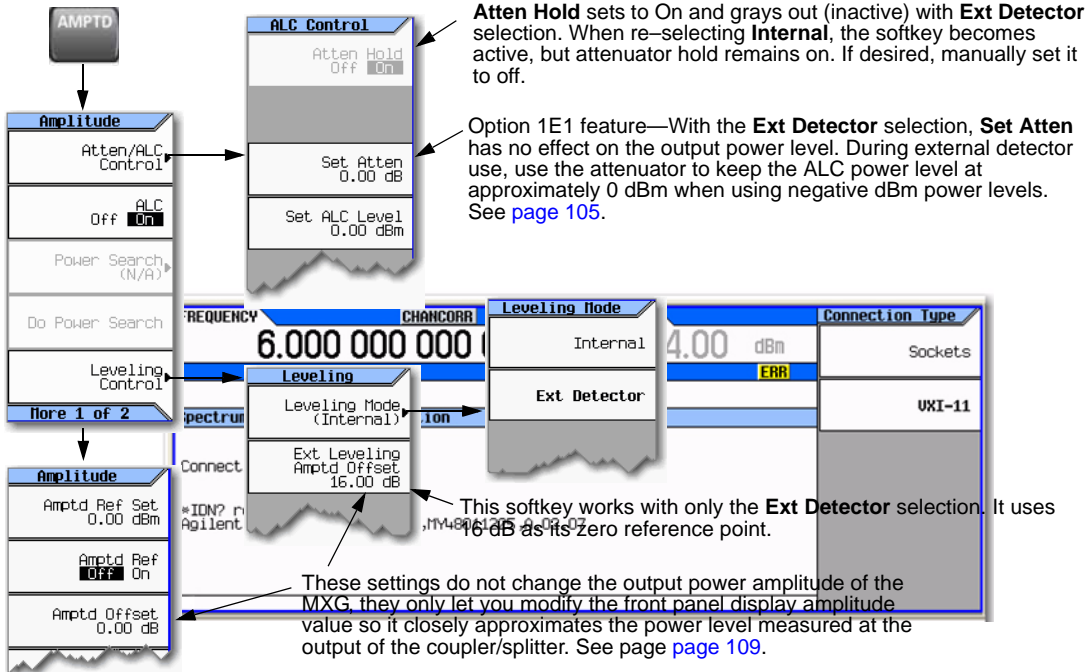

External leveling lets you move the ALC feedback source closer to the device under test (DUT) so that it accounts for most of the power uncertainties inherent to the cabling and components in a test setup. Refer to [Figure 5-19](#).

Figure 5-19 ALC Circuitry

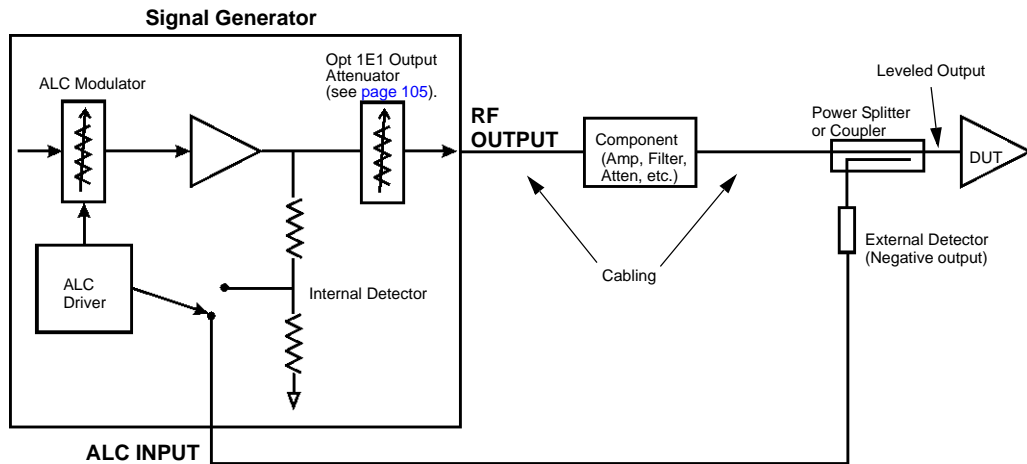

The external detector outputs a negative voltage to the signal generator's rear panel ALC INPUT connector based on the power level at the detector. As the RF power level at the coupler's/power splitter input changes, the external detector returns a compensating negative voltage. The ALC circuit uses this negative voltage to level the RF output power by raising and lowering the signal's power, thus ensuring a constant power level at the point of detection (external detector). Since the point of detection does not occur at the output of the device to which the detector is connected, there is some power loss that is not compensated for by the external detector. For example on a coupler, the coupled port siphons some of the signal's energy to drive the external detector. In addition the coupler experiences some insertion loss between the coupled port and the output.

Figure 5-21 on page 105 shows the input power versus output voltage characteristics for typical Agilent Technologies diode detectors. Using this chart, you can determine the leveled power at the diode detector input by measuring the external detector output voltage. For a coupler, you must then add the coupling factor to determine the leveled output power.

When using an external detector, the signal generator's power range may vary from the values shown in the data sheet. This is primarily due to the efficiency of the detector. Always ensure that the detector, coupler/power splitter are specified for the power and frequency range of interest. To determine the signal generator's actual power range during external leveling, see "Determining the Signal Generator's Amplitude Range" on page 107.

With external leveling, the displayed amplitude value can vary significantly from the actual output power of the coupler/power splitter to which the external detector is connected (see Figure 5-20). This is because the coupler/power splitter has its own signal characteristics (insertion loss, coupling factor, and so forth), which are unknown to the signal generator, so it is typically unable to display an accurate amplitude value. Also components between the signal generator and the external detector can affect the output power of the coupler/power splitter. You can compensate for this power display difference by using the

**Ext Leveling Amptd Offset** softkey or the **Amptd Offset** softkey. The difference between the two softkeys is that the **Ext Leveling Amptd Offset** functions only while external leveling is active. For more information on using the external leveling offset feature, see "Adjusting the Signal Generator Display's Amplitude Value" on page 109.

Figure 5-20 Power Value Differences with External Leveling

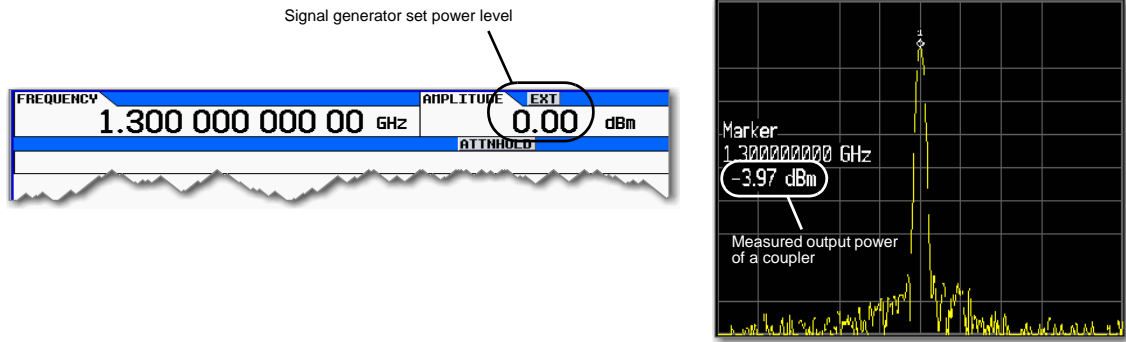
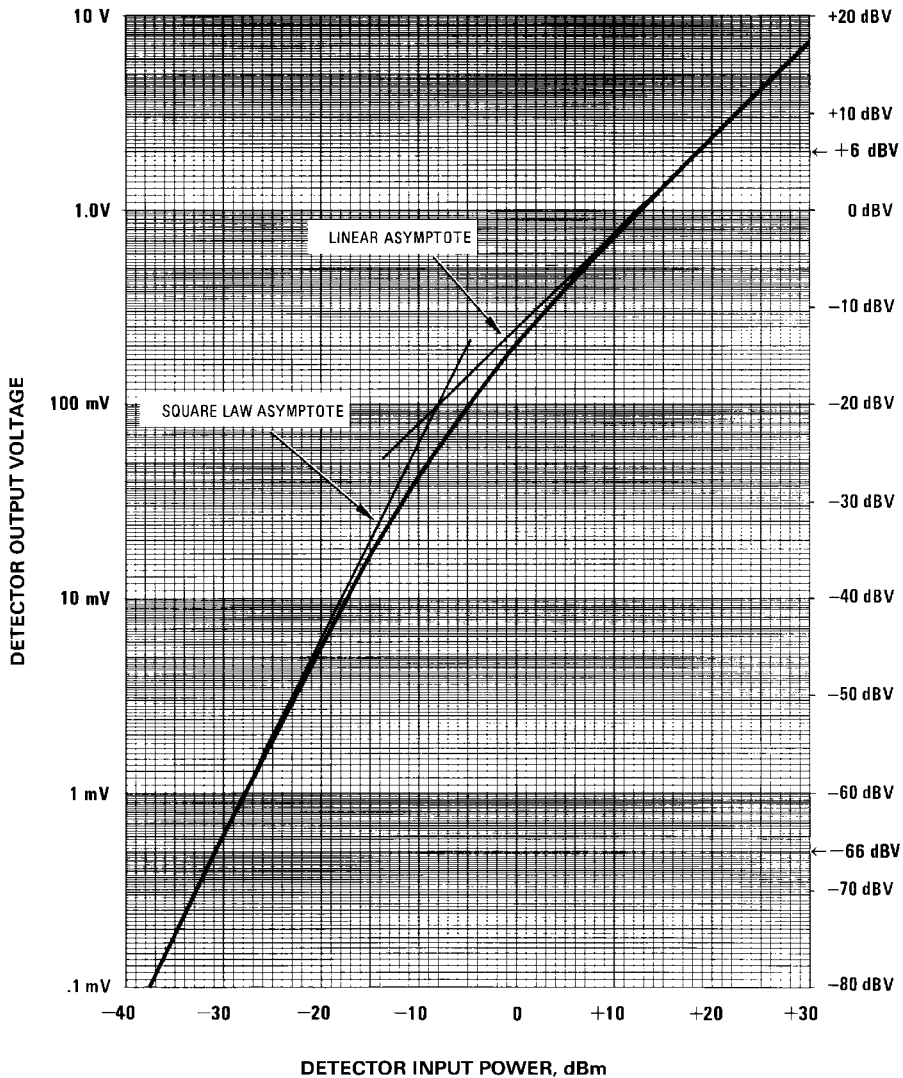

Figure 5-21 Typical Diode Detector Response at 25° C



### Option 1E1 Output Attenuator Behavior and Use

When using the internal detector, the Option 1E1 output attenuator enables signal generator power levels down to -135 dBm at the RF Output connector. It accomplishes this by adding attenuation to the output signal after the ALC detection circuit. The output power value (shown in the Amplitude area of the display) is the resultant of the **Set Atten** and **Set ALC Level** values (see [page 102](#)). With the external detector selected, the output attenuator no longer attenuates the output signal since the

feedback for the detection circuit has been moved beyond the output attenuator. Because the attenuator no longer affects the amplitude of the output signal, the output amplitude is determined by only the **Set ALC Level** softkey.

With external leveling selected, the signal generator enables attenuator hold and the power range approximates the range of a standard option (no attenuator) signal generator (see the *Data Sheet*). As stated earlier, the actual output power may vary due to the external detector and the coupler/power splitter performance characteristics.

---

**NOTE** When the internal detector (**Internal** selection) is reselected, the signal generator does not turn the attenuator hold off.

---

Even though the output attenuator no longer affects the output power, it is still useful to drive the ALC circuit to its mid-power point of approximately 0 dBm, which is optimal for the internal leveling circuitry and typically provides the best amplitude flatness results. This is useful with negative power values of -5 dBm or less. For example, to drive the ALC to approximately mid-power with a -20 dBm power setting, add 25 dB of attenuation. This sets the ALC circuit to 5 dBm (-20 + 25).

---

**NOTE** If there is too much attenuation, it will drive the ALC circuit too high and cause the signal generator to go unlevelled. Ensure that you decrease the attenuation as you increase the power level.

---

## Configure External Leveling

### Basic Setup Process

- If working with a single frequency signal, perform Steps 1 through 5.
  - If working with multiple frequencies:
    - a. Perform Steps 1 through 4.
    - b. Perform a user flatness correction, see [“Using Flatness Correction” on page 88](#).
  - If working with a sweep:
    - a. Perform Steps 1 through 4.
    - b. Setup the sweep, see [“Configuring a Swept Output” on page 48](#).
1. Setup the equipment, see [“Equipment Setup” on page 106](#)
  2. Configure the carrier signal, see [“Configuring the Carrier” on page 107](#)
  3. Select external leveling, see [“Selecting External Leveling” on page 107](#).
  4. Determine the output amplitude range, see [“Determining the Signal Generator’s Amplitude Range” on page 107](#)
  5. Set the displayed power value, see [“Adjusting the Signal Generator Display’s Amplitude Value” on page 109](#)

### Equipment Setup

Set up the equipment as shown in [Figure 5-22 on page 107](#). Place the external detector (detector and coupler/power splitter) as close as possible to the DUT.



### Recommended Equipment

- Agilent 8474E negative detector
- Agilent 87301D directional coupler
- cables and adapters, as required

Figure 5-22 Typical External Leveling Setup using a Directional Coupler

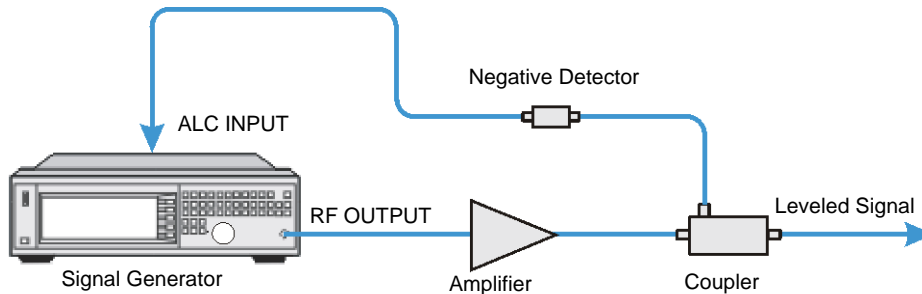

### Configuring the Carrier

1. Press **Preset**.
2. Set the carrier frequency.
3. Set the power level to 0 dBm:
  - If the signal generator has no output attenuator (no Option 1E1) or it has Options 1E1 and 532 or 540 installed:  
Press **AMPTD > 0 > dBm**.
  - If the signal generator has Options 1E1 and 520, set the output attenuator to zero dBm:
    - a. Press **AMPTD > Atten/ALC Control > Atten Hold Off On** to On.
    - b. Press **Set Atten > 0 > dB**.
    - c. Press **Set ALC Level > 0 > dBm**.

### Selecting External Leveling

Press **AMPTD > Leveling Control > Leveling Mode > Ext Detector**.

### Determining the Signal Generator's Amplitude Range

The maximum output amplitude is frequency dependent. So if you are using multiple frequency points and there is a need to know the maximum output amplitude for each frequency point, refer to the "Amplitude" section of the *MXG Data Sheet*. Then use this procedure to determine the maximum amplitude for each band.

With external leveling and Option 1E1, the signal generator's the power range approximates that of a standard option instrument (no Option 1E1). But Option 1E1 does let you use the attenuator to drive the ALC to its mid-power point when using negative amplitude values. However adding attenuation does decrease the upper range limit. For more information, see [“Option 1E1 Output Attenuator Behavior and Use” on page 105](#).

1. If Option 1E1 is installed, adjust the attenuator to the desired level.

---

**NOTE** If the Option 1E1 output attenuator value is too high (approximately  $\geq 55$  dB), it will cause an unlevel condition to occur when the RF output is turned on.

---

- a. Press **AMPTD > Atten/ALC Control > Set Atten.**
  - b. Enter the attenuator value.
2. Turn on the RF output: Press **RF On/Off** to On
  3. Set the **AMPTD** step increment value to one dB.
    - Press **AMPTD > Incr Set > 1 > dB.**
  4. Determine the minimum amplitude value:
    - a. Set the amplitude to  $-25$  dBm.
    - b. Using the down arrow key, decrease the amplitude until the UNLEVEL annunciator appears.
    - c. Using the up arrow key, increase the amplitude until the UNLEVEL annunciator is gone.  
The value showing when the UNLEVEL annunciator is gone is the minimum amplitude range value.
  5. Determine the maximum amplitude value:
    - a. Set the amplitude to a value that does not cause the signal generator to go unlevelled.
    - b. Using the up arrow key, increase the amplitude until it goes unlevelled or an error message indicating that the upper limit has been reached shows at the bottom of the display.
    - c. Decrease the amplitude value:
      - If the unlevelled annunciator appeared, decrease the amplitude until the annunciator is gone. The value where the annunciator disappears is the maximum upper range value.
      - If the signal generator displays Error: 501, Attenuator hold setting over range at the bottom of the display, the value showing is the maximum upper range value.  
To remove the error message, press the down arrow key until the message is gone. The error appears when an attempt is made to increase the amplitude beyond the maximum value as it relates to the current attenuator setting.

### Adjusting the Signal Generator Display's Amplitude Value

When using external leveling, the signal generator's displayed amplitude value will not match the leveled power of the signal at the output of the coupler/splitter. To compensate for this difference, the signal generator provides two methods for configuring the displayed power value so that it closely matches the measured value at the output of the coupler/splitter.

1. Connect and configure a measurement instrument:
  - a. Connect the output of the coupler/splitter to either a power meter or a signal analyzer.
  - b. Configure the power meter/signal analyzer for measuring the power level of the signal.
2. Adjust the signal generator's displayed amplitude value:
  - If using the **Ext Leveling Amptd Offset** Softkey:

This softkey uses 16 dB as its zero reference. The 16dB is the coupling factor of the internal detector.

    - a. On the signal generator, press **AMPTD > Leveling Control > Ext Leveling Amptd Offset**.
    - b. While viewing the carrier amplitude value on the signal generator display, use the RPG knob (detent knob) to adjust the offset value until the integer part of the displayed amplitude value is the same as the integer portion of the measured value.

Each detent position adjusts the value by 1 dB.
    - c. Using the number keypad, make the necessary fractional adjustments to the display amplitude value.
  - If using the **Amptd Offset Softkey**:
    - a. On the signal generator, press **AMPTD > Leveling Control > More > Amptd Offset**.
    - b. Calculate the difference between the signal generators displayed Amplitude value and the measured value.
    - c. Using the numeric keypad, enter this difference as the **Amptd Offset** softkey value.

## Using Unleveled Operating Modes

Figure 5-23 Power Search and ALC Off Softkeys

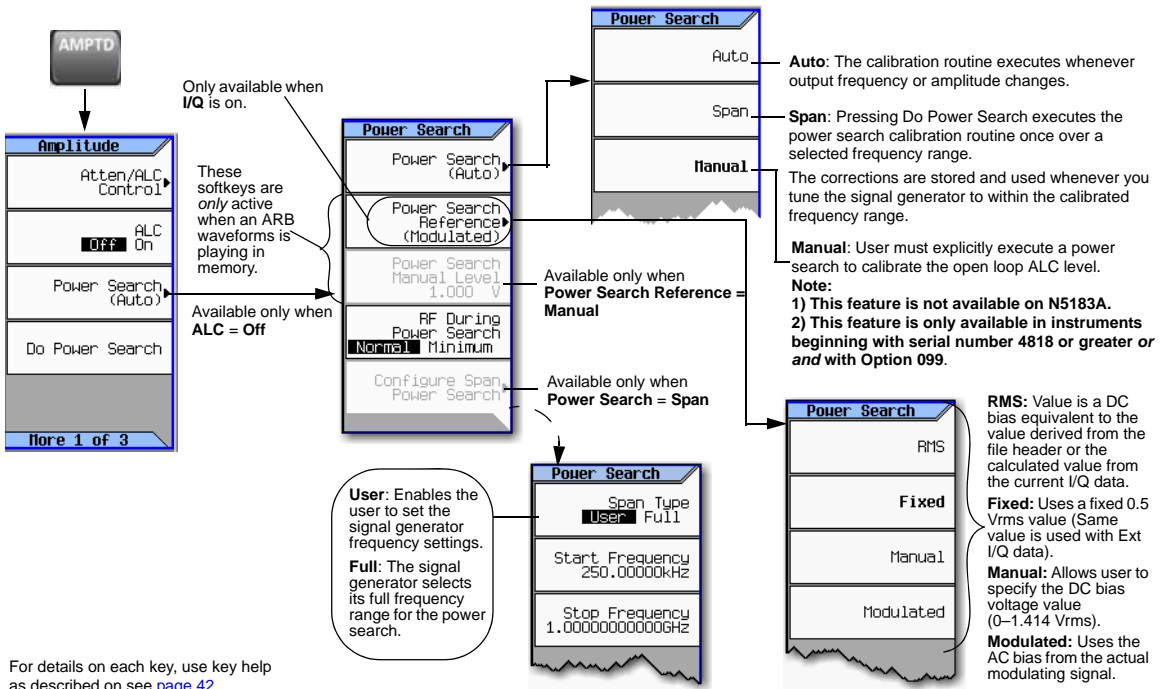

### ALC Off Mode

Turning ALC off deactivates the signal generator’s automatic leveling circuitry. Turning ALC off is useful when the modulation consists of very narrow pulses that are below the pulse width specification of the ALC or when up converting external IQ signals and the modulation consists of slow amplitude variations or bursts that the automatic leveling would remove or distort. When using the internal IQ baseband generator, the best technique is to use the ALC hold marker function vs. ALC off for the types of signals just described.

**NOTE** After the ALC has been turned off, power search must be executed to set the proper output power level requested on the front panel. Power search is executed automatically by default, but these settings can be overridden by using the Manual mode

## Power Search Mode

---

**NOTE** The power search mode cannot be used with bursted signals input via the external IQ inputs.

---

The MXG has three power search modes (for internal and external I/Q modulation) and four power search references (for external I/Q modulation only). Refer to [Figure 5-23 on page 110](#).

Power search executes a routine that temporarily activates the ALC, calibrates the power of the current RF output, and then disconnects the ALC circuitry.

### Power Search Modes (Applies to External and Internal I/Q Modulation)

- **Auto** – A power search is executed at each frequency or power change, and at each change to the AM, burst, pulse, or I/Q modulation state.
- **Span** – A power search is executed over a range of user-defined frequencies. The power search is stored and used when the MXG is tuned within a user-defined range. After the Span softkey is pressed, select either **Full** or **User**. If **User** is selected, then the start and stop frequencies need to be selected.
- **Manual** – When **Power Search** is set to Manual, pressing **Do Power Search** executes the power search calibration routine for the current RF frequency and amplitude. In this mode, if there is a change in RF frequency or amplitude, you will need to press **Do Power Search** again.

### Power Search References (Only applies to Internal I/Q Modulation)

The four Power Search References control the power search function. These four references select the reference voltage used while the RF signal is being I/Q modulated. (Power search references are not used for analog modulation: FM,  $\phi$ M, or pulse modulation.)

---

**CAUTION** If the power search reference has the incorrect RMS voltage, the output power will be incorrect. Refer to [Figure 5-24, "Calculating the Output Power Error for a Single Waveform Sample Point"](#) and [Figure 5-25, "Calculating the RMS Voltage of the Waveform."](#)

---



---

**NOTE** A successful power search is dependent on a valid power search reference.

---

- **Fixed** – Reference level is 0.5 Vrms.  
This reference functions with internal, external IQ and bursted signals. This is the instrument's default setting.
- **RMS** – User provided reference level 0–1.414 Vrms placed in the Waveform Header. Refer to ["Saving a Waveform's Settings & Parameters" on page 151](#).  
This reference functions with internal IQ and bursted signals.
- **Manual** – User provided reference level 0–1.414 Vrms.  
This reference functions with internal, external IQ and bursted signals.
- **Modulated** – Uses the I/Q modulation signal as the reference level.  
This reference functions with internal or external IQ. It is not functional with bursted signals or a signal with varying Vrms.

**Figure 5-24 Calculating the Output Power Error for a Single Waveform Sample Point**

$$\text{The Output Power Error} = 20 \times \log_{10}((V1)/(V2))$$

Where:

V1 is the actual waveform RMS voltage

V2 is the entered RMS voltage

Note: If the RMS voltage value entered is lower than the actual RMS voltage, the output power will be higher than desired. If the RMS voltage value entered is higher than the actual RMS voltage, the output power will be lower than desired.

**Figure 5-25 Calculating the RMS Voltage of the Waveform**

$$\text{RMS value for the waveform} = \sqrt{\sum_{n=1}^N (i_n^2 + q_n^2) \cdot \frac{1}{N}}$$

N = # of Samples

The MXG can calculate the RMS value automatically. If more than two contiguous IQ data points are zero, the MXG calculation ignores those zero points. Also, because the RMS calculation, that is done by the signal generator, is slow and may not be appropriate for your application, it is recommended that the user calculate and enter in their measured RMS value for the waveform file.

SCPI Commands:

```
[ :SOURCE ] :RADio:ARB:HEADER:RMS <"file_name">,<val>|UNSPecified
[ :SOURCE ] :RADio:ARB:HEADER:RMS? <"file_name">
```

For a programming example of determining the RMS voltage of a waveform, refer to the *Programming Guide* and to the *Documentation CD* that came with this instrument.

The RMS and MANUAL references are the most powerful selections. The user provides the reference level. The IQ signal can be bursted (radar) or have different RMS levels (Wireless Signals). Once the RMS/MANUAL reference level is set, the power search runs independent of the current Vrms value of the waveform.

The RMS and MANUAL references, with a reference level of 1.0 Vrms are equivalent to a calculated rms value of 1 and can be measured using SINE\_TEST\_WFM.

The FIXED, RMS, and MANUAL references use a DAC to apply the reference voltage and do not require the IQ signal to be present.

---

**NOTE** The MXG reference voltage is designed to operate between 0.1 Vrms to 1 Vrms nominally, but it can overrange to 1.414 Vrms. (The RMS can overrange to 1.414, if the constant values are loaded manually and all "1"s are entered for the I and Q values.) See also ["Saving a Waveform's Settings & Parameters"](#) on page 151.

---

**CAUTION** The minimum reference level that results in a successful power search is dependent on RF Frequency, RF Amplitude, and Temperature. An MXG power search using a reference level of 0.1 Vrms for 0 dBm at 1 GHz may fail.

---

## Power Search Settings

For the power search routine to execute, the instrument must be in the following conditions:

- The I/Q modulation enabled On.
- The RF output enabled On.
- The Automatic Leveling Circuitry deactivated (Off).
- The RF Blanking set to On.

This function prevents power spikes during the power search (refer to “Using the RF Blanking Marker Function” on page 168.)

- When using summing for the internal Arb and the external I/Q, all four power reference modes are available (e.g. Fixed, RMS, Manual, and Modulated).
- When using the external IQ inputs, use the MANUAL reference mode, and make sure the external I/Q signal is present when executing a power search. If the external I/Q signal is not present, the power search will fail.

### Example: Automatic Power Search

1. Preset the signal generator.
2. Set the desired frequency.
3. Set the desired amplitude.
4. Turn the RF output on.
5. Deactivate the signal generator’s automatic leveling control:

Press **AMPTD > ALC Off On** to highlight Off

Deactivating the signal generator’s automatic leveling control is a significant instrument change that automatically initiates a power search.

When set to Auto, power search automatically executes when a significant instrument setting changes. The Do Power Search feature enables you decide when to execute a power search to compensate for changes, such as temperature drift or a change in the external input.

## Using an Output Offset, Reference, or Multiplier

### Setting an Output Offset

Using an output offset, the signal generator can output a frequency or amplitude that is offset (positive or negative) *from* the entered value.

RF Output = entered value – offset value

Displayed Value = output frequency + offset value

To set an offset:

- *Frequency:* Press **Freq > Freq Offset > offset value > frequency unit.**

- *Amplitude:* Press **Amptd** > **More** > **Amptd Offset** > *offset value* > **dB**.

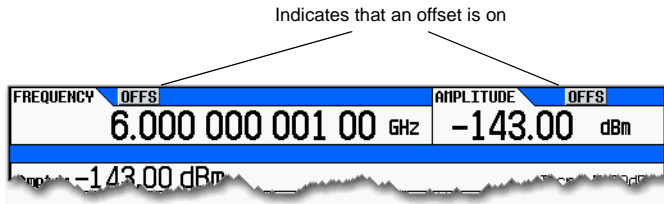

### Examples

Parameter	Example #1	Example #2	Example #3	Comments
Entered (and displayed) Value:	300 MHz	300 MHz	2 GHz	The entered value must be positive.
Offset:	50 MHz	-50 MHz	-1 GHz	An offset value can be positive or negative.
Output Frequency:	250 MHz	350 MHz	3 GHz	The signal generator alerts you if the output frequency or amplitude is out of range.

When using the signal generator as a local oscillator (LO), you can use the offset to display the frequency of interest, as illustrated below:

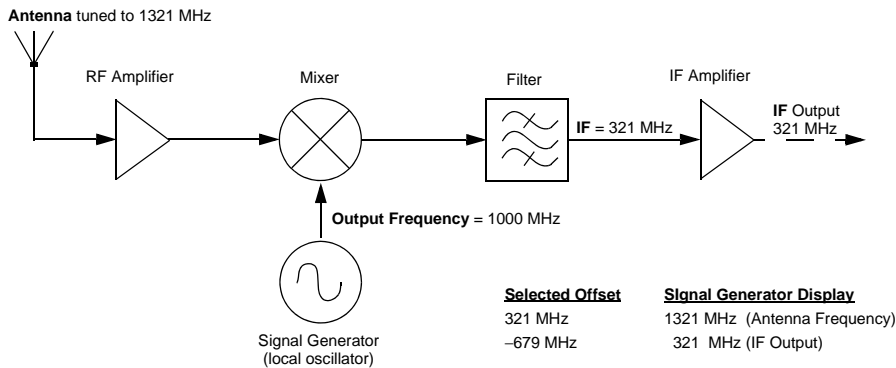

### Setting an Output Reference

Using an output reference, the signal generator can output a frequency or amplitude that is offset (positive or negative) *by* the entered value *from* a chosen reference value.

$$\text{RF Output} = \text{reference value} + \text{entered value}$$

To set a reference:

1. Set the frequency or amplitude to the value you want as the output reference level.
2. *Frequency:* Press **Frequency** > **Freq Ref Set**  
The frequency displays 0.00 Hz, indicating that this is the RF output frequency “zero level.”



All frequencies entered are interpreted as being relative to this reference frequency.

*Amplitude:* Press **Amptd** > **More** > **Amptd Ref Set**

The amplitude displays 0.00 dB, indicating that this is the RF output amplitude “zero level.”

All amplitudes entered are interpreted as being relative to this reference amplitude.

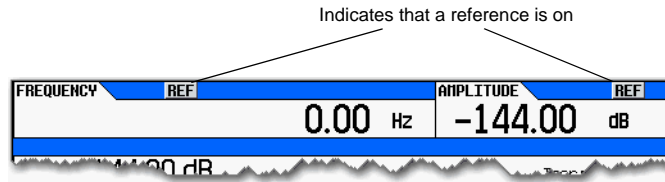

## Examples

Parameter	Example #1	Example #2	Example #3	Comments
Reference:	50 MHz	50 MHz	2 GHz	A reference value must be positive.
Entered (and displayed) Value:	2 MHz	-2 MHz	-1 GHz	The entered value can be positive or negative.
Output Frequency:	52 MHz	48 MHz	1 GHz	The signal generator alerts you if the output frequency or amplitude is out of range.

To set a new frequency or amplitude reference, turn the frequency reference off, and then follow the steps above.

## Setting a Frequency Multiplier

Using a frequency multiplier, the signal generator can display a frequency that is the multiple (positive or negative) of the output value.

Displayed Value = multiplier value × output frequency

Output Frequency = displayed value ÷ multiplier value

To set a frequency multiplier:

1. Press **Frequency** > **Freq Multiplier** > *multiplier value* > **x**.
2. Set the desired frequency.  
The display equals the output frequency times the multiplier value.

Indicates that a frequency multiplier is on

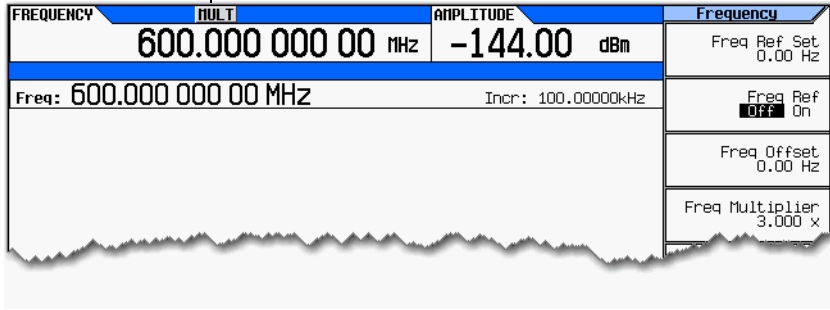

**Examples**

Parameter	Example #1	Example #2	Example #3	Comments
Frequency Multiplier:	3	-3	4	The multiplier range can be set from: +0.001 to +1000 -1000 to -0.001
Entered (and displayed) Value:	600 MHz	-600 MHz	8 GHz	
Output Frequency:	200 MHz	200 MHz	2 GHz	The signal generator alerts you if the output frequency is out of range.

When using the signal generator as the input to a system, you can set the frequency multiplier so that the signal generator displays the output of the system, as illustrated below using a doubler:

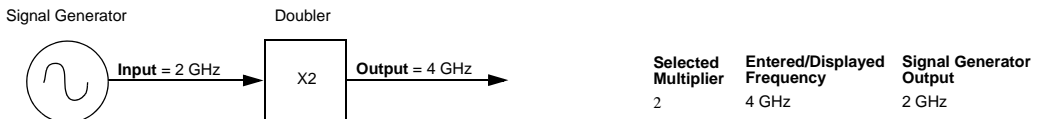

When measuring mixers, the frequency multiplier and frequency offset are often used together. In the upconverter example below, the multiplier is set to -1 and the offset is set to 3 GHz so that the

signal generator displays  $f_{RF}$ .

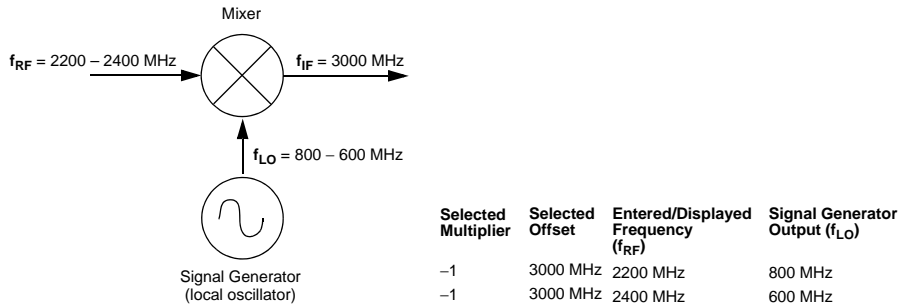

## Using the Frequency and Phase Reference Softkeys

The MXG can be set to have either a user-determined frequency or phase reference.

Figure 5-26 Frequency Reference and Frequency Offset Softkeys

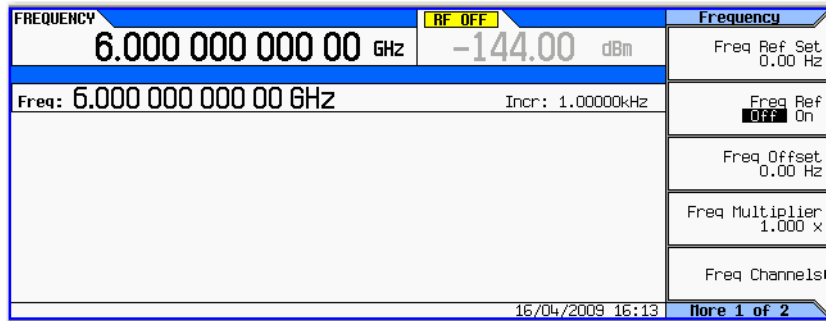

## Using Free Run, Step Dwell, and Timer Trigger

Free Run, Step Dwell (time), and Timer Trigger can be used to adjust the time spent at any point in a Step Sweep or a List Sweep. There are two possible measurement combinations:

*Free Run with Step Dwell time* (Figure 5-27 on page 119) the signal generator waits for the signal to settle and then waits for the Step Dwell time, then it jumps to the next frequency point. In addition, the time to complete the entire sweep can vary. There is *always* a minimum value of Step Dwell for each frequency point. The minimum Step Dwell timing for any point is fixed at a value of 100 us. The time between frequency points is the sum of the settling time, plus the Step Dwell time. The settling time is dependent on frequency, amplitude, band crossings, and other factors, so the time between frequency points can vary.

*Timer Trigger instead of Free Run* (Figure 5-27 on page 119) the signal generator generates equally spaced triggers, and it moves to the next point at each trigger. This has the advantage that the time between points is consistent and the overall sweep time is consistent. But, if the trigger is too fast, the signal may not have time to settle before jumping to the next point.

### **Understanding Free Run, Step Dwell, and Timer Trigger Setup**

If the signal is to be settled for a minimum specific time at each point and it is *not* important if the point to point time is consistent, use **Free Run** and **Set Dwell** time.

If the signal's point to point time requires consistency but the specific settling time at each point can vary, then use the Timer Trigger. Avoid using too fast of a sweep which does *not* allow the signal generator to settle.

If the signal needs to be settled for a specific minimum time *and* consistent point to point time is required, then you should set the Timer Trigger to be the sum of the switching time (900 us or 5 ms, depending on options) *plus* the minimum settled time that is needed to make the measurement.

If the measurement requires external equipment synchronization, consider using hardware triggers.

Figure 5-27 Free Run, Set Dwell, and Timer Trigger Softkeys

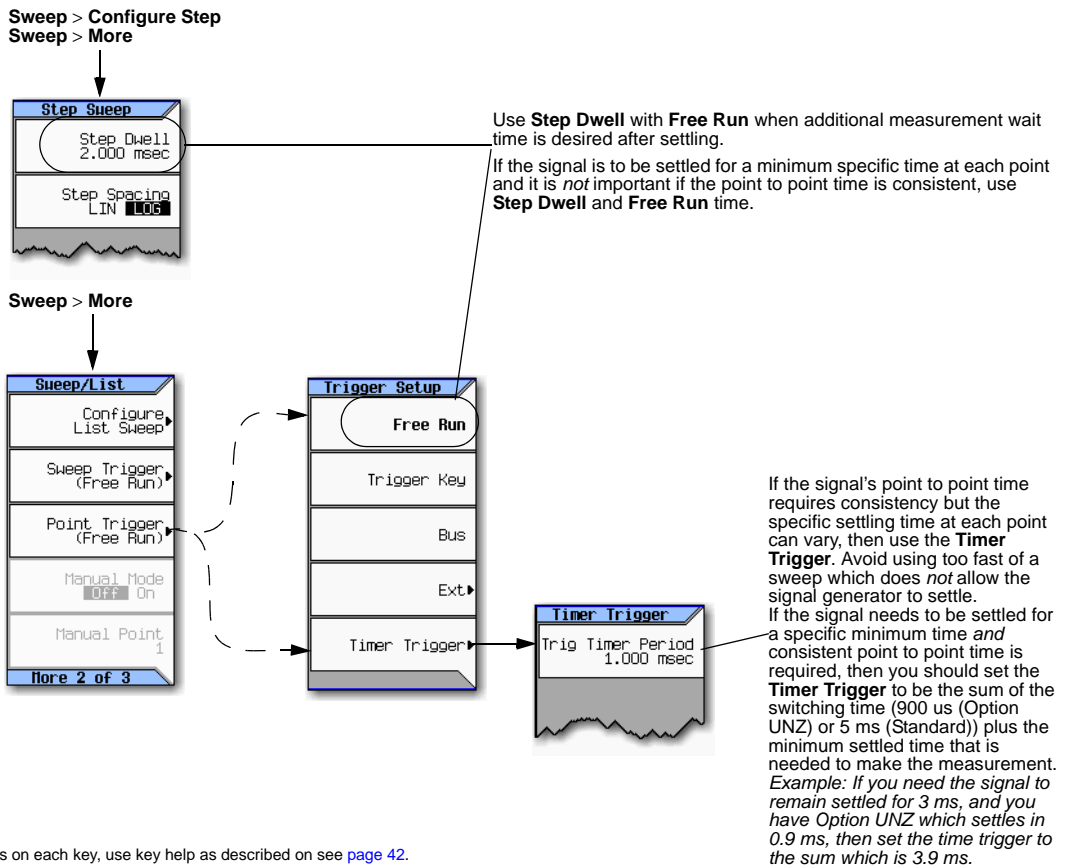

## Using LXI (Option ALB)

---

### NOTE LXI Class B Compliance Disclaimer

As of this product firmware release in June 2008, LXI Class B Compliance Tests, using the new IEEE 1588–2008 Precision Time Protocol (PTP), were not available. This product provides the features of an LXI Class B instrument by adding LAN Triggering and Time Synchronization to its LXI Class C compliance. References to LXI Class B in the document, instrument menus and web pages do not insure LXI Class B compliance. This product will apply for LXI Class B Compliance when the LXI Consortium has approved its specification changes and can provide certified testing. Refer to <http://www.lxistandard.org/home>.

LXI-B is only available on instruments with serial prefixes  $\geq$ US/MY/SG4818.

---

The LXI Standard (LAN eXtensions for Instruments) brings the connectivity of the internet to the Test and Measurement industry. LXI adds a number of tools that a system integrator may use to improve the efficiency of his measurements and improve his visibility into his system.

This section assumes the user is well acquainted with LXI terminology and use models. Also, this section assumes that the user has read and understands the [Chapter 3, “Basic Operation.”](#) Refer to the *Programming Guide* and to [www.lxistandard.org](http://www.lxistandard.org).

### Understanding LXI Clocks

In the simplest test system, one Personal Computer (PC) connects to one LXI instrument through LAN. The PC has its own internal or browser clock and the LXI instrument has two clocks: the Operating System Clock (MS Windows, Windows CE, VX Works, etc.) and the PTP clock. This is shown in the following illustration.

**Figure 5-28 LXI PC with Clock (Browser Clock) and MXG (Operating System Clock and PTP Clock)**

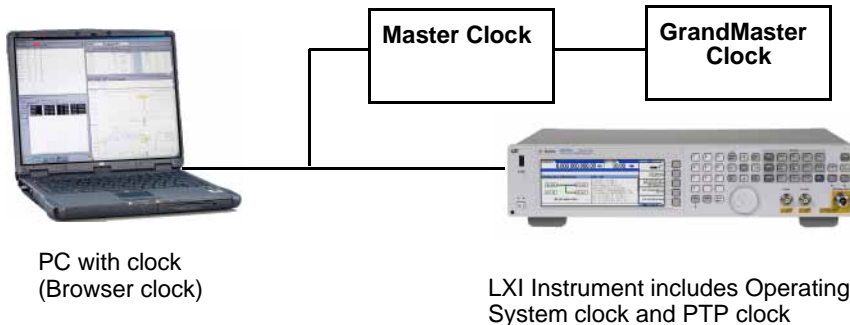

The PC browser clock shows the local civil time using a standard Date/Time representation. If the PC is connected to a Network Time Protocol (NTP) server (through LAN), then its time will be relatively accurate. However, because the PC may be in a different time zone or have a different Daylight Savings Time offset (or both) than the instrument, it is possible for the PC Browser clock to have a different time than the Instrument's Operating System (OS) clock.

The LXI instrument has two clocks. The instrument's Operating System clock, similar to a PC's browser clock, shows civil time in a Date/Time format. The second clock is the instrument's PTP clock. It is this clock that synchronizes to the Master Clock (if one is in the system). Typically, this PTP clock shows time in elapsed seconds since its epoch.

As you create larger systems by adding more LXI instruments, the total number of system clocks increases significantly. In addition to instrument clocks, you may have PTP Master clocks and a PTP GrandMaster clock. Also, you may have one or more Boundary Clocks in your test system. Boundary Clocks will have both Master and Slave clocks depending on the port.

---

**NOTE** The concept of *local clock* or *local time* can be confusing depending on your frame of reference. For example, if you think of yourself in front of the PC, then *local* is the Browser clock. If you think of yourself in front of the instrument, then *local* is the instrument. In most test systems, the PC and the instrument are located close together. But, in some test systems they may be located many miles apart, in different timezones, or even across an ocean. Also note that the SCPI uses *local* in the context of the instrument OS clock.

---

## Getting Started With LXI

The following configurations provide the basic functionality of the LXI softkeys.

**NOTE** Enabling the LXI subsystem effects switching speed.

For optimal switching speed, disable the LXI subsystem when not in use.

**Figure 5-29** Configuring the LXI subsystem

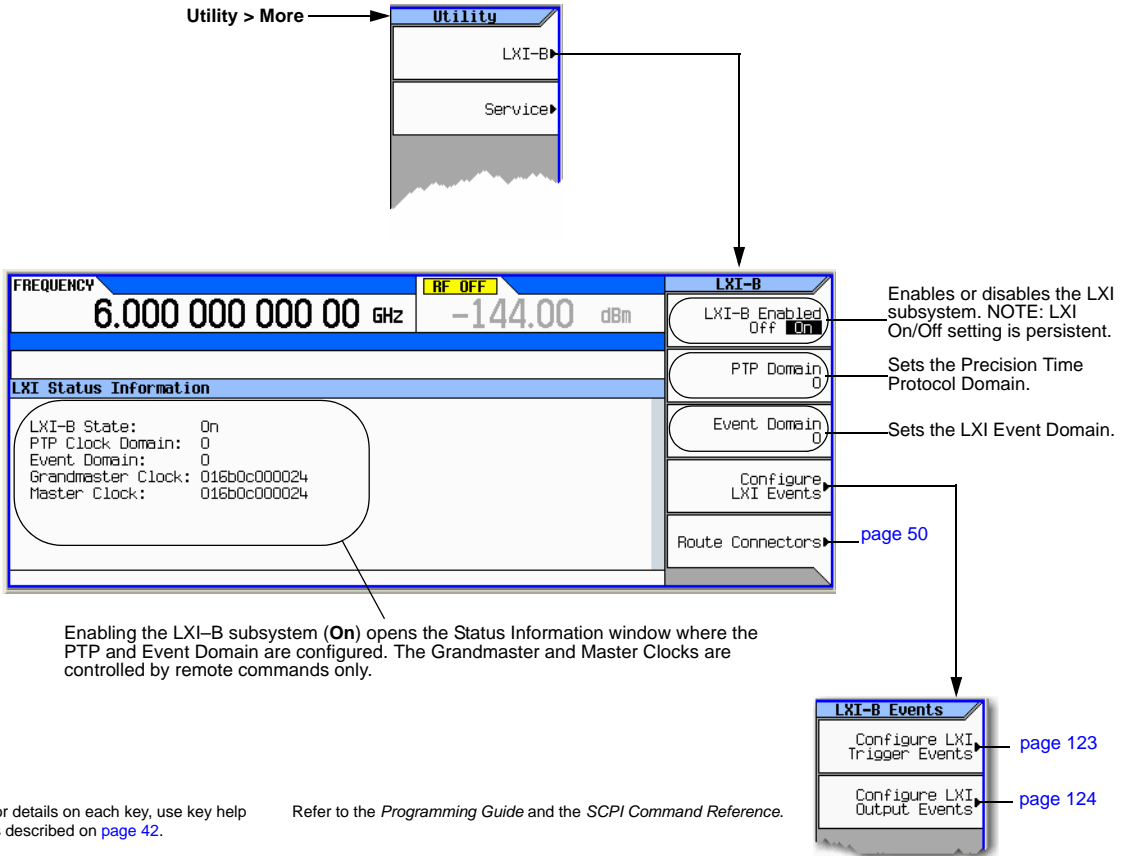



**Figure 5-30 Configuring LXI Trigger Input Events**  
Utility > More > LXI

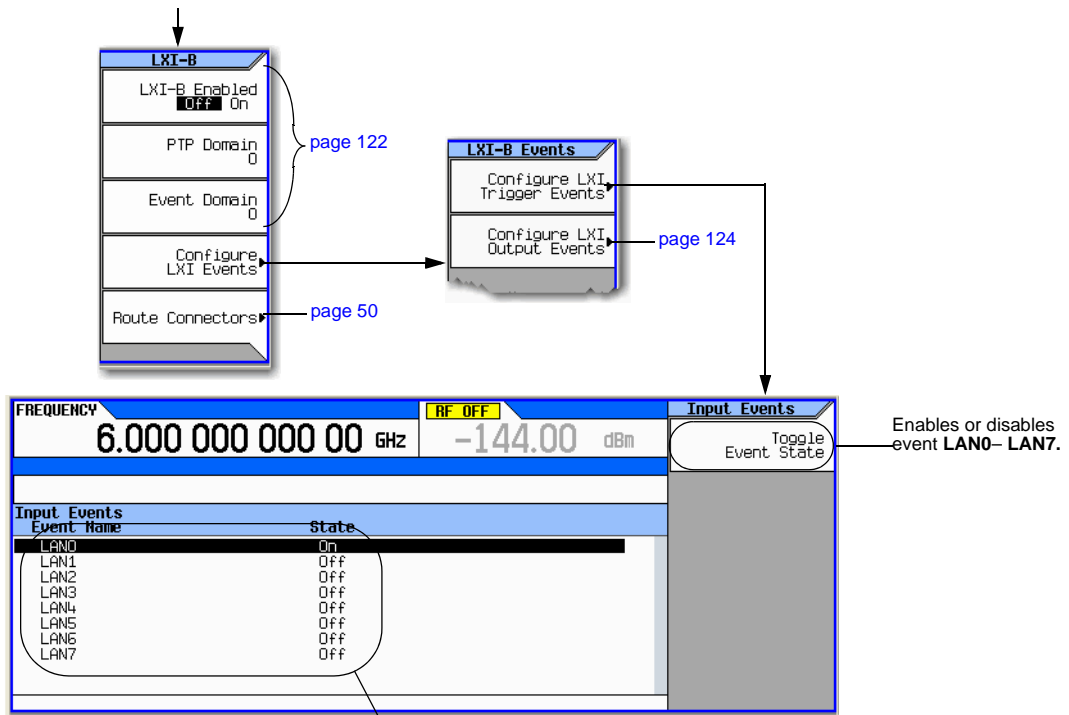

These are the pre-defined default input LAN event identifiers and can not be deleted. An incoming LAN event is treated as a trigger. The trigger event identifier must be enabled (**On**) and the **LXI LAN** (page 49) selected as the source of the trigger.

For details on each key, use key help as described on page 42.

Refer to the *Programming Guide* and the *SCPI Command Reference*.

**Figure 5-31 Configuring LXI Output Events**

Utility > More > LXI

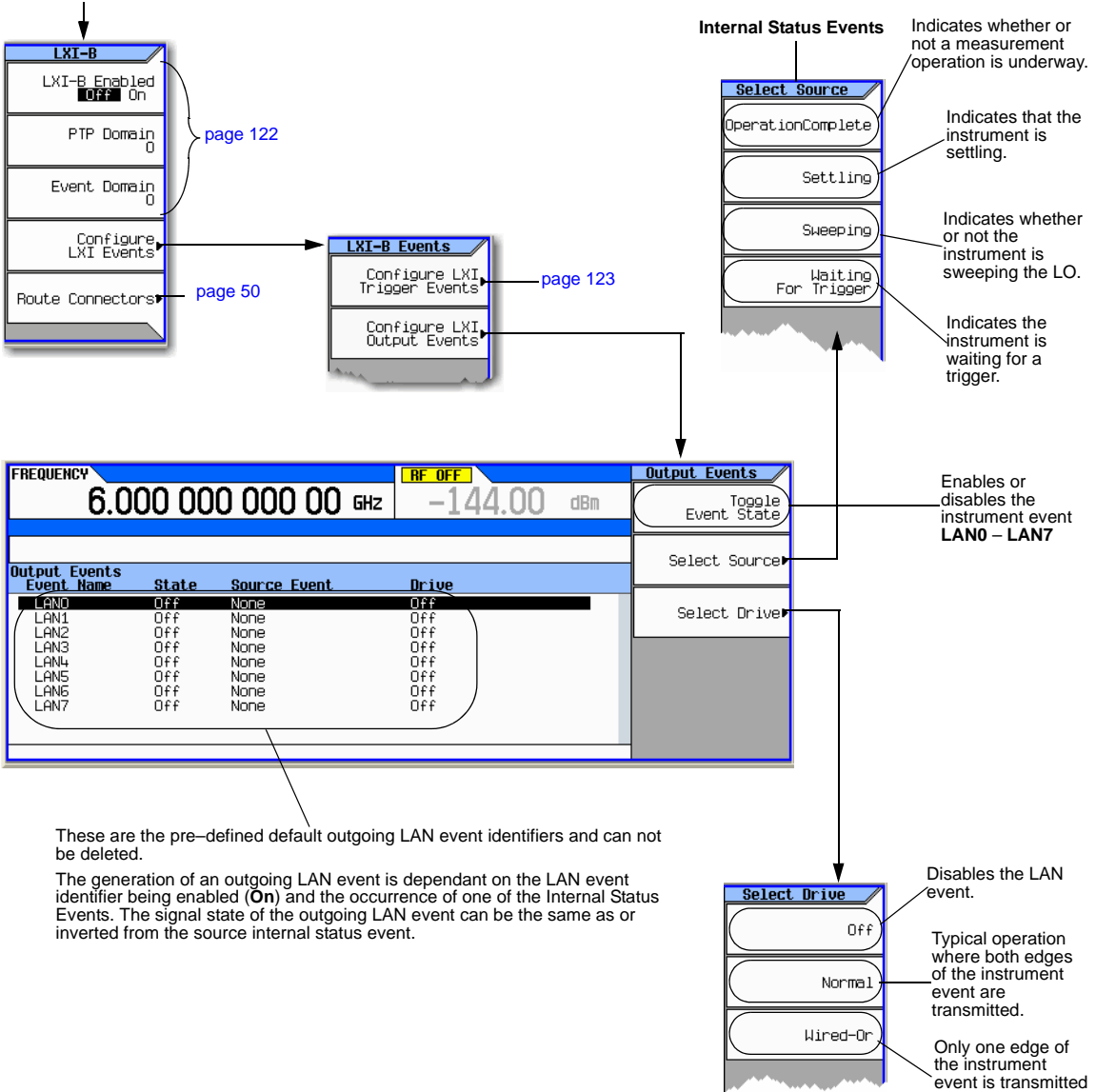

These are the pre-defined default outgoing LAN event identifiers and can not be deleted.

The generation of an outgoing LAN event is dependant on the LAN event identifier being enabled (**On**) and the occurrence of one of the Internal Status Events. The signal state of the outgoing LAN event can be the same as or inverted from the source internal status event.

For details on each key, use key help as described on page 42.

Refer to the *Programming Guide* and the *SCPI Command Reference*.

## For More Information

For more information on using LXI see the Agilent website dedicated to LXI instrumentation:

*[www.agilent.com/find/lxi](http://www.agilent.com/find/lxi)*.

Agilent LXI Application Notes:

- Using LXI to go beyond GPIB, PXI and VXI (AN 1465-20)
- 10 Good Reasons to Switch to LXI (AN 1465-21)
- Transitioning from GPIB to LXI (AN 1465-22)
- How to Use VXI and PXI in Your New LXI Test System (AN 1465-23)
- Using Synthetic Instruments in Your Test System (AN 1465-24)
- Migrating system software from GPIB to LAN/LXI (AN 1465-25)
- Modifying a GPIB System to Include LAN/LXI (AN 1465-26)

## Using a USB Keyboard

You can use a USB keyboard to remotely control the RF output state, the modulation state, and to select a memory sequence and register.

The register selection, RF output state, and modulation state are affected by power cycle or preset, but the USB keyboard control state and the sequence selection are not.

**CAUTION** To avoid the loss of data, GPIB settings, or current user instrument states that have not been permanently saved to non-volatile memory, the MXG should always be powered down either via the MXG's front panel power button or the appropriate SCPI command. MXG's installed in rack systems and powered down with the system rack power switch rather than the MXG's front panel switch display a Error -310 due to the MXG not being powered down correctly.

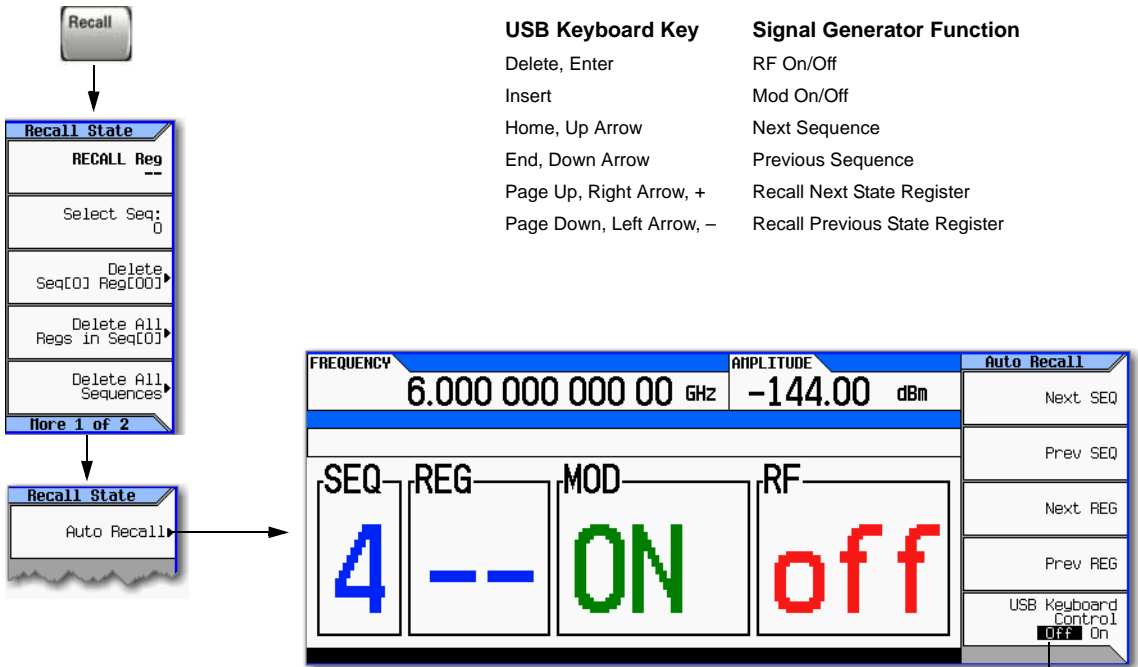

Turning the USB keyboard control off disables the USB keyboard; it has no effect on the Auto Recall softkeys.

For details on each key, use key help as described on see [page 42](#).

---

## 6 Using Pulse Modulation (Option UNU or UNW or 320)

---

**NOTE** For the N5161A/62A the softkey menus and features mentioned in this guide are only available through the Web-Enabled MXG or SCPI commands. For information on the Web-Enabled MXG, refer to the *Installation Guide*, the *Programming Guide*, and to the *SCPI Command Reference*.

---

Before using this information, you should be familiar with the basic operation of the signal generator. If you are not comfortable with functions such as setting the power level and frequency, refer to [Chapter 3, “Basic Operation,” on page 41](#) and familiarize yourself with the information in that chapter.

- [Pulse Characteristics](#) on page 129
- [The Basic Procedure](#) on page 131
- [Example](#) on page 131
- [Pulse Train \(Option 320 – Requires: Option UNU or UNW\)](#) on page 132

Figure 6-1 Pulse Softkeys

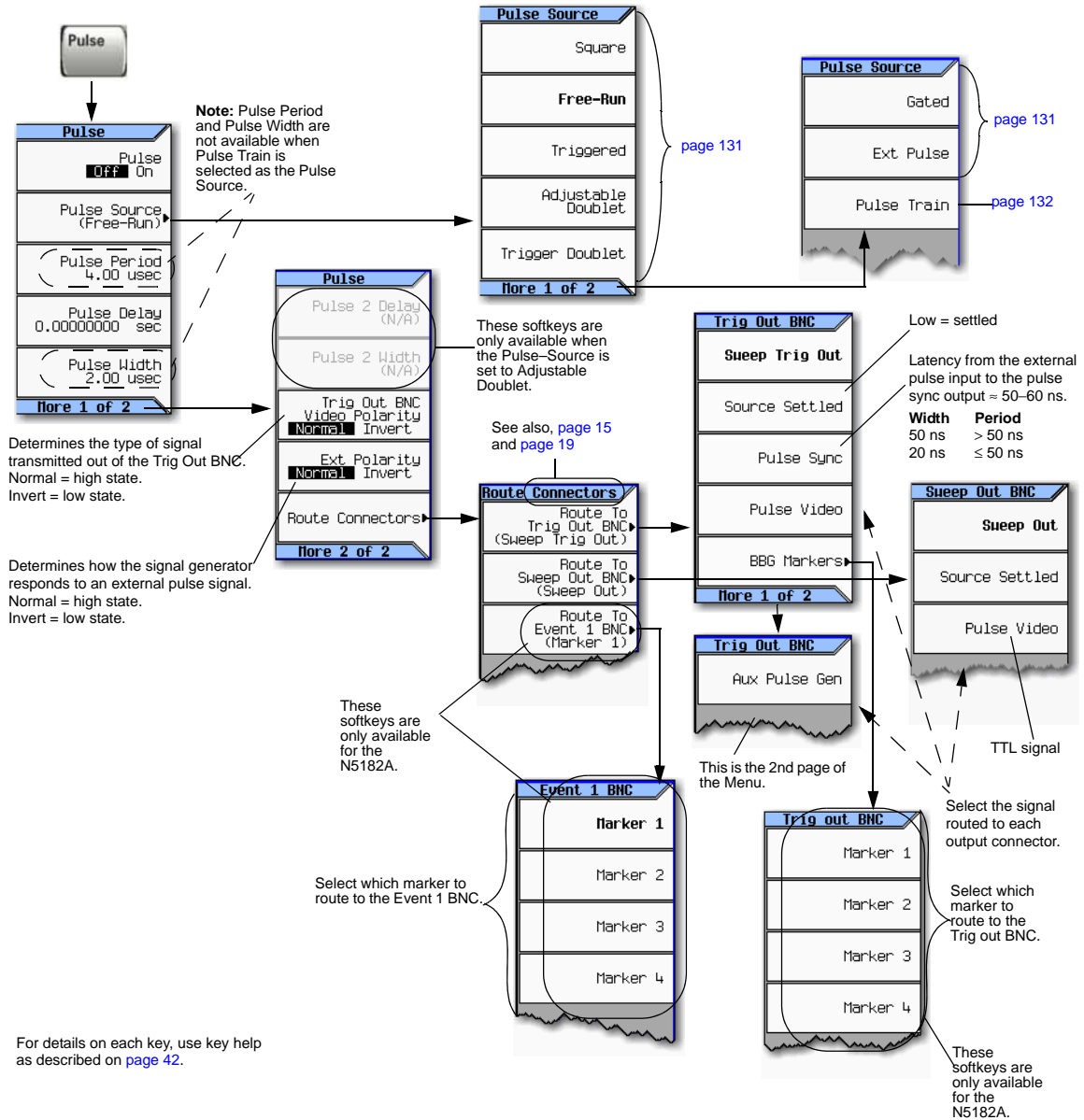

## Pulse Characteristics

**NOTE** When using very narrow pulses that are below the signal generator's ALC pulse width specification, or leveled pulses with an unusually long duty cycle, it is often useful to turn ALC off (see [page 110](#)).

Pulse Source	Type	Period <sup>a</sup>	Width & Delay <sup>a</sup>	Uses Trigger Event <sup>b</sup>
Square	Internal free run pulse train with 50% duty cycle.	Determined by user defined rate.	—	—
Free Run (default)	Internal free run pulse train	User Defined	User Defined	—
Triggered	Internal pulse train	—	User Defined	3
Adjustable Doublet	Two internal pulse trains for each trigger event.	—	User Defined: First pulse is relative to the rising edge of trigger signal. Second pulse is relative to the rising edge of first pulse. See <a href="#">Figure 6-2 on page 130</a>	3
Trigger Doublet	Two internal pulse trains for each trigger event.	—	The first pulse follows the trigger signal. Second pulse is user defined. See <a href="#">Figure 6-3 on page 130</a>	3
Gated	Internal gated pulse train	—	User Defined	3
External	External pulse signal at the rear panel Pulse connector	—	—	—
Pulse Train	Internal pulse train	User Defined	User Defined: See <a href="#">Figure 6-4 on page 133</a>	3

<sup>a</sup>All delays, widths, and periods have a resolution of 10 ns.

<sup>b</sup>A signal at the rear panel pulse connector must be held high for at least 20 ns to trigger an internally generated pulse.

Rear panel inputs are described on [page 15](#)

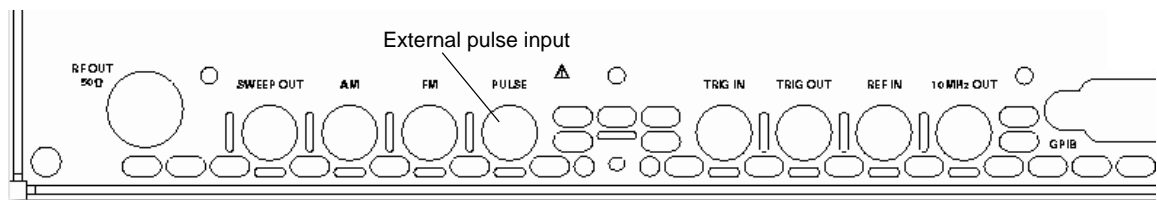

**Figure 6-2 Adjustable Doublet**

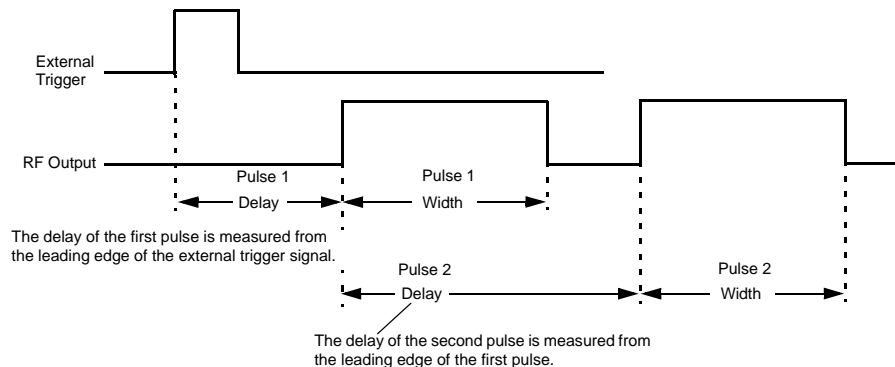

**Figure 6-3 Trigger Doublet**

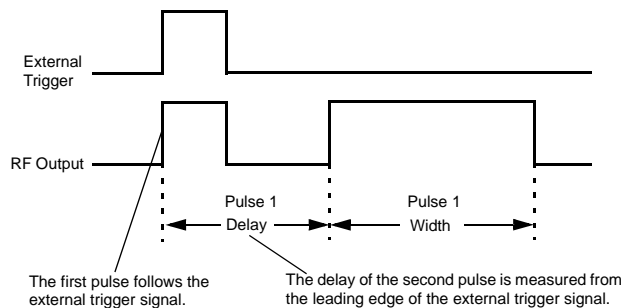



## The Basic Procedure

1. Preset the signal generator.
2. Set the carrier (RF) frequency.
3. Set the RF amplitude.
4. Configure the modulation:
  - a. Set the pulse source: Press **Pulse > Pulse Source > selection**
  - b. Set the parameters for the selected pulse source:

Square	Free Run (default)	Triggered	Adjustable Doublet	Trigger Doublet	Gated	Pulse Train <sup>a</sup>	External
Pulse Rate	—	—	—	—	—	—	—
—	Pulse Period	—	—	—	Pulse Period	—	—
—	Pulse Delay	Pulse Delay	Pulse Delay	Pulse Delay	—	Pulse Delay	—
—	Pulse Width	Pulse Width	Pulse Width	Pulse Width	Pulse Width	—	—
—	—	—	Pulse 2 Delay	—	—	—	—
—	—	—	Pulse 2 Width	—	—	—	—
—	—	—	—	—	—	Pulse On <sup>b</sup>	—
—	—	—	—	—	—	Pulse Off <sup>b</sup>	—

<sup>a</sup> Requires Option 320.

<sup>b</sup> Up to 2047 pulse cycles (elements) composed of both Pulse On and Pulse Off can be user defined.

5. Turn on the modulation: **Pulse Off On** softkey to On.  
The the PULSE annunciator lights, indicating that you enabled modulation.
6. Output the modulated signal from the signal generator: Press the front panel **RF On Off** key.  
The RF output LED lights, indicating that the signal is transmitting from the RF output connector.  
See also, [“Modulating the Carrier Signal” on page 60.](#)

## Example

The following example uses the factory preset pulse source and delay.

**Output:** A 2 GHz, 0 dBm carrier modulated by a 24  $\mu$ s pulse that has a period of 100  $\mu$ s.

1. Preset the signal generator.
2. Set the frequency to 2 GHz.
3. Set the amplitude to 0 dBm.

4. Set the pulse period to 100 microseconds: Press **Pulse > Pulse Period > 100 > usec**.
5. Set the pulse width to 24 microseconds: Press **Pulse > Pulse Width > 24 > usec**
6. Turn on both the pulse modulation and the RF output.

The PULSE annunciator displays and the RF output LED lights.

If the modulation does not seem to be working properly, refer to [“No Modulation at the RF Output” on page 318](#).

## **Pulse Train (Option 320 – Requires: Option UNU or UNW)**

The Option 320 Pulse Train feature enables the specification of up to 2047 independent pulse cycles, each of which has an “On Time”, during which the RF output is measurable at the RF output connector, and an “Off Time”, during which the RF output is attenuated. Each pulse cycle is similar in function to other MXG Pulse modes—the new feature has up to 2047 cycles, instead of only a maximum of two (with Doublets). There are also repeat counts available for each pulse. These repetitions count against the total count of 2047 cycles.

The instrument can import pulse trains from a .csv (comma separated values) file or some other common ASCII format. It can also export to ASCII/CSV files as well. Export allows specification of the decimal separator and a column separator. The import allows specification of the decimal separator (to allow for “.”), but the column separator is auto-detected. Refer to [“Pulse Train Menu Softkeys” on page 133](#) and [“Display Pulse Train Menu Softkeys” on page 134](#).

Figure 6-4 Pulse Train Menu Softkeys

Pulse > Pulse Source > More >  
Pulse Train

For details on each key, use key help as described on page 42.

The screenshot shows the main interface with the following data:

- FREQUENCY: 6.000 000 000 00 GHz
- RF OFF: -144.00 dBm
- Modulation Status Information:
 

Mod	State	Depth/Dev	Source	Rate	Waveform
AM	Off	0.1%	Internal	400.0Hz	Sine
AM HB	Off		I Input		
FM	Off	1.0000kHz	Internal	400.0Hz	Sine
PM	Off	0.000rad	Internal	400.0Hz	Sine
<b>Pulse</b>	<b>On</b>	<b>Int Triggered</b>	<b>Train</b>		
Burst	Off		Int		
I/Q	Off		Internal		
- Pulse: Off On
- Pulse Source (Pulse Train)
- Pulse Delay: 0.0000000 sec
- Edit Pulse Train
- Date/Time: 28/04/2010 16:23
- More 1 of 2

Display area indicates Pulse Train is the current pulse source.

Note: the Pulse Train is always triggered, so the Triggering softkey is not available in the Pulse menu.

These softkeys provide ease of use in changing the pulse cycle settings in the pulse train.

The screenshot shows the Pulse Train menu with the following data:

- FREQUENCY: 6.000 000 000 00 GHz
- RF OFF: -144.00 dBm
- Pulse Train Table:
 

	On Time	Off Time	Repeat
1	2.000 us	2.000 us	1
2	3.000 us	2.000 us	2
4	2.000 us	2.000 us	1
5	3.000 us	2.000 us	3
8	2.000 us	2.000 us	1
9			
- Edit Item
- Insert Row
- Delete Row
- Goto Row
- Display Pulse Train
- Date/Time: 28/04/2010 06:54
- More 1 of 2

This column indicates the row of a each pulse train cycle.

This column displays the on times for each pulse cycle (element) in the pulse train.

This column displays the off times for each pulse cycle (element) in the pulse train.

This column displays the repeat times for each pulse cycle (element) in the pulse train.

Note: When the cycles (elements) are repeated, the row numbers are skipped in the displayed count for the number of pulse cycles repeated.

Example: For the pulse train displayed above, in row 2, the 3 us On Time and 2 us Off Time pulse cycle is repeated twice. But, only row 2 is displayed for that pulse cycle (i.e. row 3 is not displayed).

SCPI Commands:

```
[ :SOURCE ] :PULM:INTernal:TRain:LIST:PRESet
[ :SOURCE ] :PULM:INTernal:TRain:OFFTime <20ns - 42sec>
[ :SOURCE ] :PULM:INTernal:TRain:OFFTime?
[ :SOURCE ] :PULM:INTernal:TRain:OFFTime:POINTs?
[ :SOURCE ] :PULM:INTernal:TRain:ONTime <20ns - 42sec>
[ :SOURCE ] :PULM:INTernal:TRain:ONTime?
[ :SOURCE ] :PULM:INTernal:TRain:ONTime:POINTs?
[ :SOURCE ] :PULM:INTernal:TRain:REPetition <1-2047>
[ :SOURCE ] :PULM:INTernal:TRain:REPetition?
[ :SOURCE ] :PULM:INTernal:TRain:REPetition:POINTs ?
```

Refer to SCPI Command Reference.

SCPI Commands (continued):

```
:MEMory:CATalog:PTRain?
:MEMory:DElete:PTRain
:MEMory:EXPort[:AScii]:PTRain <"filename">
:MEMory:EXPort[:AScii]:SEPARATOR:COLumn TAB|SEMIColon|{COMMA}|SPACE
:MEMory:EXPort[:AScii]:SEPARATOR:COLumn?
:MEMory:EXPort[:AScii]:SEPARATOR:DECimal {DOT}|COMMA
:MEMory:EXPort[:AScii]:SEPARATOR:DECimal?
:MEMory:IMPort[:AScii]:PTRain <"filename">
:MEMory:IMPort[:AScii]:SEPARATOR:DECimal {DOT}|COMMA
:MEMory:IMPort[:AScii]:SEPARATOR:DECimal?
:MMEMory:LOAD:PTRain <"filename">
:MMEMory:STORe:PTRain <"filename">
```

- Goto Row
- Enter
- Goto Top Row
- Goto Middle Row
- Goto Bottom Row

- Pulse Train
- Load/Store
- Import/Export
- Insert Item
- Delete Item
- Delete All Rows
- More 2 of 2

**Figure 6-5 Display Pulse Train Menu Softkeys**

Pulse > Pulse Source > More > Pulse Train >  
 Edit Pulse Train > Display Pulse Train

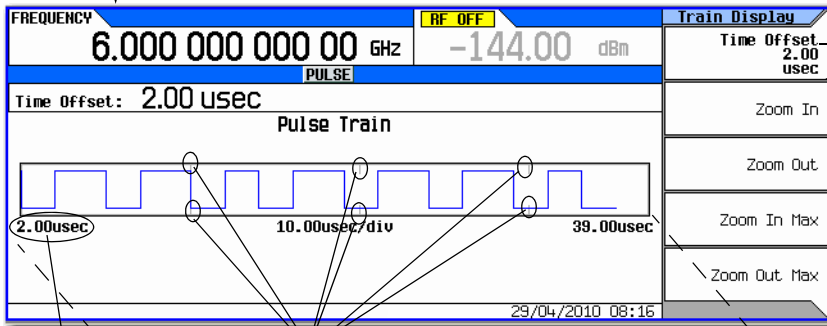

This softkey shifts the time offset from the left hand side of the display to the one specified. Increments and decrements are 1/20th of the visible pulse train.

Use these softkeys to optimize the view of the different characteristics of the pulse train.

This value can be adjusted with the Time Offset softkey.

These are the division markers currently set at 10.00 us/div for the currently displayed view. Use the zoom softkeys to change the time/div value.

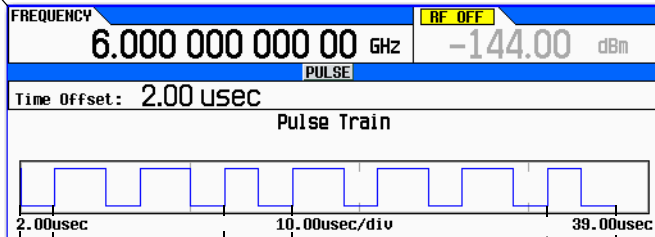

This is the initial pulse cycle (row 1) note that the On Time portion of this pulse is not showing due to the 2 us offset.

2nd and 3rd pulse cycles (elements) or rows 2 and 3.

4th pulse cycle (element) or row 4.

5th, 6th, and 7th pulse cycles (elements) or rows 5, 6, and 7.

Final pulse cycle (element) in the displayed pulse train above. 8th pulse cycle or row number 8.

For details on each key, use key help as described on [page 42](#).

Figure 6-6 Pulse Train: Import From Selected File Softkeys

Pulse > Pulse Source > More > Pulse Train > Edit Pulse Train > More

For details on each key, use key help as described on page 42.

**Confirm Import**  
Confirm Import From File

**Import/Export**  
Import From Selected File  
Export To File  
Delete File  
Goto Row  
Import Decimal Separator  
Dot Comma

**Pulse Train**

	On Time	Off Time	Repeat
1	2.000 us	2.000 us	1
2	3.000 us	2.000 us	2
4	2.000 us	2.000 us	1
5	3.000 us	2.000 us	3
8	2.000 us	2.000 us	1

03/05/2010 15:22 **More 2 of 2**

**Import/Export**  
32.7MB used 465MB free  
File Name Type Size Modified  
1 DISPLAY.BMP BINARY 76918 22/09/06 22:36  
2 DRIV1PH.LIC BINARY 524 22/09/06 22:36  
3 LAUNCH3\_EXE BINARY 925696 22/09/06 22:36  
4 PTRAIN.CSV BINARY 55 04/05/10 08:47  
5 PTRAIN.TXT BINARY 55 04/05/10 08:43  
6 PTRAIN2.CSV BINARY 15 04/05/10 09:08  
7 WMPINFO.XML BINARY 296 22/09/06 22:37

04/05/2010 09:17 **More 1 of 2**

**PTRAIN.csv - Notepad**  
File Edit Format View Help  
0.000000.000000.2  
0.000000.000000.3  
0.000000.000000.2

Note: Column separated values are auto-detected by the MXG.

This file's data structure uses decimals in the numbers and so requires the Import Decimal Separator to be set to Dot.  
This value is persistent across preset/recall and power cycles.

SCPI Commands:  
:MEMory:IMPorT[:ASCIi]:SEParato  
r:DECimal DOT|COMMa  
:MEMory:IMPorT[:ASCIi]:SEParato  
r:DECimal?

**Pulse Train**

	On Time	Off Time	Repeat
1	2.000 us	1.000 us	2
3	4.000 us	2.000 us	3
6	2.000 us	3.000 us	2
8	-----	-----	-----

Pulse train imported as CSV

After confirming import of the file the new file's pulse train values are displayed.

Figure 6-7 Pulse Train: Export to File Softkeys

Pulse > Pulse Source > More > Pulse Train > Edit Pulse Train > More

Note: Files can be FTP'd to the BIN (Binary) folder in the MXG or a USB stick can be used to download the files to the MXG. Refer to page 67.

Selects whether the decimal point is a "." or "," during export of the CSV/ASCII files. This value is persistent across preset/recall and power cycles.

SCPI Commands:  
 :MEMory:EXPort[:ASCIi]:SEParator:DECimal DOT|COMMa  
 :MEMory:EXPort[:ASCIi]:SEParator:DECimal?

Selects whether the column separator is a tab, ",", "." or "a " during export of the CSV/ASCII files. This value is persistent across preset/recall and power cycles.

SCPI Commands:  
 :MEMory:EXPort[:ASCIi]:SEParator:COLumn  
 TAB|SEMicolon|COMMa|SPACe  
 :MEMory:EXPort[:ASCIi]:SEParator:COLumn?

The Export to File softkey menu, writes out a CSV/ASCII file to the BINARY directory. You may supply your own extender as part of the filename.

Example:  
 MEM:EXP:PTR "myfile.csv".  
 SCPI Command:  
 :MEMory:EXPort[:ASCIi]:PTRain <"filename">

Use the text editor keys to rename the file to be exported to the BIN (Binary) folder.

Note: Since there is already a file named PTRAIN.CSV the new filename should be different, to avoid overwriting the original PTRAIN.CSV file.

For details on each key, use key help as described on page 42.

---

## 7 Basic Digital Operation—No BBG Option Installed

---

**NOTE** For the N5162A the softkey menus and features mentioned in this guide are only available through the Web-Enabled MXG or SCPI commands. For information on the Web-Enabled MXG, refer to the *Installation Guide*, the *Programming Guide*, and to the *SCPI Command Reference*.

---

Before using this information, you should be familiar with the basic operation of the signal generator. If you are not comfortable with functions such as setting power level and frequency, refer to [Chapter 3, “Basic Operation,” on page 41](#) and familiarize yourself with the information in that chapter.

See also [“Adding Real-Time Noise to a Dual ARB Waveform” on page 251](#).

## I/Q Modulation

The following factors contribute to the error vector magnitude:

- Differences in amplitude, phase, and delay between the I and Q channels
- DC offsets

The I/Q menu provides adjustments to compensate for some of the differences in the I and Q signals or to add impairments.

See also “Modulating the Carrier Signal” on page 60.

**Figure 7-1 I/Q Display and Softkeys**

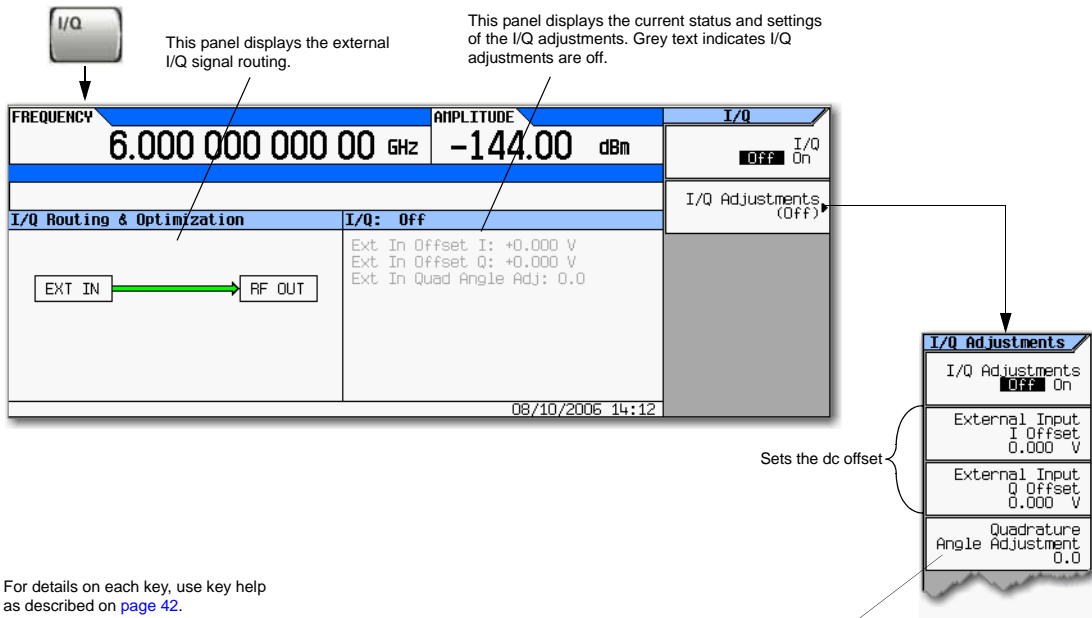

The following table shows common uses for the adjustments.

**Table 7-1 I/Q Adjustments Uses**

I/Q Adjustment	Effect	Impairment
Offset	Carrier Feedthrough	dc offset
Quadrature Angle	EVM error	phase skew
	I/Q Images	I/Q path delay



## Configuring the Front Panel Inputs

The Agilent MXG accepts externally supplied analog I and Q signals through the front panel I Input and Q Input for modulating onto the carrier.

1. Connect I and Q signals to the front panel connectors. For voltage levels, refer to [“Front Panel Overview – N5181A/82A MXG”](#) on page 5.
  - a. Connect an analog I signal to the signal generator’s front panel I Input.
  - b. Connect an analog Q signal to the signal generator’s front panel Q Input.
2. Turn on the I/Q modulator: Press **I/Q Off On** to On.
3. Configure the RF output:
  - a. Set the carrier frequency.
  - b. Set the carrier amplitude.
  - c. Turn the RF output on.
4. Make adjustments to the I/Q signals ([page 138](#)) as needed.



---

## 8 Basic Digital Operation (Option 651/652/654)

---

**NOTE** For the N5162A the softkey menus and features mentioned in this guide are only available through the Web-Enabled MXG or SCPI commands. For information on the Web-Enabled MXG, refer to the *Installation Guide*, the *Programming Guide*, and to the *SCPI Command Reference*.

---

Before using this information, you should be familiar with the basic operation of the signal generator. If you are not comfortable with functions such as setting power level and frequency, refer to [Chapter 3, “Basic Operation,” on page 41](#) and familiarize yourself with the information in that chapter.

The features described in this chapter are available only in vector signal generators with Option 651, 652, or 654.

- [Waveform File Basics](#) on page 142
- [Storing, Loading, and Playing a Waveform Segment](#) on page 144
- [Waveform Sequences](#) on page 147
- [Saving a Waveform's Settings & Parameters](#) on page 151
- [Using Waveform Markers](#) on page 157
- [Triggering a Waveform](#) on page 174
- [Clipping a Waveform](#) on page 181
- [Scaling a Waveform](#) on page 190
- [Setting the Baseband Frequency Offset](#) on page 196
- [I/Q Modulation](#) on page 200
- [I/Q Adjustments](#) on page 203
- [I/Q Calibration](#) on page 205
- [Using the Equalization Filter](#) on page 207
- [Using Finite Impulse Response \(FIR\) Filters in the Dual ARB Real-Time Modulation Filter](#) on page 209
- [Modifying a FIR Filter Using the FIR Table Editor](#) on page 215
- [Setting the Real-Time Modulation Filter](#) on page 219
- [Multiple Baseband Generator Synchronization](#) on page 220
- [Understanding Option 012 \(LO In/Out for Phase Coherency\) with Multiple Baseband Generator Synchronization](#) on page 227
- [Waveform Licensing for Firmware Version  \$\geq\$  A.01.50](#) on page 231
- [Waveform 5-Pack Licensing \(Options 221–229\) for Firmware Version  \$<\$  A.01.50](#) on page 239

See Also:

- [Adding Real-Time Noise to a Dual ARB Waveform](#) on page 251
- [Real-Time Phase Noise Impairment](#) on page 260
- [Multitone and Two-Tone Waveforms \(Option 430\)](#) on page 297

## Waveform File Basics

There are two types of waveform files:

- A *segment* is a waveform file that you download to the signal generator.  
For information on creating and downloading waveform files, refer to the *Programming Guide*.
- A *sequence* is a file you create in the signal generator that contains pointers to one or more waveform files (segments, other sequences, or both).  
For information on creating sequences, see [page 147](#).

## Signal Generator Memory

The signal generator has two types of memory:

- *Volatile* memory, baseband generator (BBG) media, where waveform files are played from or edited.
- *Non-volatile* memory, either internal (int) or external (USB) media, where waveform files are stored.

## Dual ARB Player

---

**NOTE** The MXG's ARB Waveform File Cache is limited to 128 files. Consequently, once the 128 file cache limit has been reached, the waveform switching speed will be much slower for additional files loaded into the volatile waveform memory (BBG).

---

The dual ARB waveform player enables you to play, rename, delete, store, and load (external or internal) waveform files in addition to building waveform sequences. The dual ARB waveform player also provides markers ([page 157](#)), triggering ([page 174](#)), clipping ([page 181](#)), and scaling ([page 190](#)) capabilities.

Most procedures in this section start from the Dual ARB menu, shown below.

Figure 8-1 Dual ARB Softkeys

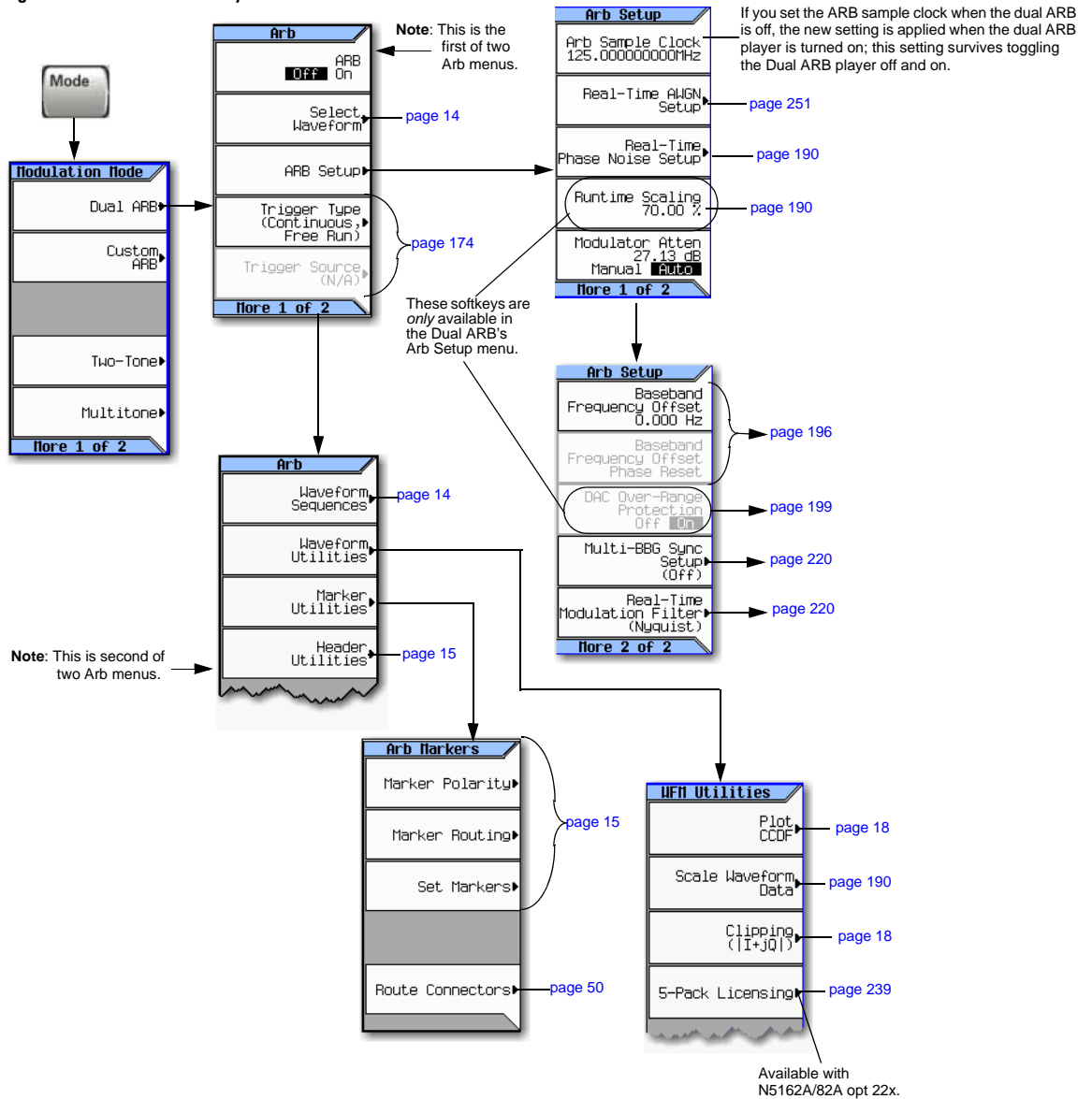

For details on each key, use key help as described on page 42.

## Storing, Loading, and Playing a Waveform Segment

**NOTE** The MXG’s ARB Waveform File Cache is limited to 128 files. Consequently, once the 128 file cache limit has been reached, the waveform switching speed will be much slower for additional files loaded into the volatile waveform memory (BBG).

Before using this information, you should be familiar with the signal generator’s file menus. If you are not, refer to “Working with Files” on page 62 and familiarize yourself with that information.

See also: “Waveform Sequences” on page 147.

The signal generator has two types of waveform media: non-volatile (internal or USB), and volatile (BBG). BBG media is also called “working” media, because before you can play, edit, or include a waveform file in a sequence, the waveform file must be loaded into BBG media.

**Figure 8-2 Waveform Segment Softkeys**

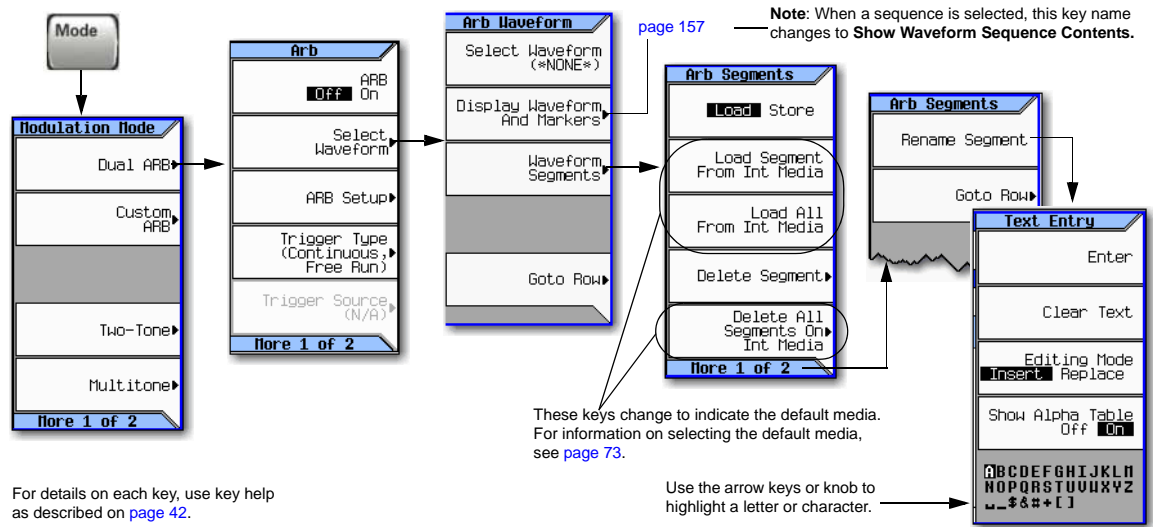

### Loading a Waveform Segment into BBG Media

Waveforms must reside in BBG media before they can be played, edited, or included in a sequence. Cycling power or rebooting the signal generator deletes the files in BBG media.

**NOTE** Each time the instrument powers up, two factory-supplied segments are automatically created in BBG media: RAMP\_TEST\_WFM and SINE\_TEST\_WFM.

There are additional sample waveforms that are available in the internal storage and that can be loaded into memory. Refer to [www.agilent.com](http://www.agilent.com) and search on “Factory Default N5182A” and “waveforms”.

1. Press **Mode** > **Dual ARB** > **Select Waveform** > **Waveform Segments**.

2. Press **Load Store** to highlight Load, then, using the arrow keys, highlight the desired waveform segment.
3. If there is already a copy of this segment in the currently selected media and you do not want to overwrite it, rename the waveform segment before you load it (refer to the previous procedure).
4. Press **Load Segment From** *currently selected Media*.  
To load *all* files from the currently selected media into BBG media, press **Load All From** *currently selected Media*.

### Storing/Renaming a Waveform Segment to Internal or USB Media

Use the following steps to store a copy of a file in BBG memory to the currently selected media (page 73). If you have not downloaded a waveform segment, either refer to the *Programming Guide*, or use one of the factory-supplied segments.

1. Press **Mode > Dual ARB > Select Waveform > Waveform Segments**.
2. Press **Load Store** to highlight Store.
3. Using the arrow keys, highlight the waveform segment you want to store.
4. Optionally, rename the segment.

If there is already a copy of this segment in the currently selected media and you do not want to overwrite it, rename the waveform segment before you store it:

- a. Press **More > Rename Segment > Clear Text**.
  - b. Enter a name for the waveform segment.
  - c. Press **Enter > More**.
  - d. Highlight the waveform segment that was renamed.
5. Press **Store Segment to** *currently selected Media*.
  6. Repeat [Step 3](#) through [Step 5](#) for all segments that you want to store.  
To save *all* segments from BBG media to the currently selected media, press **Store All to** *currently selected Media*.

### Playing a Waveform Segment

1. Press **Mode > Dual ARB > Select Waveform**.
2. In the Segment on BBG Media column, highlight the waveform segment you want to play.
3. Press **Select Waveform**.
4. Set **ARB Off On** to On.

This plays the selected waveform segment. Both the I/Q and ARB annunciators turn on, and the waveform modulates the RF carrier.

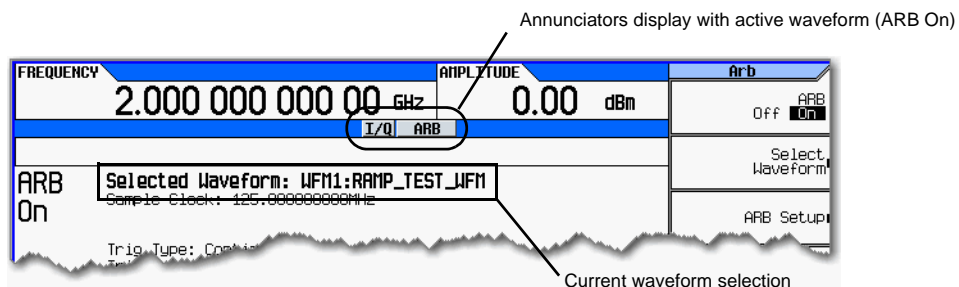

5. Configure the RF Output:

Set the RF carrier frequency and amplitude, and turn on the RF output.

The waveform segment is now available at the signal generator's RF Output connector.



# Waveform Sequences

Figure 8-3 Waveform Sequence Softkeys

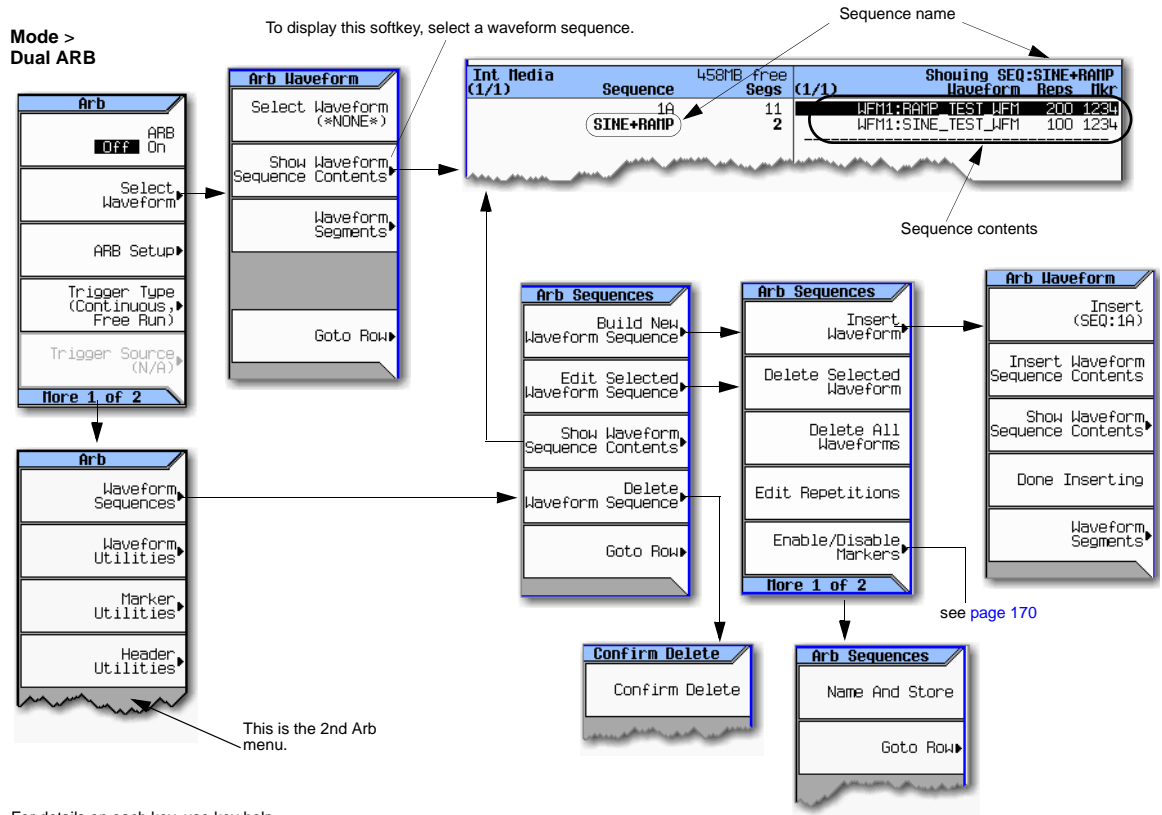

For details on each key, use key help as described on [page 42](#).

A waveform sequence is a file that contains pointers to one or more waveform segments or other waveform sequences, or both. This lets the signal generator play multiple waveform segments, or other sequences, or both thereby eliminating the need to stop waveform playback just to select another waveform.

The segments that a waveform sequence points to are *not* automatically stored when you store the sequence; you must also store the individual segments or they are lost when you turn off or reboot the signal generator. If the segments are located in internal/external media, you must load them into BBG media prior to selecting a waveform sequence (see [page 144](#)). If you attempt to play a sequence without the segments loaded into BBG media, the signal generator reports: ERROR: 629, File format invalid. If this happens and the segments are not stored in internal/external media, you must recreate the segments using the same file names that the sequence points to before you can play the sequence.

## Creating a Sequence

A waveform sequence can contain up to 1,024 segments and have both segments and other sequences (nested sequences). The signal generator lets you set the number of times the segments and nested sequences repeat during play back. But there is a difference between repeating a segment versus repeating a nested sequence. Each segment can repeat up to 65,535 times, but no matter how many times a segment repeats, it counts as a single segment. However each repetition of a nested sequence counts as additional segments.

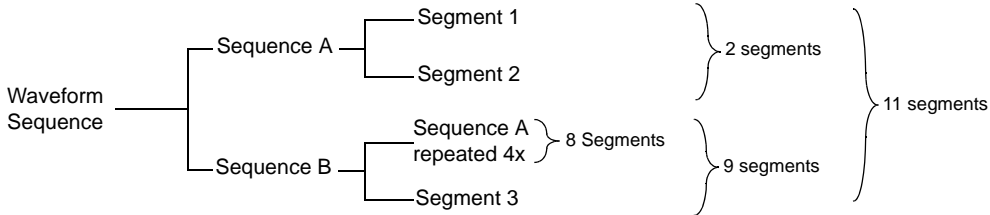

The maximum number of times that a nested sequence can repeat is based on the number of segments in the nested sequence and the remaining number of allowed segments (1,024). For example, with a sequence that contains 24 segments and one nested sequence with 4 segments, the nested sequence is limited to 250 repetitions:

$$24 + (4 \times 250) = 1,024 \text{ maximum number of segments per sequence}$$

Even though there is a limiting factor on the maximum number of times that a nested sequence can repeat, each segment within the nested sequence can repeat up to 65,535 times.

### Example

Use the following procedure to create and store a waveform sequence using one repetition each of two different segments.

*Assumption:* The waveform segments are in BBG media (volatile memory). For information on loading waveform segments into BBG media, see [page 144](#).

1. Select the first segment:
  - a. Press **Mode** > **Dual ARB** > **More** > **Waveform Sequences** > **Build New Waveform Sequence** > **Insert Waveform**.
  - b. Highlight the desired waveform segment and press **Insert**.
2. Select the second segment:
  - a. Highlight the next desired waveform segment and press **Insert**.
  - b. Press **Done Inserting**

3. Name and store the waveform sequence to the Seq file catalog:
  - a. Press **More > Name and Store**.
  - b. Enter a file name and press **Enter**.

See also, “[Viewing the Contents of a Sequence](#)” on page 149 and “[Setting Marker Points in a Waveform Segment](#)” on page 164.

## Viewing the Contents of a Sequence

There are two ways to view the contents of a waveform sequence:

### Through the Waveform Sequences Softkey

1. Press **Mode > Dual ARB > More > Waveform Sequences**.
2. Highlight the desired sequence.
3. Press **Show Waveform Sequence Contents**.

### Using the Select Waveform Softkey

1. Press **Mode > Dual ARB > Select Waveform**.
2. In the Sequence On column, highlight the desired waveform sequence.
3. Press **Show Waveform Sequence Contents**.

## Editing a Sequence

When editing a waveform sequence, you can:

- change the number of times each segment or nested sequence plays
- delete segments or nested sequences from the sequence
- add segments or nested sequences to the sequence
- toggle markers on and off (described on [page 170](#))
- save changes either to the current waveform sequence or as a new sequence

If you exit the sequence editing menu before saving changes, the changes are lost.

Sequences save to the Seq file catalog.

---

**CAUTION** If you edit and resave a segment used in a sequence, the sequence does not automatically update the RMS value in its header. You must select and update the sequence header information ([page 151](#)).

---

Use the following steps to edit a sequence that has two different segments so that the first segment repeats 100 times and the second segment repeats 200 times, then save the changes.

*Assumption:* A waveform sequence that has two different segments has been created and stored (see previous example on [page 148](#)).

1. Select the sequence:  
Press **Mode > Dual ARB > More > Waveform Sequences > *highlight the desired sequence* > Edit Selected Waveform Sequence**.

2. Change the first segment so that it repeats 100 times:  
Highlight the first segment entry and press **Edit Repetitions > 100 > Enter**.

The cursor moves to the next entry.

3. Change the repetition for the selected entry to 200:  
Press **Edit Repetitions > 200 > Enter**.

4. Save the changes made in the previous steps:  
Press **More > Name and Store > Enter**.

To save the changes as a *new* sequence:

- a. Press **More > Name and Store > Clear Text**.
- b. Enter a file name (for example, SINE100+RMP200).
- c. Press **Enter**.

The edited sequence saves as a new waveform sequence.

## Playing a Sequence

If you have not created a waveform sequence, refer to “Creating a Sequence” on page 148.

---

**NOTE** To play a waveform segment individually or as part of a waveform sequence, the segment must reside in BBG media. See also, “Loading a Waveform Segment into BBG Media” on page 144.

---

1. Select a waveform sequence:
  - a. Press **Mode > Dual ARB > Select Waveform**.
  - b. Highlight a waveform sequence (for this example, SINE100+RMP200) from the Sequence On column.
  - c. Press **Select Waveform**.

The display shows the currently selected waveform (for example, Selected Waveform: SEQ:SINE100+RMP200).

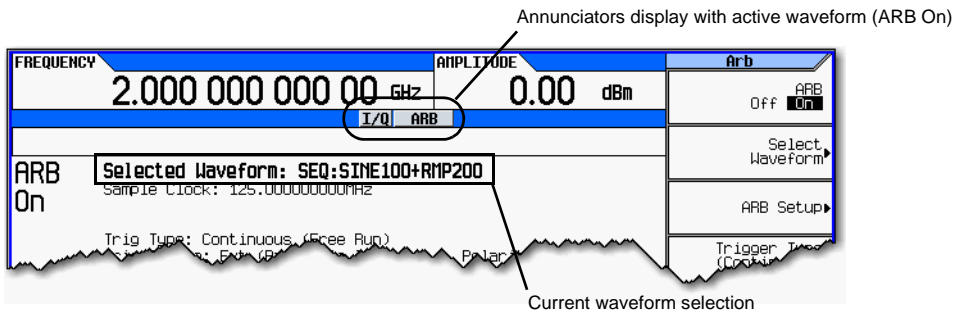

2. Generate the waveform:  
Press **ARB Off On** to On.

This plays the selected waveform sequence. During the waveform sequence generation, both the I/Q and ARB annunciators turn on, and the waveform modulates the RF carrier.

3. Configure the RF output:
  - a. Set the RF carrier frequency.
  - b. Set the RF output amplitude.
  - c. Turn on the RF output.

The waveform sequence is now available at the signal generator's RF OUTPUT connector.

## Saving a Waveform's Settings & Parameters

This section describes how to edit and save a file header. When you download only a waveform file (I/Q data, which the signal generator treats as a waveform segment), the signal generator automatically generates a file header and a marker file with the same name as the waveform file. Initially the file header has no signal generator settings saved to it, and the marker file consists of all zeros. For a given waveform, you can save signal generator settings and parameters in its file header and marker settings in its marker file ([page 157](#)); when you load a stored waveform file into BBG media, the file header and marker file settings automatically apply to the signal generator so that the dual ARB player sets up the same way each time the waveform file plays.

**Figure 8-4 Header Utilities Softkeys**

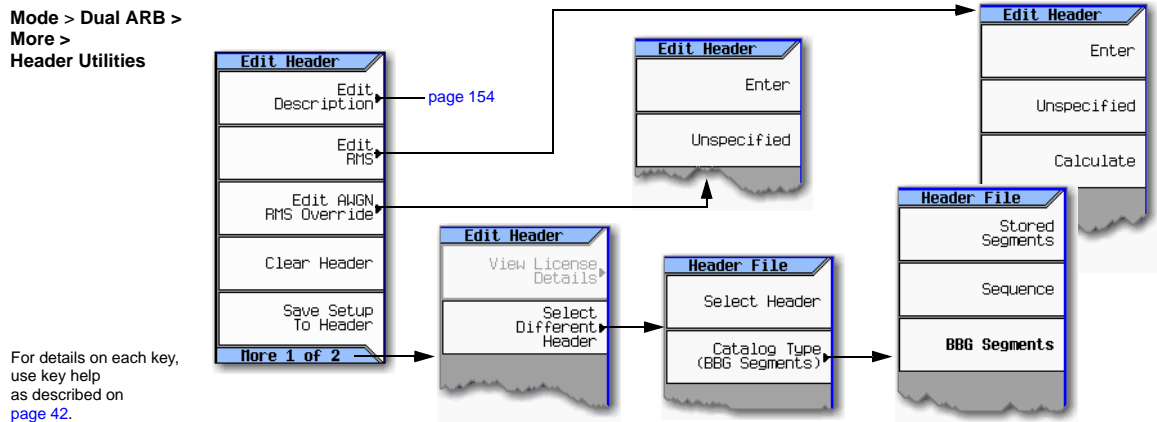

When you create a waveform sequence (as described on [page 148](#)), the signal generator automatically creates a waveform sequence header that takes priority over the individual waveform segment headers. During a waveform sequence playback, the segment headers are ignored, except to verify that all required options are installed. Storing a waveform sequence also stores its file header.

Some of the current signal generator settings shown in the file header appear as part of the softkey labels, and others appear in the dual ARB summary display, shown in the following example.

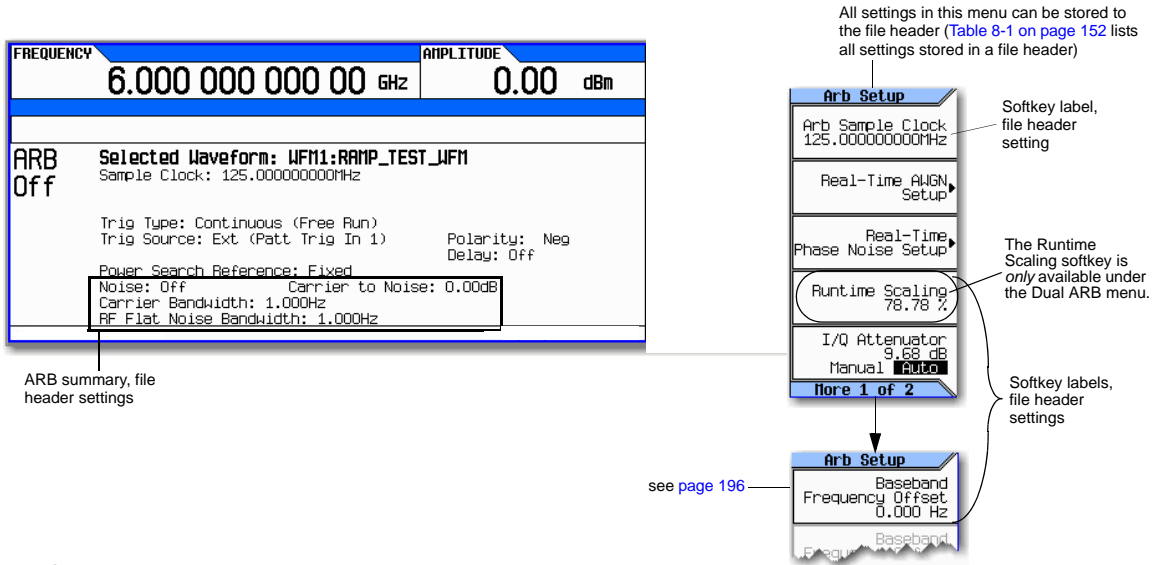

**Table 8-1 File Header Entries**

32-Character Description	A description entered for the header, such as a the waveform's function (saved/edited with the <b>Edit Description</b> softkey, see Figure 8-4).
<b>Sample Rate</b>	The waveform playback rate. This is the ARB sample clock rate, set in the Arb Setup menu (shown in Figure 8-1 on page 143).
<b>Runtime Scaling</b>	The Runtime scaling value is applied in real-time while the waveform is playing. This setting can be changed only for files playing in the dual ARB player (see page 193).
<b>RMS</b>	When the modulator attenuation setting (see page 143) is set to Auto, this value is used to calculate the I/Q modulator attenuation setting to optimize ACPR. Value: 0 to 1.414213562
<b>Marker 1...4 Polarity</b>	Marker polarity can be positive or negative (described on page 170).
<b>ALC Hold Routing</b>	Which marker, if any, implements the ALC hold function (described on page 159), which holds the ALC at its current level when the marker signal is low. All waveforms generated in the signal generator have a marker on the first sample point. To see the results from the three routing selections, you may need to select a range of sample (marker) points (see "Setting Marker Points in a Waveform Segment" on page 164).
<b>RF Blank Routing</b>	Which marker, if any, implements the RF blanking function (described on page 168) when the marker signal is low. RF blanking also uses ALC hold. There is no need to select the ALC Hold Routing for the same marker when you are using the RF Blank Routing function. When the marker signal goes high, RF blanking discontinues.
<b>Mod Attenuation</b>	The I/Q modulator attenuation setting (set in the Arb Setup menu shown in Figure 8-1 on page 143).
<b>BB Freq Offset</b>	The baseband frequency offset, in Hz (see page 196).
<b>AWGN: State</b>	Indicated whether real-time noise is on (1) or off (0) (see page 251).

**Table 8-1 File Header Entries (Continued)**

<b>AWGN: C/N Ratio</b>	Carrier to noise ration, in dB (see <a href="#">page 256</a> ).
<b>AWGN: Carrier BW</b>	Bandwidth over which the noise power is integrated, in Hz (see <a href="#">page 256</a> ).
<b>AWGN: Noise BW</b>	Bandwidth of the noise, in Hz (see <a href="#">page 256</a> ).
<b>AWGN: Carrier RMS</b>	The carrier RMS across the carrier bandwidth (see <a href="#">page 256</a> ).
<b>Phase Noise State</b>	Indicated whether phase noise is on (1) or off (0) (see <a href="#">page 260</a> ).
<b>Phase Noise F1</b>	The start frequency for the level mid-frequency characteristics (see <a href="#">page 260</a> ).
<b>Phase Noise F2</b>	The end frequency for the level mid-frequency characteristics (see <a href="#">page 260</a> ).
<b>Phase Noise Lmid</b>	The amplitude for the level mid-frequency characteristics (see <a href="#">page 260</a> ).
<b>Modulation Filter</b>	The real-time modulation filter type selected (see <a href="#">page 219</a> ).
<b>Over-Range Protect</b>	Indicated whether DAC Over-Range Protection is on (1) or off (0) (see <a href="#">page 264</a> ).
<b>Unique Waveform Id</b>	0 = no Id; once an Id is assigned, it cannot be changed.
<b>License Required</b>	Indicates whether a license is required to play the waveform. See also: " <a href="#">Viewing Options and Licenses</a> " on <a href="#">page 38</a>
<b>Can be Read Out</b>	Indicates whether the waveform can be queried through SCPI or FTP.

## Viewing and Modifying Header Information

The following example uses the factory-supplied waveform file RAMP\_TEST\_WFM.

1. From BBG media, select the waveform RAMP\_TEST\_WFM:
  - a. Press **Mode > Dual ARB > Select Waveform**.
  - b. In the Segment On column, highlight the waveform RAMP\_TEST\_WFM.
  - c. Press **Select Waveform**.
2. Open the Header Utilities menu:

Press **More > Header Utilities**

The [Figure 8-5](#) shows the default file header for the factory-supplied waveform RAMP\_TEST\_WFM. The Header Field column lists the file header parameters; use the **Page Down** key to see them all.

The Saved Header Settings column shows that most of the settings are Unspecified. Unspecified means that there is no setting saved for that particular parameter.

The Current Inst. Settings column shows the current signal generator settings. In this example, these are the settings that you will save to the file header.

---

**NOTE** If a setting is unspecified in the file header, the signal generator uses its current value for that setting when you select and play the waveform.

---

Figure 8-5 Example File Header

Mode > Dual ARB > More > Header Utilities

The name of the waveform file.

The description can be up to 32-characters.

Opens a menu for manually defining the carrier RMS value to use for calculating the AWGN: Carrier RMS value in the Header Field.

Resets the saved header settings entries to default settings

Default header settings

Current signal generator settings

To calculate the RMS waveform voltage:  
 Press **Calculate**  
 Then refer to Header Field information.

Note: For greater accuracy, if the waveform has long rise/fall times, a DC offset, or noise\* already added to the waveform (for a bursted signal), it is recommended that the Edit RMS and Edit AWGN RMS Override softkeys are used for the best measurement accuracy.

\*Option 403 Real-time AWGN does *not* affect the Header Field RMS value. But, noise added to the waveform prior to downloading and playing in the signal generator does affect the Header Field RMS value.

3. Save the information in the Current Inst. Settings column to the file header:

Press **Save Setup To Header**.

Both the Saved Header Settings column and the Current Inst. Settings column now display the same values; the Saved Header Settings column lists the settings saved in the file header.

4. Edit and Update Settings

- a. Return to the ARB Setup menu:  
 Press **Return > More > ARB Setup**.

From this menu you can access some of the signal generator settings that are saved to the file header. [Figure 8-1 on page 143](#) shows the ARB Setup softkeys used in the following steps.

- b. Set the ARB sample clock to 5 MHz:  
 Press **ARB Sample Clock > 5 > MHz**.
- c. Set waveform runtime scaling to 60%:  
 Press **Waveform Runtime Scaling > 60 > %**.
- d. Return to the Header Utilities menu:  
 Press **Return > More > Header Utilities**.

As shown in the following figure, the Current Inst. Settings column now reflects the changes to the current signal generator setup, but the *saved* header values have not changed.



Header Field	Saved Header Settings	Current Inst. Settings
Sample Rate	125.000000000MHz	5.000000000MHz
Runtime Scaling	78.78 %	60.00 %
RMS	0.814852207	N/A
Marker 1 Polarity	Pos	Pos
Marker 2 Polarity	Pos	Pos
Marker 3 Polarity	Pos	Pos
Marker 4 Polarity	Pos	Pos
ALC Hold Routing	None	None

- e. Save the current settings to the file header:  
Press the **Save Setup To Header** softkey.

The settings from the Current Inst. Settings column now appear in the Saved Header Settings column. This saves the new current instrument settings to the file header.

If you change any of the signal generator settings listed in the file header after you select the waveform file, the changed setting(s) appear in the file header's Current Inst. Settings column and are used instead of the saved header settings. To reapply the saved header settings, reselect the waveform for playback.

### Viewing & Editing a Header without Selecting the Waveform

As described on [page 153](#), you can view and edit a waveform's header information after you select the waveform; you can also edit waveform header information without selecting a waveform, or for another waveform than the one that is currently selected.

1. Access the file header utilities menu:  
Press **Mode > Dual ARB > More > Header Utilities > More > Select Different Header**.

The signal generator displays an alphabetical list of the waveform files in the media that was last selected. The following figure shows an example of the factory-supplied waveforms in BBG media.

Active catalog

Active media

Active waveform catalog

Header File

Select Header

Catalog Type (BBG Segments)

4kB used 256MB free

File Name	Type	Size	Modified
1 RAMP_TEST_WFM	WFM1	800	--/--/-- --:--
2 SINE_TEST_WFM	WFM1	800	--/--/-- --:--

Type:

WFM1 = Volatile Segment  
 NVWFM = Non-Volatile Segment  
 SEQ = Sequence

Header File

Stored Segments

Sequence

BBG Segments

Catalogs that enable you to view files in the active media. For details on selecting the active media, see page 64.

Files in BBG media

For details on each key, use key help as described on page 42.

- If the desired catalog is not displayed, select it.
- Highlight the desired waveform file and press **Select Header**.  
 The signal generator displays the file header for the selected waveform file.
- To edit the header, press **More**, and proceed as described in [Step 4 on page 154 \(Viewing and Modifying Header Information section\)](#).

## Using Waveform Markers

The signal generator provides four waveform markers to mark specific points on a waveform *segment*. When the signal generator encounters an enabled marker, an auxiliary signal is routed to a rear panel event output that corresponds to the marker number.

- Event 1 is available at both the EVENT 1 BNC connector (see [page 19](#)), and a pin on the AUXILIARY I/O connector (see [page 20](#)).
- Event 2 is available at both the TRIG OUT BNC connector (see [page 16](#)), and a pin on the AUXILIARY I/O connector (see [page 20](#)).
- Events 3 and 4 are available at pins on the AUXILIARY I/O connector (see [page 20](#)).

You can use an auxiliary output signal to synchronize another instrument with the waveform, or as a trigger signal to start a measurement at a given point on a waveform.

You can also configure markers to initiate ALC hold or RF Blanking (which includes ALC hold). Refer to “Using Waveform Markers” on [page 157](#) for details.

When you download a waveform file that does not have a marker file associated with it, the signal generator creates a marker file without any marker points. Factory-supplied segments (RAMP\_TEST\_WFM and SINE\_TEST\_WFM) have a marker point on the first sample for all four markers.

The following procedures demonstrate how to use markers while working in the dual ARB player. These procedures also discuss two types of points: a *marker point* and a *sample point*. A marker point is a point at which a given marker is set on a waveform; you can set one or more marker points for each marker. A *sample point* is one of the many points that compose a waveform.

There are three basic steps to using waveform markers:

[Clearing Marker Points from a Waveform Segment](#) on [page 163](#)

[Setting Marker Points in a Waveform Segment](#) on [page 164](#)

[Controlling Markers in a Waveform Sequence](#) on [page 170](#)

This section also provides the following information:

- [Waveform Marker Concepts](#) on [page 158](#)
- [Accessing Marker Utilities](#) on [page 162](#)
- [Viewing Waveform Segment Markers](#) on [page 163](#)
- [Viewing a Marker Pulse](#) on [page 167](#)
- [Using the RF Blanking Marker Function](#) on [page 168](#)
- [Setting Marker Polarity](#) on [page 170](#)

## Waveform Marker Concepts

The signal generator's Dual ARB provides four waveform markers for use on a waveform segment. You can set each marker's polarity and marker points (on a single sample point or over a range of sample points). Each marker can also perform ALC hold, or RF Blanking and ALC hold.

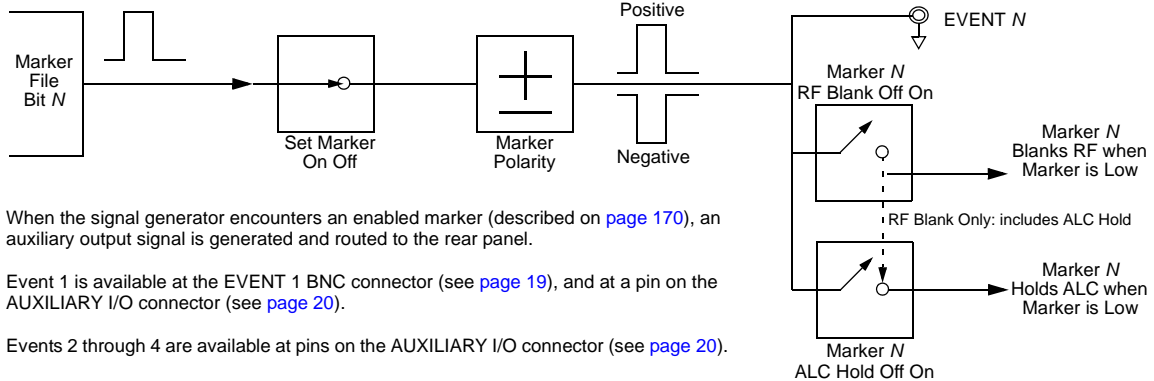

## Marker Signal Response

The signal generator aligns the marker signals with the I and Q signals at the baseband generator. However some settings such as amplitude, filters, and so forth within the RF output path can create delays between the marker EVENT output signal and the modulated RF output. When using the marker EVENT output signal, observe the signals (marker relative to modulated RF) for any latency, and if needed, reset the marker point positions, include delay ([page 203](#)), or both.

## Marker File Generation

Downloading a waveform file (as described in the *Programming Guide*) that does not have a marker file associated with it causes the signal generator to automatically create a marker file, but does *not* place any marker points.

## Marker Point Edit Requirements

Before you can modify a waveform segment's marker points, the segment must reside in BBG media (see "Loading a Waveform Segment into BBG Media" on [page 144](#)).

## Saving Marker Polarity and Routing Settings

Marker polarity and routing settings remain until you reconfigure them, preset the signal generator, or cycle power. To ensure that a waveform uses the correct settings when it is played, set the marker polarities or routing (RF Blanking and ALC Hold) and save the information to the file header ([page 151](#)).

---

**NOTE** When you use a waveform that does **NOT** have marker routings and polarity settings stored in the file header, and the previously played waveform used RF Blanking, ensure that you set RF Blanking to **None**. Failure to do so can result in no RF output or a distorted waveform.

---

### ALC Hold Marker Function

While you can set a marker function (described as **Marker Routing** on the softkey label) either before or after you set marker points ([page 164](#)), setting a marker function before setting marker points may cause power spikes or loss of power at the RF output.

Use the ALC hold function by itself when you have a waveform signal that incorporates idle periods, burst ramps, or when the increased dynamic range encountered with RF blanking ([page 168](#)) is not desired.

The ALC hold marker function holds the ALC circuitry at the *average* value of the sampled points set by the marker(s). For both positive and negative marker polarity, the ALC samples the RF output signal (the carrier plus any modulating signal) when the marker signal goes high:

- Positive: The signal is sampled during the on marker points.
- Negative: The signal is sampled during the off marker points.

---

**NOTE** Because it can affect the waveform's output amplitude, do not use the ALC hold for longer than 100 ms. For longer time intervals, refer to "[Power Search Mode](#)" on [page 111](#).

---

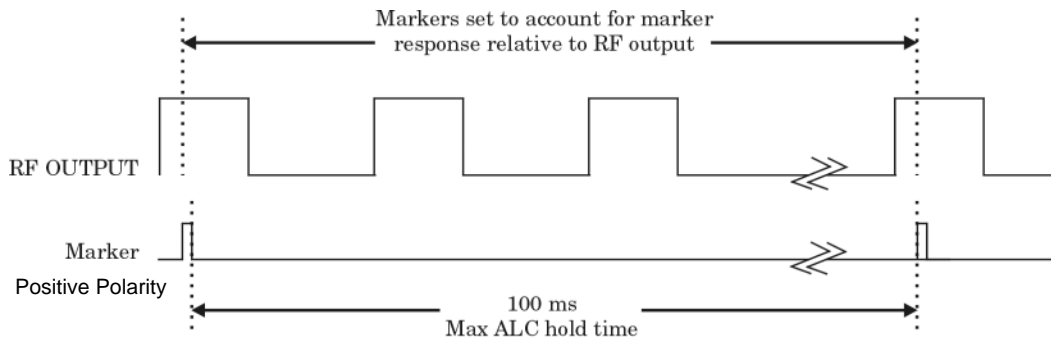

---

**CAUTION** Incorrect ALC sampling can create a sudden unlevelled condition that may create a spike in the RF output, potentially damaging a DUT or connected instrument. To prevent this condition, ensure that you set markers to let the ALC sample over an amplitude that accounts for the higher power levels encountered within the signal.

---

### Example of Correct Use

Waveform: 1022 points  
Marker range: 95–97  
Marker polarity: Positive

This example shows a marker set to sample the waveform's area of highest amplitude. Note that the marker is set well before the waveform's area of lowest amplitude. This takes into account any response difference between the marker and the waveform signal.

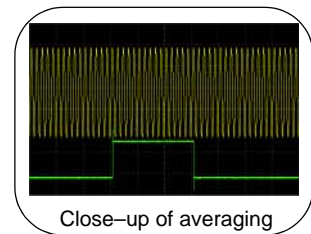
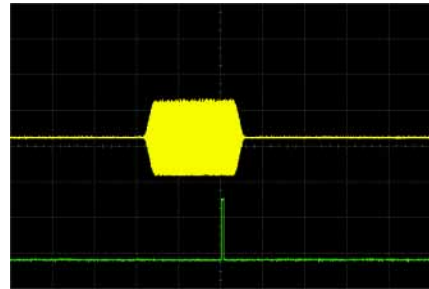

The ALC samples the waveform when the marker signal goes high, and uses the average of the sampled waveform to set the ALC circuitry.

Here the ALC samples during the *on* marker points (positive polarity).

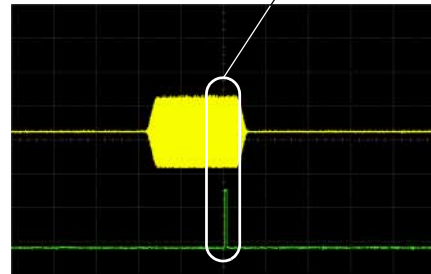

### Example of Incorrect Use

Waveform: 1022 points  
Marker range: 110–1022  
Marker polarity: Positive

This example shows a marker set to sample the low part of the same waveform, which sets the ALC modulator circuitry for that level; this usually results in an unlevelled condition for the signal generator when it encounters the high amplitude of the pulse.

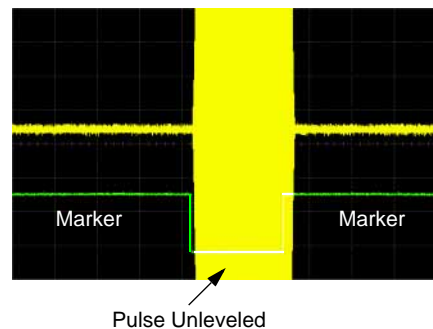

### Example of Incorrect Use

Waveform: 1022 points

Marker range: 110–1022

Marker polarity: Negative

This figure shows that a negative polarity marker goes low during the marker *on* points; the marker signal goes high during the *off* points. The ALC samples the waveform during the *off* marker points.

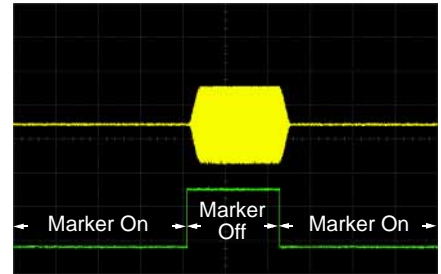

Sample range begins on first point of signal

Sampling both on and off time sets the modulator circuitry incorrectly for higher signal levels. Note the increased amplitude at the beginning of the pulse.

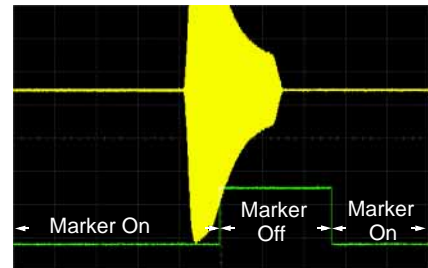

Negative range set between signal and off time

## Accessing Marker Utilities

Mode > Dual ARB > More > Marker Utilities

For details on each key, use key help as described on [page 42](#).

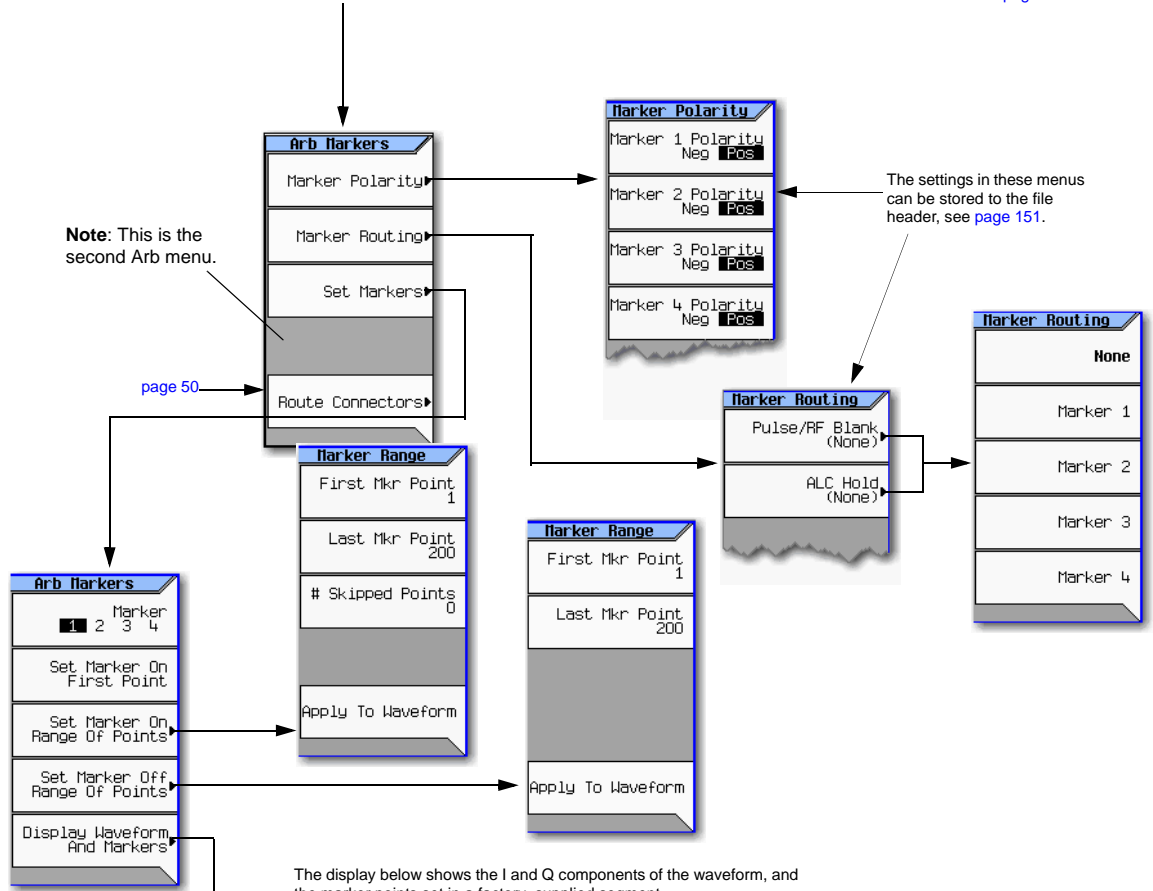

Note: This is the second Arb menu.

page 50

The display below shows the I and Q components of the waveform, and the marker points set in a factory-supplied segment.

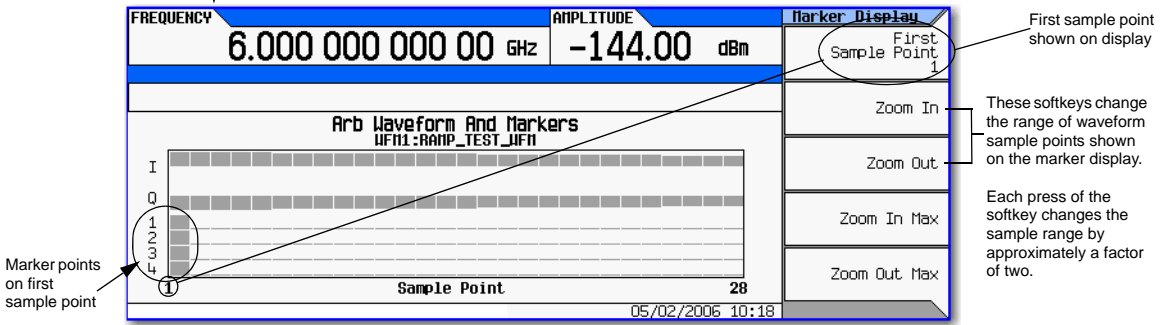



## Viewing Waveform Segment Markers

Markers are applied to waveform segments. Use the following steps to view the markers set for a segment (this example uses the factory-supplied segment, SINE\_TEST\_WFM).

1. In the second Arb menu (page 162), press **Marker Utilities > Set Markers**.
2. Highlight the desired waveform segment (in this example, SINE\_TEST\_WFM).
3. Press **Display Waveform and Markers > Zoom in Max**.  
The maximum zoom in range is 28 points.

Experiment with the Zoom functions to see how they display the markers.

The display can show a maximum of 460 points; displayed waveforms with a sample point range greater than 460 points may not show the marker locations.

## Clearing Marker Points from a Waveform Segment

When you set marker points they do not replace points that already exist, but are set *in addition* to existing points. Because markers are cumulative, before you set points, view the segment (page 163) and remove any unwanted points. With all markers cleared, the level of the event output signal is 0V. To clear marker points on a segment, the segment must reside in BBG media (page 144).

### Clearing All Marker Points

1. In the second Arb menu (page 162), press **Marker Utilities > Set Markers**.
2. Highlight the desired waveform segment (in this example, SINE\_TEST\_WFM).
3. Highlight the desired marker number: Press **Marker 1 2 3 4**.
4. For the selected marker number, remove all marker points in the selected segment:
  - a. Press **Set Marker Off Range of Points**.  
Notice that the softkeys for the first and last marker points correspond with the length of the waveform. The factory-supplied waveform (SINE\_TEST\_WFM) contains 200 samples. To clear all set marker points, the range must equal to the length of the waveform.
  - b. Press **Apply To Waveform > Return**.
5. Repeat from Step 3 for any remaining marker points that you want to remove from the other markers.

### Clearing a Range of Marker Points

The following example uses a waveform with marker points (Marker 1) set across points 10–20. This makes it easy to see the affected marker points. The same process applies whether the existing points are set over a range or as a single point (page 164).

1. In the second Arb menu (page 162), press **Marker Utilities > Set Markers**, then select Marker 1.
2. Set the first sample point that you want off (for this example, 13):  
Press **Set Marker Off Range Of Points > First Mkr Point > 13 > Enter**.
3. Set the last marker point in the range that you want off to a value less than or equal to the number of points in the waveform, *and* greater than or equal to the value set in Step 2 (for this example, 17):

Press **Last Mkr Point > 17 > Enter > Apply To Waveform > Return.**

This turns off all marker points for the active marker within the range set in [Steps 2 and 3](#), as shown at right.

How to view markers is described on [page 163](#).

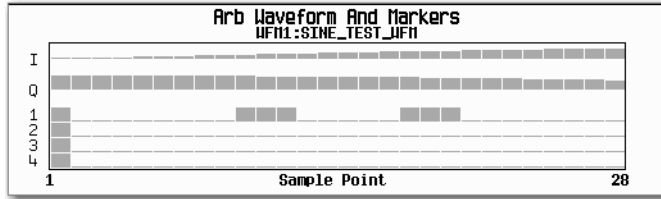

### Clearing a Single Marker Point

Use the steps described in “[Clearing a Range of Marker Points](#)” on [page 163](#), but set both the first and last marker point to the value of the point you want to clear. For example, if you want to clear a marker on point 5, set both the first and last value to 5.

### Setting Marker Points in a Waveform Segment

To set marker points on a segment, the segment must reside in BBG media ([page 144](#)).

When you set marker points, they do not replace points that already exist, but are set *in addition* to existing points. Because markers are cumulative, before you set marker points within a segment, view the segment ([page 163](#)) and remove any unwanted points ([page 163](#)).

### Placing a Marker Across a Range of Points

1. In the second Arb menu ([page 162](#)), press **Marker Utilities > Set Markers**.
2. Highlight the desired waveform segment.
3. Select the desired marker number: Press **Marker 1 2 3 4**
4. Set the first sample point in the range (in this example, 10):  
Press **Set Marker On Range Of Points > First Mkr Point > 10 > Enter.**
5. Set the last marker point in the range to a value less than or equal to the number of points in the waveform, *and* greater than or equal to the first marker point (in this example, 20):  
Press **Last Mkr Point > 20 > Enter.**
6. Press **Apply To Waveform > Return.**

This sets a range of waveform marker points. The marker signal starts on sample point 10, and ends on sample point 20, as shown in the following figure.

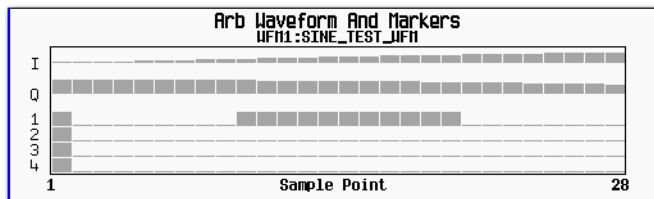

How to view markers is described on

### Placing a Marker on a Single Point

#### *On the First Point*

1. In the second Arb menu ([page 162](#)), press **Marker Utilities > Set Markers**.
2. Highlight the desired waveform segment.
3. Select the desired marker number:  
Press **Marker 1 2 3 4**.
4. Press **Set Marker On First Point**.

This sets a marker on the first point in the segment for the marker number selected in [Step 3](#).

#### *On Any Point*

Use the steps described in [“Placing a Marker Across a Range of Points” on page 164](#), but set both the first and last marker point to the value of the point you want to set. For example, if you want to set a marker on point 5, set both the first and last value to 5.

### Placing Repetitively Spaced Markers

The following example sets markers across a range of points and specifies the spacing (skipped points) between each marker. You must set the spacing *before* you apply the marker settings; you cannot apply skipped points to a previously set range of points.

---

**NOTE** The skipped points value is limited to the size of the range of points.

---

1. Remove any existing marker points ([page 158](#)).
2. In the second Arb menu ([page 162](#)), press **Marker Utilities > Set Markers**.
3. Highlight the desired waveform segment.
4. Select the desired marker number:  
Press **Marker 1 2 3 4**.
5. Set the first sample point in the range (in this example, 5):  
Press **Set Marker On Range Of Points > First Mkr Point > 5 > Enter**.
6. Set the last marker point in the range. (The last marker point value must always be less than or equal to the number of points in the waveform, *and* greater than or equal to the first marker point, in this example, 25):  
Press **Last Mkr Point > 25 > Enter**.
7. Enter the number of sample points that you want skipped (in this example, 1):  
Press **# Skipped Points > 1 > Enter**.
8. Press **Apply To Waveform > Return**.

This causes the marker to occur on every other point (one sample point is skipped) within the marker point range, as shown at right.

How to view markers is described on [page 163](#).

One application of the skipped point feature is the creation of a clock signal as the EVENT output.

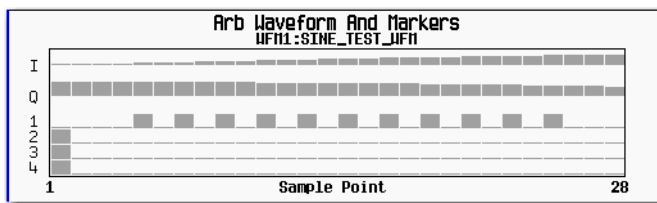

## Viewing a Marker Pulse

When a waveform plays (page 150), you can detect a set and enabled marker's pulse at the rear panel event connector/Aux I/O pin that corresponds to that marker number. This example demonstrates how to view a marker pulse generated by a waveform segment that has at least one marker point set (page 164). The process is the same for a waveform sequence.

This example uses the factory-supplied segment, SINE\_TEST\_WFM in the dual ARB Player. Factory-supplied segments have a marker point on the first sample point for all four markers, as shown.

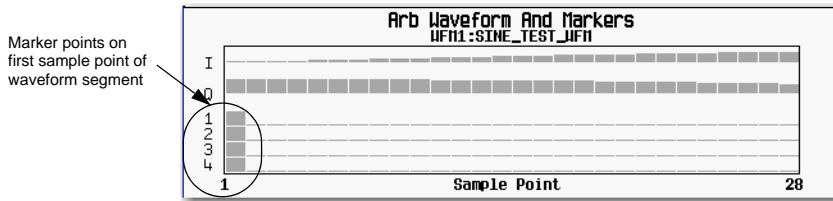

How to view markers is described on page 163

1. In the first Arb menu (page 143), press **Select Waveform**.
2. Highlight the SINE\_TEST\_WFM segment and press **Select Waveform**.
3. Press **ARB Off On** to On.
4. Connect the Agilent MXG's rear panel Q OUT output to the oscilloscope's channel 1 input.
5. Connect the signal generator's rear panel EVENT 1 output to the oscilloscope's channel 2 input.

When marker 1 is present, the Agilent MXG outputs a signal through EVENT 1 as shown in the following example.

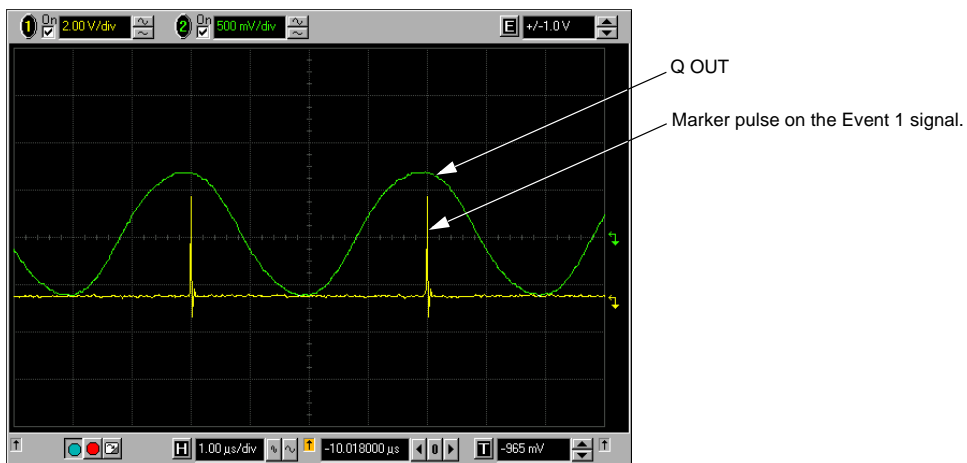

## Using the RF Blanking Marker Function

While you can set a marker function (described as **Marker Routing** on the softkey label in the Marker Utilities menu) either before or after setting the marker points (page 164), setting a marker function before you set marker points may change the RF output. RF Blanking includes ALC hold (described on page 159, note **Caution** regarding unlevelled power). The signal generator blanks the RF output when the marker signal goes low. This example is a continuation of the previous example, [Viewing a Marker Pulse](#).

1. Using the factory-supplied segment SINE\_TEST\_WFM, set Marker 1 across points 1–180 (page 164).
2. From the **Marker Routing** softkey menu, assign RF Blanking to Marker 1:  
In the second Arb menu (page 162), press **Marker Utilities** > **Marker Routing** > **Pulse/RF Blank** > **Marker 1**.

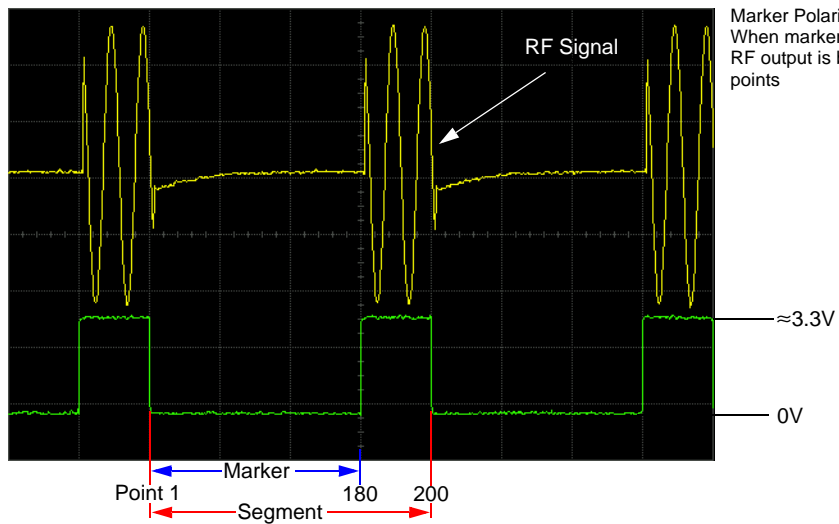
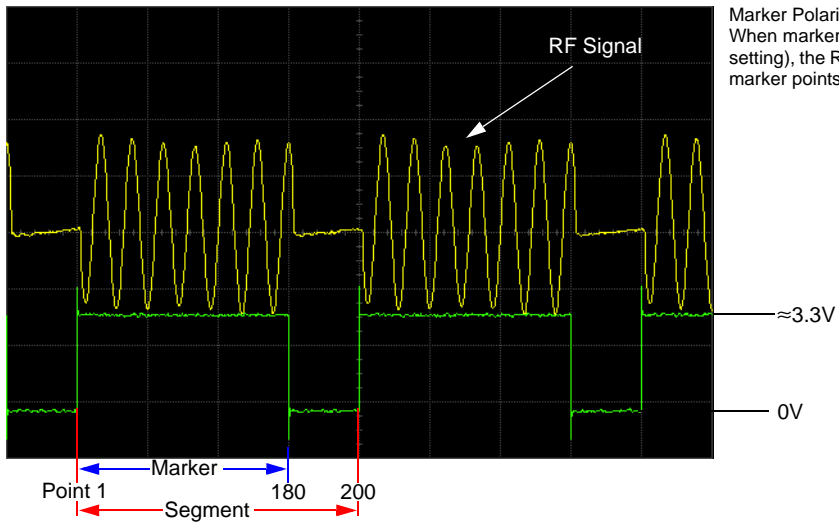

## Setting Marker Polarity

Setting a negative marker polarity inverts the marker signal.

1. In second Arb menu ([page 162](#)), press **Marker Utilities > Marker Polarity**.
2. For each marker, set the marker polarity as desired.
  - The default marker polarity is positive.
  - Each marker polarity is set independently.

See also, “[Saving Marker Polarity and Routing Settings](#)” on [page 158](#).

As shown on [page 168](#):

Positive Polarity: *On* marker points are high ( $\approx 3.3V$ ).

Negative Polarity: *On* marker points are low (0V).

RF blanking always occurs on the low part of the signal regardless of the polarity setting.

## Controlling Markers in a Waveform Sequence

In a waveform segment, an enabled marker point generates an auxiliary output signal that is routed to the rear panel EVENT output (described in “[Rear Panel Overview – N5161A/62A<sup>1</sup>/81A/82A MXG](#)” on [page 15](#)) corresponding to that marker number. For a waveform sequence, you enable or disable markers on a segment-by-segment basis; this enables you to output markers for some segments in a sequence, but not for others. Unless you change the sequence marker settings or cycle the power, the marker setting for the last segment edited in the sequence applies to all segments in the next sequence that you build. For information on building a waveform sequence, see “[Creating a Sequence](#)” on [page 148](#).



**Figure 8-6 Waveform Sequence Menus for Enabling/Disabling Segment Markers**

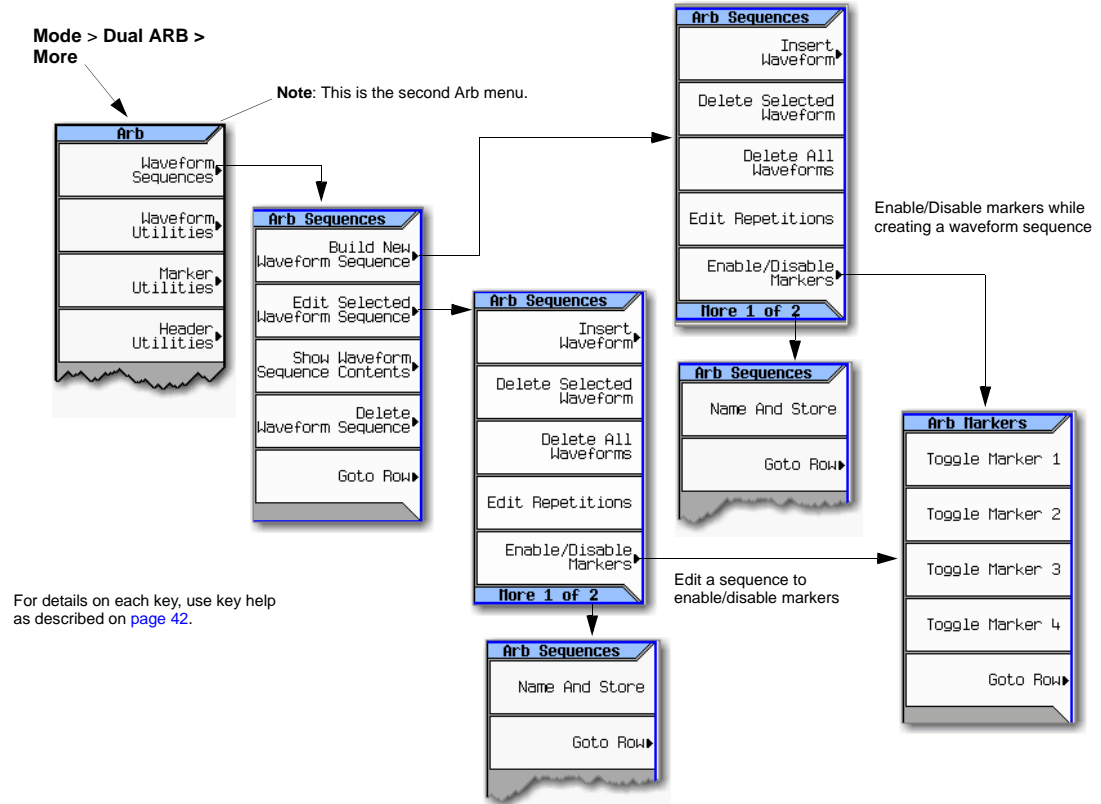

### Enabling and Disabling Markers in a Waveform Sequence

Select the waveform segments within a waveform sequence to enable or disable each segment’s markers independently. You can enable or disable the markers either at the time of creating the sequence or after the sequence has been created and stored. If the sequence has already been stored, you must store the sequence again after making any changes. Enabling a marker that has no marker points has no effect on the auxiliary outputs. To set marker points on a segment, see “Setting Marker Points in a Waveform Segment” on page 164. This example assumes that a waveform sequence exists.

1. Ensure that all waveform segments for the sequence reside in BBG media (see page 144).
2. From the second Arb menu, press **Waveform Sequences**.
3. Highlight the desired waveform sequence.
4. Press **Edit Selected Waveform Sequence > Enable/Disable Markers**.
5. Toggle the markers:
  - a. Highlight the first waveform segment.
  - b. As desired, press **Toggle Marker 1**, **Toggle Marker 2**, **Toggle Marker 3**, and **Toggle Marker 4**.

An entry in the Mkr column (see figure below) indicates that the marker is enabled for that segment; no entry in the column means that all markers are disabled for that segment.

- c. In turn, highlight each of the remaining segments and repeat **Step b**.
6. Press **Return > More > Name and Store**.
7. Either rename the sequence using the text entry keys (see page 145) or just press **Enter** to save the sequence with the existing name.

The markers are enabled or disabled per the selections, and the changes saved to the sequence file.

The following figure shows a sequence built using one of the factory-supplied waveform segments; a factory-supplied segment has a marker point on the first sample for all four markers. In this example, marker 1 is enabled for the first segment, marker 2 is enable for the second segment, and markers 3 and 4 are enabled for the third segment.

Segment On BBG Media (1/1)	Sequence On Int. Media	(UNSTORED) (1/1)	Waveform	Reps	UNTITLED /tkr	Mkr
RAMP_TEST_WFM	SEQ1	WF11:SINE_TEST_WFM	1	1		
SINE_TEST_WFM	SINE100+RMP200	WF11:SINE_TEST_WFM	1	2		
		WF11:SINE_TEST_WFM	1	3		34

Toggle Marker 4

Sequence marker column

Toggle Marker 3

This entry shows that markers 3 and 4 are enabled for this segment.

For each segment, only the markers enabled for that segment produce a rear panel auxiliary output signal. In this example, the marker 1 auxiliary signal appears only for the first segment, because it is disabled for the remaining segments. The marker 2 auxiliary signal appears only for the second segment, and the marker 3 and 4 auxiliary signals appear only for the third segment.

## Using the EVENT Output Signal as an Instrument Trigger

One of the uses for the EVENT output signal (marker signal) is to trigger a measurement instrument. You can set up the markers to start the measurement at the beginning of the waveform, at any single point in the waveform, or on multiple points in the waveform. To optimize the use of the EVENT signal for measurements, you may also need to adjust the sample rate. The location of the sample rate setting is shown in the figure at right.

For details on each key, use key help as described on [page 42](#).

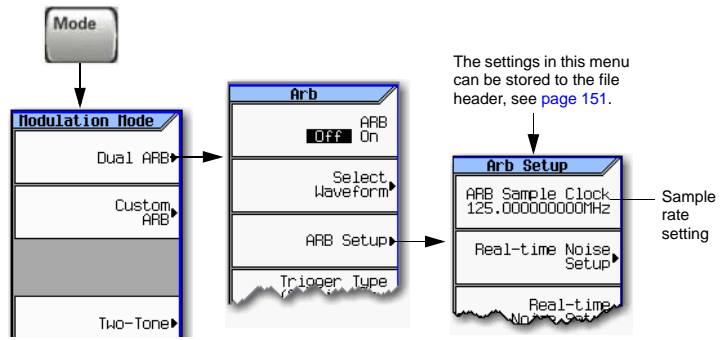

The EVENT output signal can exhibit jitter of up to  $\pm 4$  ns on the rising and falling edge. This jitter can be minimized in either of two ways.

**Method 1:** Use a sample clock of  $125 \text{ MHz}/N$  where  $N$  is a positive integer and where  $125 \text{ MHz}/N$  can be represented exactly on the display.

For example: 125 MHz, 62.5 MHz, 31.25 MHz, 25 MHz, and so on.

If the result cannot be represented exactly on the display, jitter will be present.

For example:  $N = 6$  will result in jitter, because  $125 \text{ MHz}/6 = 20.833 \text{ Mhz}$ , which is truncated when displayed.

**Method 2:** Select a sample clock and waveform length that spaces the markers by a multiple of 8 ns. For example: A 200 point waveform with a marker on the first point and a sample clock of 50 MHz provides a marker every  $4 \mu\text{s}$ . Because  $4 \mu\text{s}$  is a multiple of 8 ns, the jitter is minimized.

When the EVENT output signal exhibits jitter and it is used as a measurement trigger, it can cause the waveform to falsely appear as having jitter. If this condition occurs, you can adjust the sample rate to a value (see above) that does not cause the jitter appearance. To maintain the integrity of the original waveform with a sample rate change, you will have to also recalculate the sample values. The following figures illustrate the marker signal jitter and its affect on the waveform.

EVENT output signal exhibits jitter due to a non-optimal sample rate

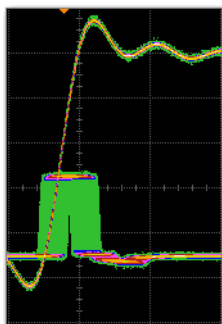

Oscilloscope triggering on waveform

Waveform appears to exhibit jitter when triggered using EVENT signal with jitter.

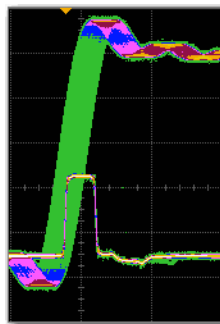

Oscilloscope triggering on EVENT signal

The jitter is gone with an optimal sample rate

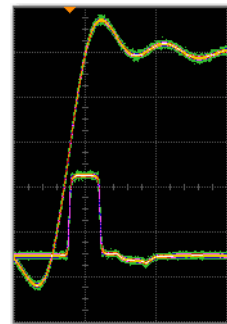

Oscilloscope triggering on EVENT signal

## Triggering a Waveform

Figure 8-7 Triggering Softkeys

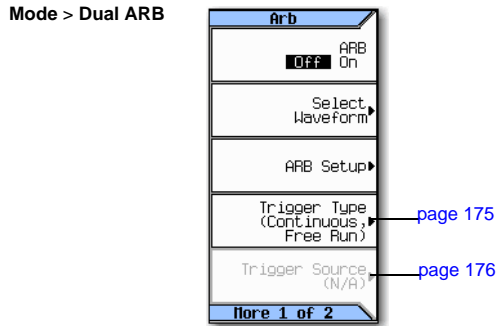

For details on each key, use key help as described on [page 42](#).

Triggers control data transmission by controlling when the signal generator transmits the modulating signal. You can configure trigger settings so that data transmission occurs once (Single mode), continuously (Continuous mode), or starts and stops repeatedly (Gated and Segment Advance modes).

A trigger signal contains both positive and negative states; you can use either for triggering.

When you initially select a trigger mode or when you change from one triggering mode to another, you may lose the carrier signal at the RF output until the modulating signal is triggered. This is because the signal generator sets the I and Q signals to zero volts prior to the first trigger event. To maintain the carrier signal at the RF output, create a data pattern with the initial I and Q voltages set to values other than zero.

When you initially turn the Arb ON or select a trigger mode or when you change from one triggering mode to another, you may temporarily lose the carrier signal for a few tens of milliseconds at the RF output. The Arb will present the idle IQrms value of the next Arb waveform to the IQ modulator. This ensures that the RF carrier output is at the correct amplitude level while the Arb waits for a trigger. When that trigger is received, the Arb begins playing the waveform and the modulated RF carrier exhibits no undesirable transients.

There are two parts to configuring a waveform trigger:

- *Type* determines the behavior of the waveform when it plays (see [Trigger Type](#) on page 175).
- *Source* determines how the signal generator receives the trigger that starts the modulating waveform playing (see [Trigger Source](#) on page 176).

## Trigger Type

Type defines the trigger mode: how the waveform plays when triggered.

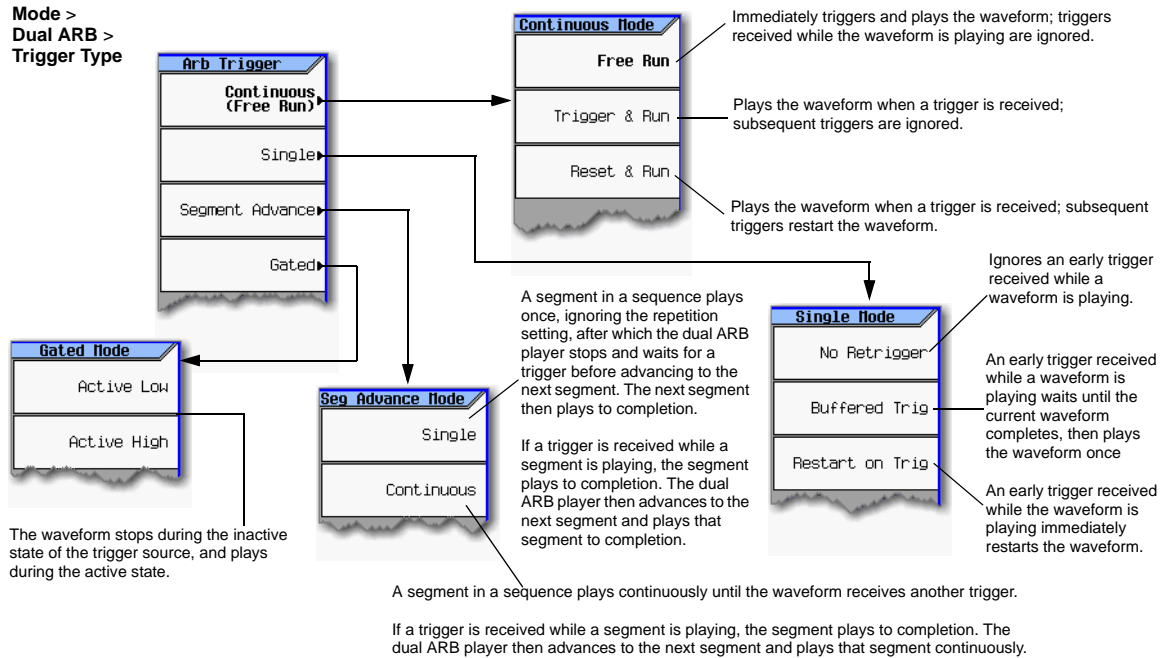

For details on each key, use key help as described on [page 42](#).

- **Continuous** mode repeats the waveform until you turn the signal off or select a different waveform, trigger mode, or response (Free Run, Trigger & Run, Reset & Run).
- **Single** mode plays the waveform once.

**NOTE** In **Single No Retrigger**, do not use **Continuous Reset & Run** mode due to the variable latency of this setup.

**No Retrigger:** If a trigger is received early it will be ignored. The gap in your playback is dependant on the trigger period, after which time the RF will start up again where it is expected.

**Buffered Trigger:** An early trigger will cause the waveform to play to the end and then start again. The RF will not be aligned with this early trigger.

**Restart on Trigger:** The ARB will reset itself and trigger again but there will some gap in the playback while this is occurring. It will reset itself for every trigger it receives.

- **Segment Advance** mode plays a segment in a sequence only if triggered. The *trigger source* controls segment-to-segment playing (see [Example: Segment Advance Triggering](#) on page 177). A trigger received during the last segment loops play to the *first* segment in the sequence.

- **Gated** mode triggers the waveform at the first active triggering state, then repeatedly starts and stops playing the waveform in response to an externally applied gating signal. See [Example: Gated Triggering](#) on page 178.

## Trigger Source

Mode >  
 Dual ARB >  
 Trigger Source

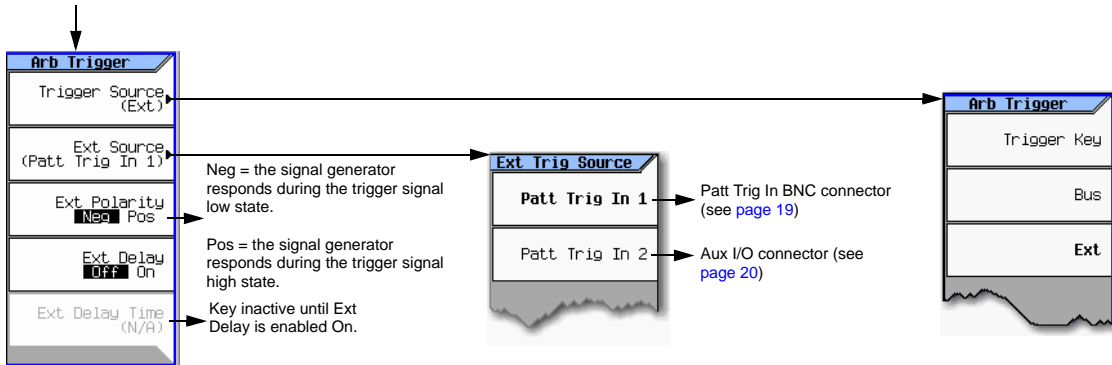

For details on each key, use key help as described on [page 42](#).

## External Trigger Polarity

- In Continuous, Single, and Segment Advance modes, use the **Ext Polarity** softkey to set the external trigger polarity.
- In Gated mode, the **Active Low** and **Active High** softkeys ([page 175](#)) determine the external trigger polarity.

## Example: Segment Advance Triggering

Segment advance triggering enables you to control the segment playback within a waveform sequence. This type of triggering ignores the repetition value (page 149). For example if a segment has repetition value of 50 and you select Single as the segment advance triggering mode, the segment still plays only once. The following example uses a waveform sequence that has two segments.

If you have not created and stored a waveform sequence, refer to “Creating a Sequence” on page 148.

1. Preset the signal generator.
2. Configure the RF output:
  - Set the desired frequency.
  - Set the desired amplitude.
  - Turn on the RF output.
3. Select a waveform sequence for playback:
  - a. Press **Mode > Dual ARB > Select Waveform**.
  - b. In the Sequence On column, highlight a waveform sequence file.
  - c. Press **Select Waveform**.
4. Set the triggering as follows:
  - Trigger Type: continuous Segment Advance  
Press **Trigger Type > Segment Advance > Continuous**.
  - Trigger source: Trigger hardkey  
Press **Trigger Source > Trigger Key**.
5. Generate the waveform sequence:  
Press **ARB Off On** until On highlights.
6. (Optional) Monitor the waveform:  
Connect the RF OUTPUT of the signal generator to the input of an oscilloscope, and configure the oscilloscope so that you can see the signal.
7. Trigger the first waveform segment to begin playing continuously:  
Press the **Trigger** hardkey.
8. Trigger the second segment:  
Press the **Trigger** hardkey.

Pressing the **Trigger** hardkey causes the currently playing segment to finish and the next segment to start.

If the last segment in the sequence is playing, pressing the **Trigger** hardkey causes the *first* segment in the waveform sequence to start when the last segment finishes.

## Example: Gated Triggering

Gated triggering enables you to define the on and off states of a modulating waveform.

1. Connect the output of a function generator to the signal generator's rear panel PAT TRIG IN connector, as shown in the following figure. This connection is applicable to all external triggering methods. The optional oscilloscope connection enables you to see the effect that the trigger signal has on the RF output.

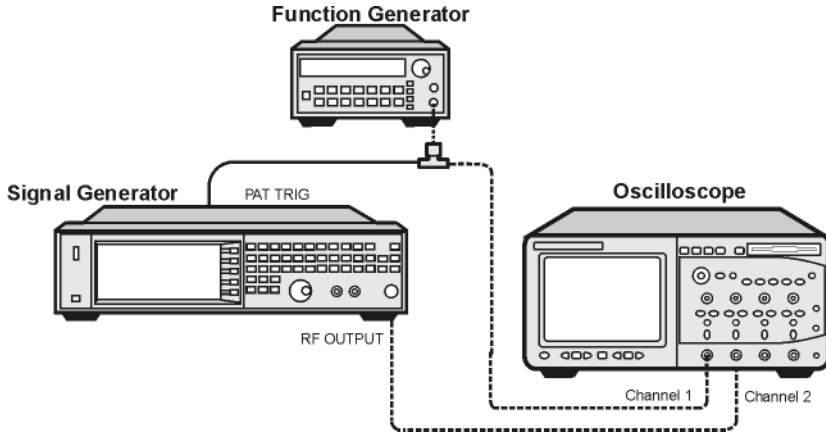

2. Preset the signal generator.
3. Configure the RF output:
  - Set the desired frequency.
  - Set the desired amplitude.
  - Turn on the RF output.
4. Select a waveform for playback (sequence or segment):
  - a. Press **Mode > Dual ARB > Select Waveform**.
  - b. In the Segment On or Sequence On column, highlight a waveform.
  - c. Press **Select Waveform**.
5. Set the triggering as follows:
  - Trigger type: Gated  
Press **Trigger Type > Gated**.
  - Active state: Low  
Press **Active Low**.
  - Trigger source: External  
Press **Trigger Source > Ext**.
  - Input connector: Rear panel Patt Trig In BNC  
Press **Ext Source > Patt Trig In 1**.
6. Generate the waveform: Press **Return > ARB Off On** until On highlights.



7. On the function generator, configure a TTL signal for the external gating trigger.
8. (Optional) Monitor the waveform:

Configure the oscilloscope to display both the output of the signal generator, and the external triggering signal. You will see the waveform modulating the output during the gate *active* periods (low in this example).

The following figure shows an example display.

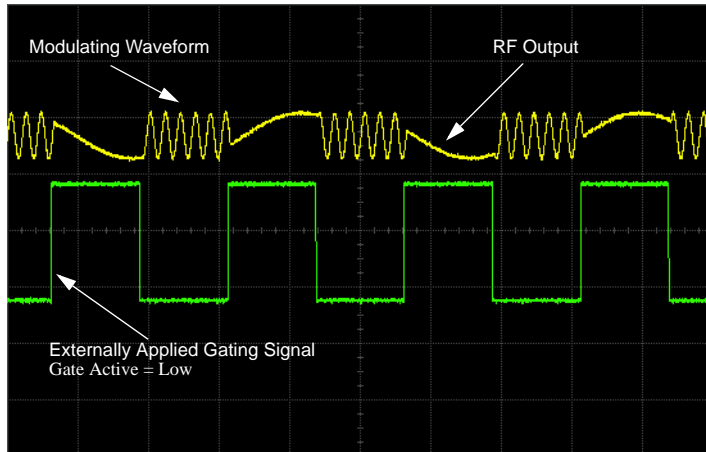

## Example: External Triggering

Use the following example to set the signal generator to output a modulated RF signal 100 milliseconds after a change in TTL state from low to high occurs at the PATT TRIG IN rear panel BNC connector

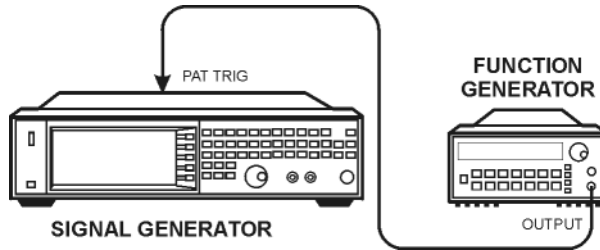

1. Connect the signal generator to the function generator as shown above.
2. Configure the RF output:
  - Set the desired frequency.
  - Set the desired amplitude.
  - Turn on the RF output.
3. Select a waveform for playback (sequence or segment):
  - a. Press **Mode > Dual ARB > Select Waveform**.
  - b. In the Segment On or Sequence On column, highlight a waveform.
  - c. Press **Select Waveform**.
4. Generate the waveform:  
Press **ARB Off On** until On highlights.
5. Set the waveform trigger as follows:
  - a. Trigger Type: single  
Press **Trigger Type > Single > No Retrigger**
  - b. Trigger Source: external  
Press **Trigger Source > Ext**
  - c. Input connector: Rear panel Patt Trig In BNC  
Press **Ext Source > Patt Trig In 1**.
  - d. External Trigger Polarity: positive  
Press **Ext Polarity** until Pos highlights
  - e. External Delay: 100 ms  
Press **More > Ext Delay** until On highlights  
Press **Ext Delay Time > 100 > msec**
6. Configure the Function Generator:
  - Waveform: 0.1 Hz square wave
  - Output Level: 3.5V to 5V.

## Clipping a Waveform

Digitally modulated signals with high power peaks can cause intermodulation distortion, resulting in spectral regrowth that can interfere with signals in adjacent frequency bands. The clipping function enables you to reduce high power peaks by clipping the I and Q data to a selected percentage of its highest peak, thereby reducing spectral regrowth.

- [How Power Peaks Develop](#) on page 182
- [How Peaks Cause Spectral Regrowth](#) on page 184
- [How Clipping Reduces Peak-to-Average Power](#) on page 185
- [Configuring Circular Clipping](#) on page 188
- [Configuring Rectangular Clipping](#) on page 189

**Figure 8-8 Clipping Softkeys**

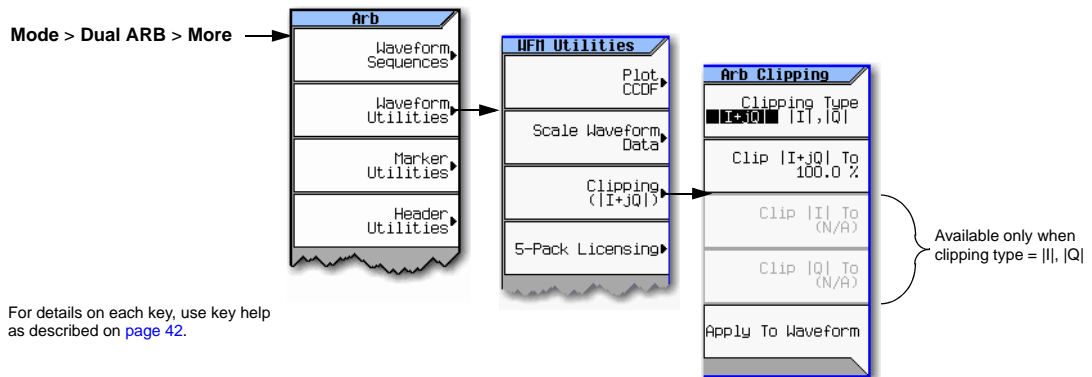

## How Power Peaks Develop

To see how clipping reduces high power peaks, it is important to understand how the peaks develop as you construct a signal.

### Multiple Channel Summing

I/Q waveforms can be the summation of multiple channels, as shown in the following figure. If a bit in the same state (high or low) occurs simultaneously in several individual channel waveforms, an unusually high power peak (positive or negative) occurs in the summed waveform.

Because the high and low states of the bits in channel waveforms are random and generally result in a cancelling effect, high power peaks occur infrequently with multiple channel summing.

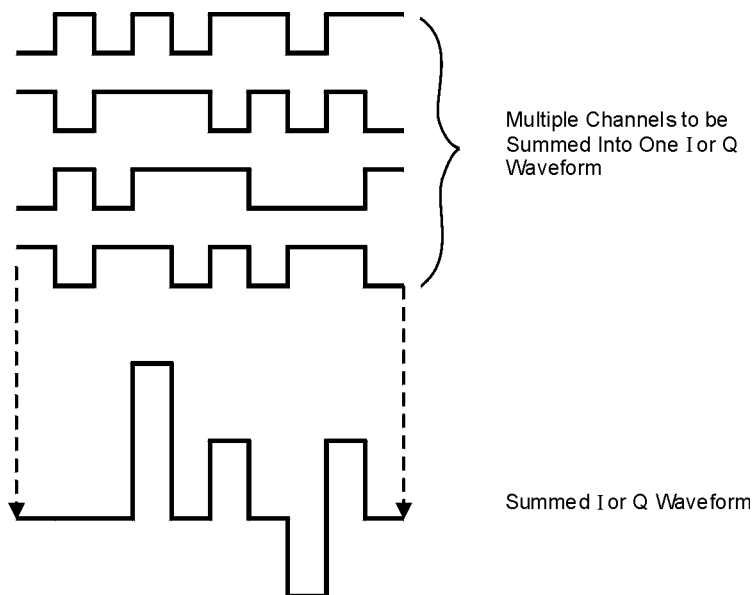

### Combining the I and Q Waveforms

When the I and Q waveforms combine in the I/Q modulator to create an RF waveform, the magnitude of the RF envelope is  $\sqrt{I^2+Q^2}$ , where the squaring of I and Q always results in a positive value.

As shown in the following figure, simultaneous positive and negative peaks in the I and Q waveforms do not cancel each other, but combine to create an even greater peak.

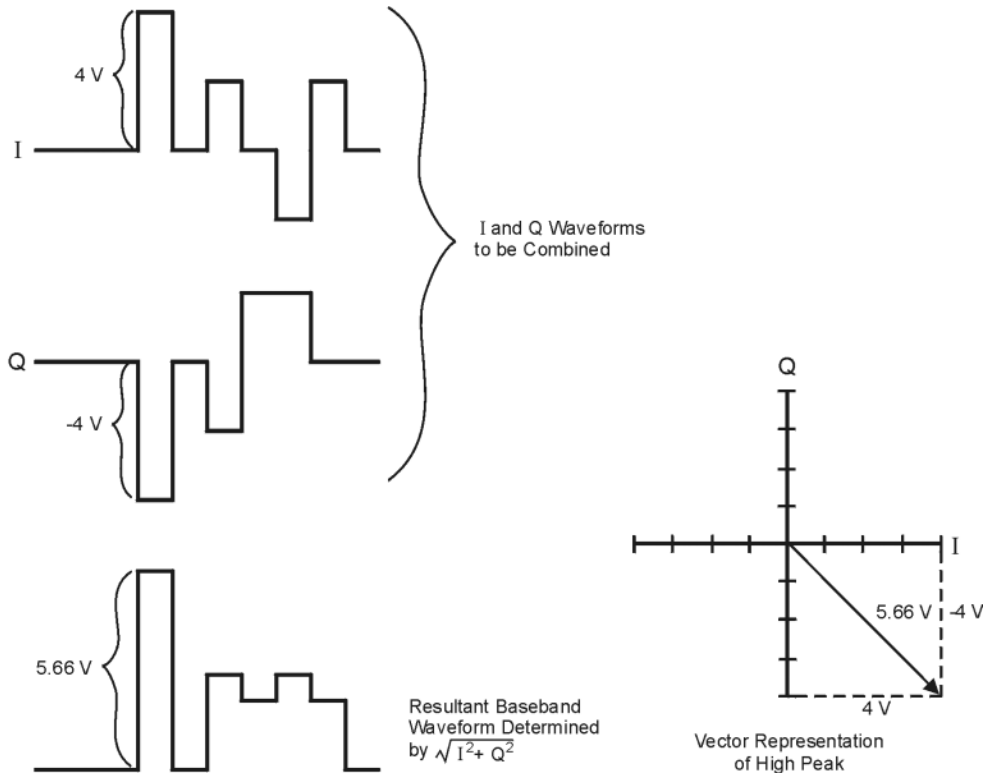

## How Peaks Cause Spectral Regrowth

In a waveform, high power peaks that occur infrequently cause the waveform to have a high peak-to-average power ratio, as illustrated in the following figure.

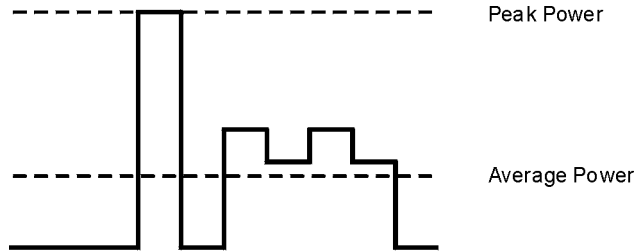

Because the gain of a transmitter's power amplifier is set to provide a specific average power, high peaks can cause the power amplifier to move toward saturation. This causes the intermodulation distortion that generates spectral regrowth. Spectral regrowth is a range of frequencies that develops on each side of the carrier (similar to sidebands) and extends into the adjacent frequency bands (see the following figure). Clipping provides a solution to this problem by reducing the peak-to-average power ratio.

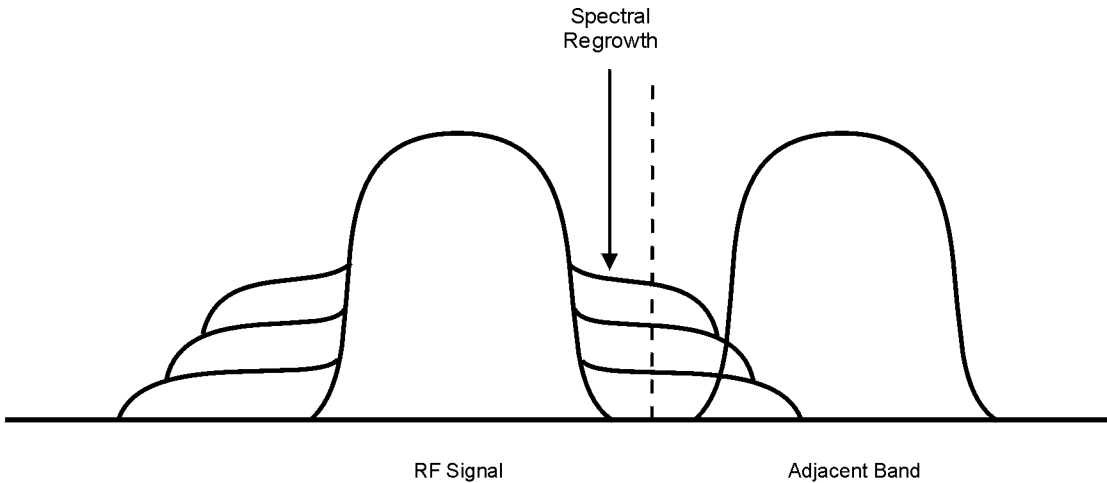

## How Clipping Reduces Peak-to-Average Power

You can reduce peak-to-average power, and consequently spectral regrowth, by clipping the waveform. Clipping limits waveform power peaks by clipping the I and Q data to a selected percentage of its highest peak. The Signal Generator provides two methods of clipping:

- *Circular* clipping is applied to the composite I/Q data (I and Q data are equally clipped).

As shown in [Figure 8-9](#), the clipping level is constant for all phases of the vector and appears as a circle in the vector representation.

- *Rectangular* clipping is independently applied the I and Q data.

As shown in [Figure 8-10 on page 186](#), the clipping level is different for I and Q, and appears as a rectangle in the vector representation.

In both circular and rectangular clipping, the objective is to clip the waveform to a level that reduces spectral regrowth but does *not* compromise the integrity of the signal. The two complementary cumulative distribution plots in [Figure 8-11 on page 187](#) show the reduction in peak-to-average power that occurs after applying circular clipping to a waveform.

The lower the clipping value, the lower the peak power that is passed (the more the signal is clipped). The peaks can often be clipped without substantially interfering with the rest of the waveform. In many cases, data that might otherwise be lost in the clipping process is retained because of the error correction inherent in the coded systems. If you apply excessive clipping, however, lost data cannot be recovered. Experiment with clipping settings to find a percentage that reduces spectral regrowth while retaining needed data.

**Figure 8-9 Circular Clipping**

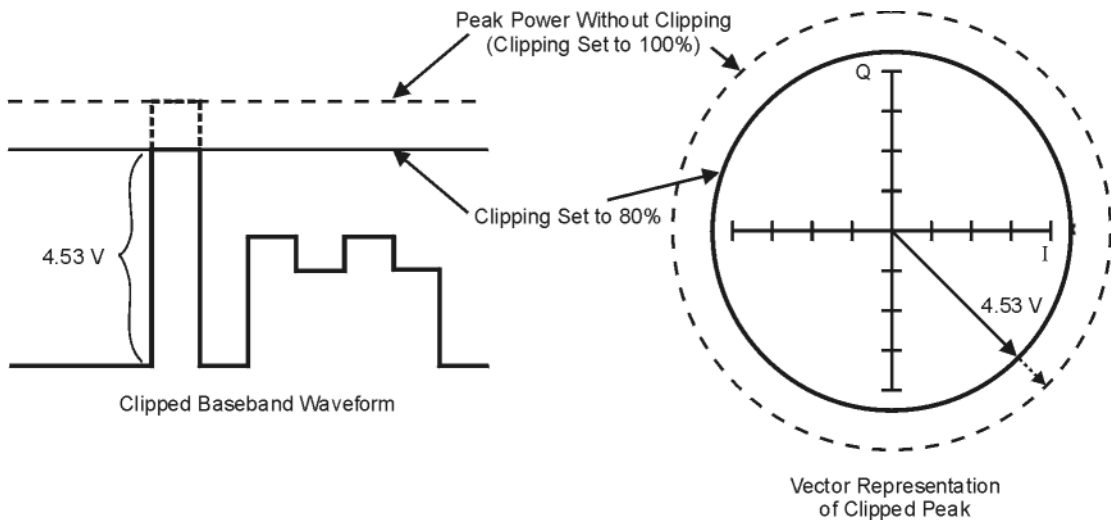
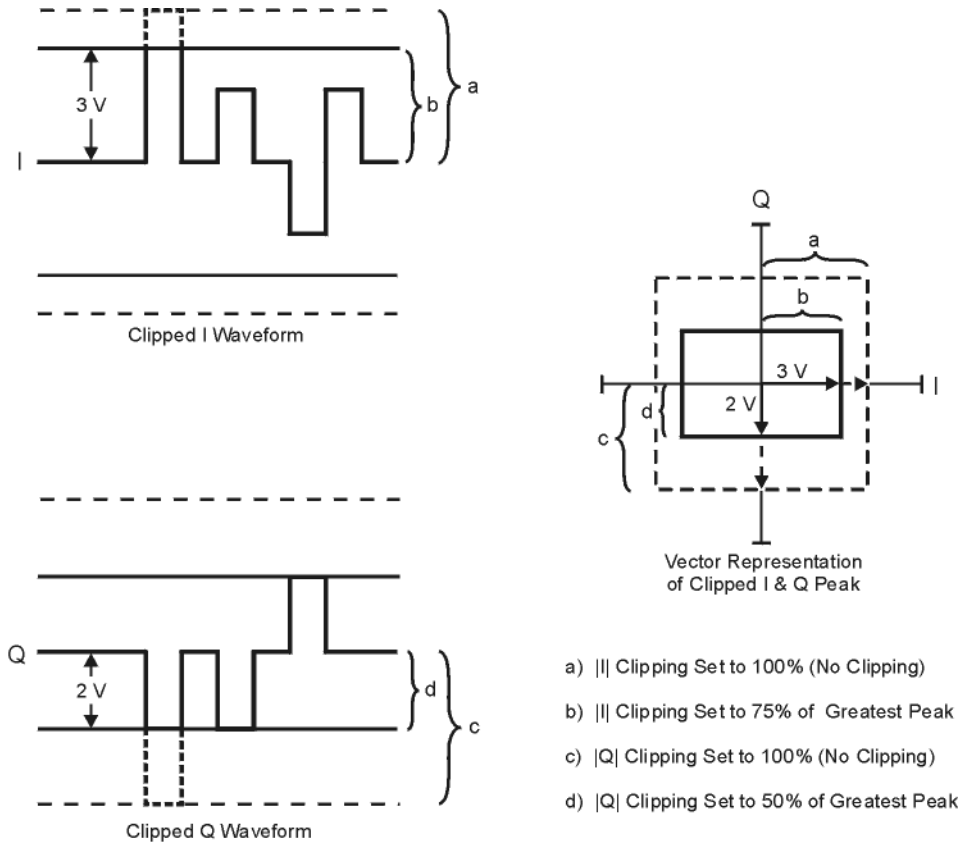

Figure 8-10 Rectangular Clipping



- a) |I| Clipping Set to 100% (No Clipping)
- b) |I| Clipping Set to 75% of Greatest Peak
- c) |Q| Clipping Set to 100% (No Clipping)
- d) |Q| Clipping Set to 50% of Greatest Peak



Figure 8-11 Reduction of Peak-to-Average Power

Complementary Cumulative Distribution

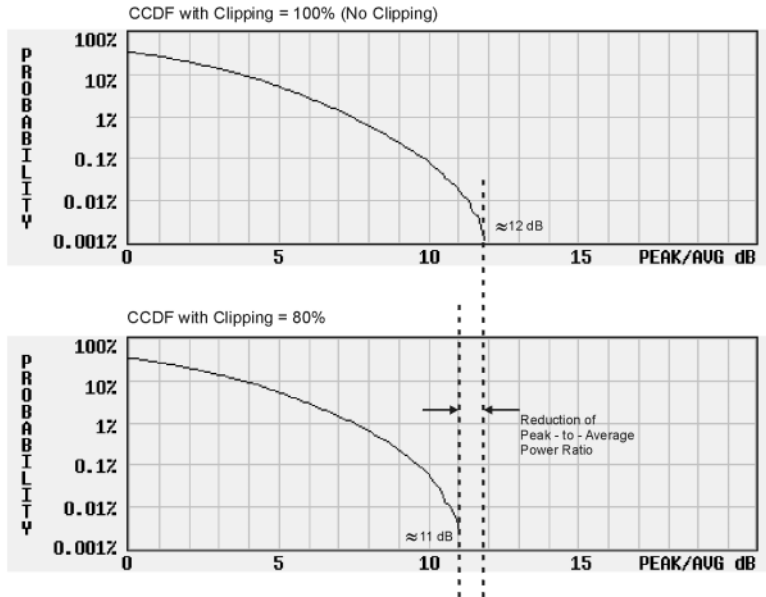

## Configuring Circular Clipping

Use this example to configure circular clipping and observe its affect on the peak-to-average power ratio of a waveform. Circular clipping clips the composite I/Q data (I and Q data are clipped equally). For more information about circular clipping, refer to [“How Clipping Reduces Peak-to-Average Power” on page 185](#).

---

**CAUTION** Clipping is non-reversible and cumulative. Save a copy of the waveform file before you apply clipping.

---

### Copy a Waveform File

1. Display the signal generator’s files: Press **File > Catalog Type > More > Volatile Segments**.
2. Highlight the waveform RAMP\_TEST\_WFM.
3. Press **Copy File**.
4. Name the copy (in this example, the name is MY\_TEST\_CIRC) and press **Enter**.

### Apply Circular Clipping to the Copied Waveform File

1. Open the DUAL ARB Waveform Utilities menu: Press **Mode > Dual ARB > More > Waveform Utilities**.
2. In the list of files, highlight the copied file (in this example, MY\_TEST\_CIRC).

3. Create the CCDF plot: Press **Plot CCDF**.
4. Observe the shape and position of the waveform’s curve (the dark line in the example at right).

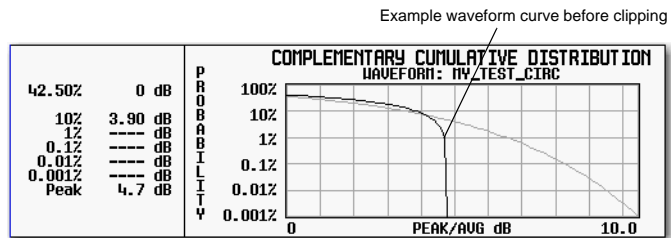

5. Activate circular clipping: Press **Return > Clipping > Clipping Type** until **|I+jQ|** highlights.

6. Set circular clipping to 80%: Press **Clip |I+jQ| To > 80 > %**.

7. Apply 80% clipping to the I and Q data: Press **Apply to Waveform**.

8. Create the CCDF plot (see the example at right): Press **Plot CCDF**.

9. Observe the waveform’s curve after clipping.

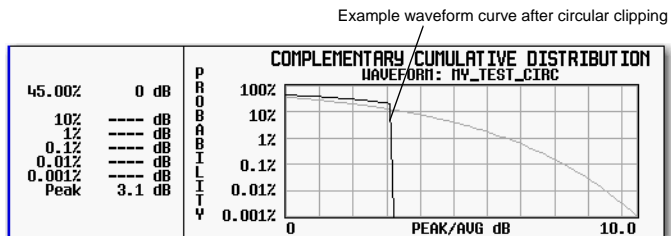

Note the reduction in peak-to-average power relative to the previous plot.

## Configuring Rectangular Clipping

Use this example to configure rectangular clipping. Rectangular clipping clips the I and Q data independently. For more information about rectangular clipping, refer to “How Clipping Reduces Peak-to-Average Power” on page 185.

---

**CAUTION** Clipping is non-reversible and cumulative. Save a copy of the waveform file before you apply clipping.

---

### Copy a Waveform File

1. Display the signal generator’s files: Press **File > Catalog Type > More > Volatile Segments**.
2. Highlight the waveform RAMP\_TEST\_WFM.
3. Press **Copy File**.
4. Name the copy (in this example, the name is MY\_TEST\_REC) and press **Enter**.

### Apply Rectangular Clipping to the Copied Waveform File

1. Open the DUAL ARB Waveform Utilities menu: Press **Mode > Dual ARB > More > Waveform Utilities**.
2. In the list of files, highlight the copied file (in this example, MY\_TEST\_REC).
3. Create the CCDF plot: Press **Plot CCDF**.
4. Observe the shape and position of the waveform’s curve (the dark line in the example at right).
5. Activate rectangular clipping: Press **Return > Clipping > Clipping Type** until **|I|,|Q|** highlights.
6. Set 80% clipping for the I data: Press **Clip |I| To > 80 > %**.
7. Set 40% clipping for the Q data: Press **Clip |Q| To > 40 > %**.
8. Apply the rectangular clipping to the waveform: Press **Apply to Waveform**.

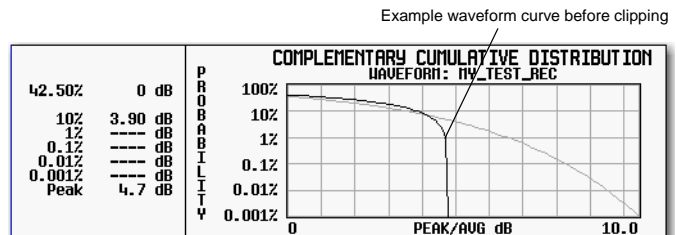

9. Create the CCDF plot (see the example at right): Press **Plot CCDF**.
10. Observe the waveform’s curve after clipping.  
Note the reduction in peak-to-average power relative to the previous plot.

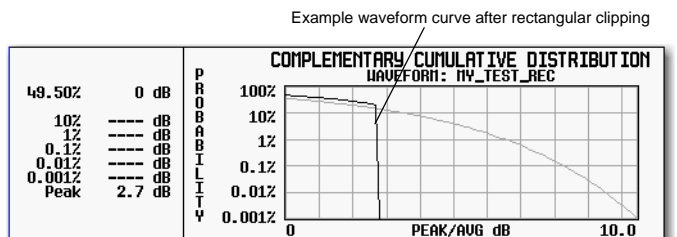

## Scaling a Waveform

The signal generator uses an interpolation algorithm (sampling between the I/Q data points) when reconstructing a waveform. For common waveforms, this interpolation can cause overshoots, which may create a DAC over-range error condition. This chapter describes how DAC over-range errors occur and how you can use waveform scaling to eliminate these errors.

- [How DAC Over-Range Errors Occur](#) on page 191
- [How Scaling Eliminates DAC Over-Range Errors](#) on page 192
- Agilent MXG waveform scaling on [page 193](#) and [page 194](#):
  - Waveform runtime scaling to scale a currently-playing waveform
  - Waveform scaling to permanently scale either the currently playing waveform, or a non-playing waveform file in BBG media

Figure 8-12 Scaling Softkeys

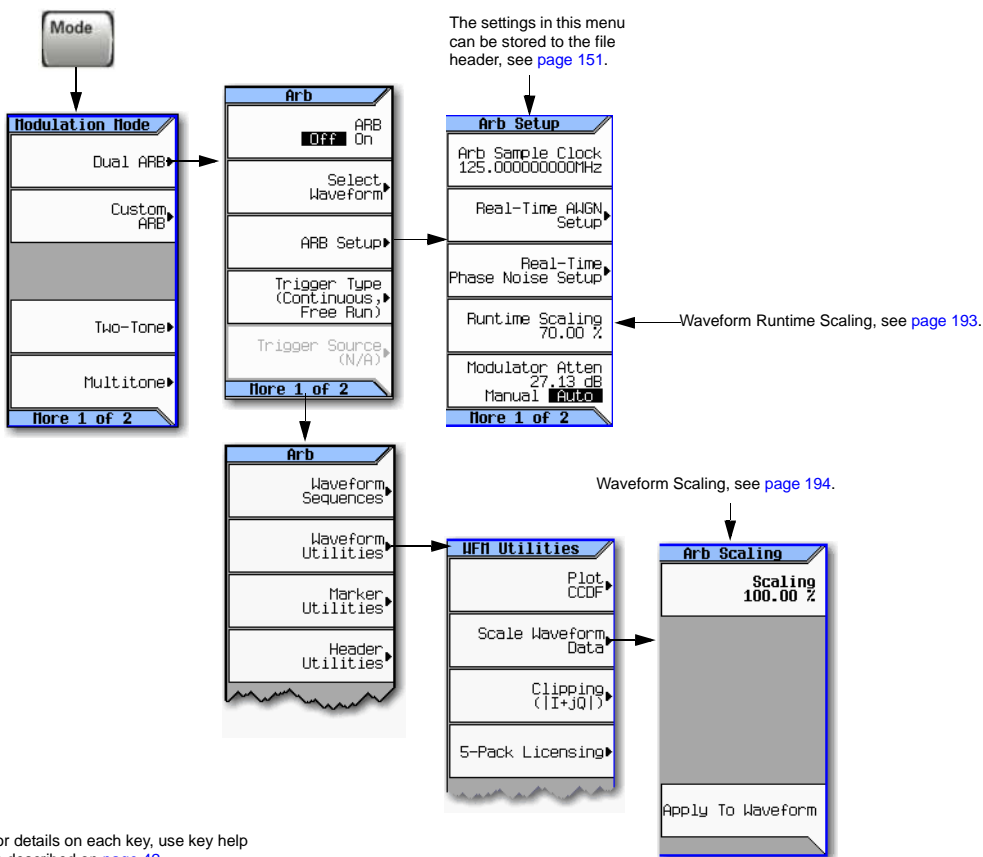

## How DAC Over-Range Errors Occur

The signal generator uses an interpolator filter when it converts digital I and Q baseband waveforms to analog waveforms. Because the clock rate of the interpolator is four times that of the baseband clock, the interpolator calculates sample points between the incoming baseband samples and smooths the waveform as shown in the figure at the right.

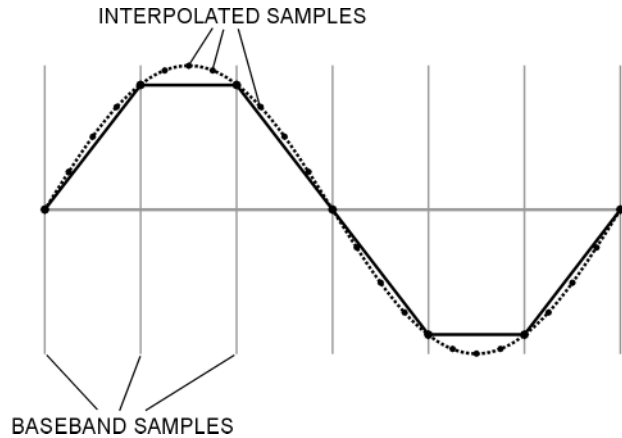

The interpolation filters in the DACs overshoot the baseband waveform. If a baseband waveform has a fast-rising edge, the interpolator filter's overshoot becomes a component of the interpolated baseband waveform. This response causes a ripple or ringing effect at the peak of the rising edge. If this ripple overshoots the upper limit of the DAC range, the interpolator calculates erroneous sample points and is unable to replicate the true form of the ripple (see the figure at the right). As a result, the signal generator reports a DAC over-range error.

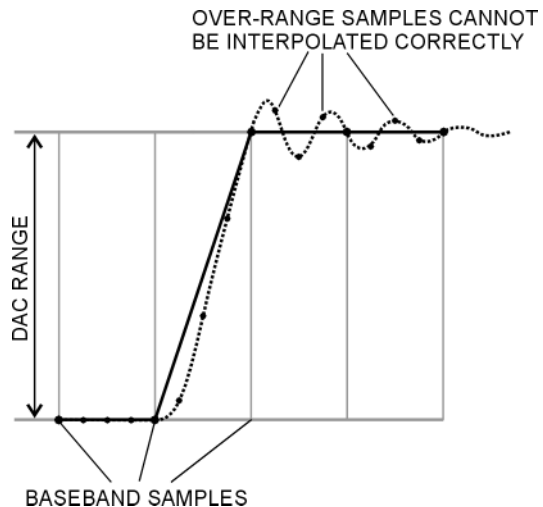

## How Scaling Eliminates DAC Over-Range Errors

Scaling reduces the amplitude of the baseband waveform while maintaining its basic shape and characteristics, such as peak-to-average power ratio. If the fast-rising baseband waveform is scaled enough to allow an adequate margin for the interpolator filter overshoot, the interpolator filter can calculate sample points that include the ripple effect and eliminate the over-range error (see the figure at the right).

Although scaling maintains the basic shape of the waveform, excessive scaling can compromise waveform integrity. For example, if the bit resolution becomes too low the waveform becomes corrupted with quantization noise. To achieve maximum accuracy and optimize dynamic range, scale the waveform no more than is required to remove the DAC over-range error. Optimum scaling varies with waveform content.

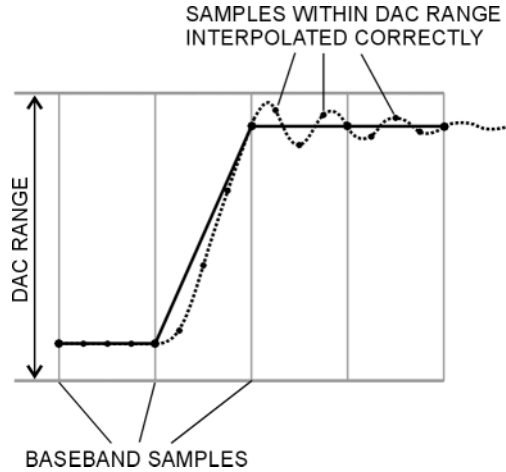

## Setting Waveform Runtime Scaling

Runtime scaling scales the waveform data during playback; it does not affect the stored data. You can apply runtime scaling to either a segment or sequence, and set the scaling value either while the ARB is on or off. This type of scaling is well suited for eliminating DAC over-range errors. Runtime scaling adjustments are not cumulative; the scaling value is applied to the original amplitude of the waveform file. There are two ways to save the runtime scaling setting: by using the save function (page 70) and by saving the setting to the file header (page 153). Saving to the file header saves the value with the waveform file, saving with the Save function stores the value as the current instrument setting.

Use this example to learn how to scale the currently selected waveform.

1. Select the waveform to which you want to apply scaling:
  - a. Press **Mode > Dual ARB > Select Waveform**.
  - b. Highlight the desired waveform (segment or sequence).
  - c. Press **Select Waveform**.
2. Play the selected waveform: Press **ARB Off On** until On highlights.
3. Set the Waveform Runtime Scaling value:
  - a. Press **ARB Setup > Waveform Runtime Scaling**.
  - b. Enter a scaling value.

The signal generator automatically applies the new scaling value to the waveform. There is no single value that is optimal for all waveforms. To achieve the maximum dynamic range, use the largest scaling value that does not result in a DAC over-range error.

- c. Press **Return**.

## Setting Waveform Scaling

Waveform scaling differs from waveform runtime scaling in that it permanently affects waveform data and only applies to waveform segments stored in BBG media. You scale the waveform either up or down as a percentage of the DAC full scale (100%). If you scale your waveforms using this method, you may also need to change the waveform runtime scaling value to accommodate this scaling.

When you scale, the signal generator permanently modifies the waveform file's sample values so that they conform to the desired scaling value. When you initiate scaling, the signal generator performs the following actions:

- locates the waveform file's absolute peak sample value
- determines its current percentage of full scale
- calculates the ratio of the desired scale value to the determined absolute peak sample scale value
- multiplies each sample in the waveform file by this ratio

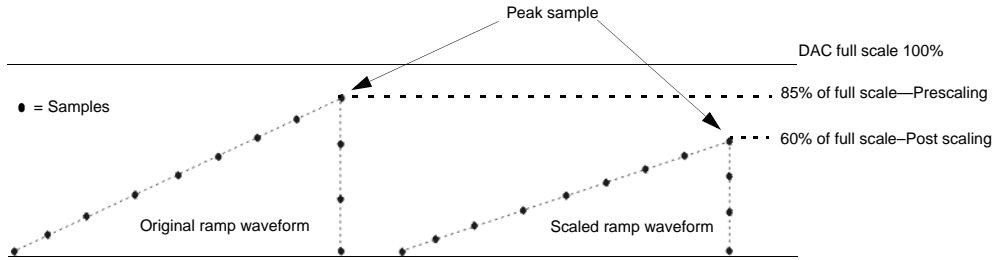

Scaled sample value = scaling ratio × prescale sample val

Scaling ratio = desired scale val / current scale val  
= 60 / 85  
= 0.70588

Each sample in the waveform is multiplied by 0.70588 to reach the 60% post scaling waveform amplitude.

When you scale a waveform, you can create fractional data, lose data, or both. Fractional data occurs almost every time you reduce or increase the scaling value, and causes quantization errors.

Quantization errors are more noticeable when scaling down, since you are closer to the noise floor. You lose data when either the signal generator rounds fractional data down or the scaling value is derived using the results from a power of two. This means that scaling a waveform in half (power of two:  $2^1 = 2$ ) causes each waveform sample to lose one bit. The waveform data modifications are not correctable and may cause waveform distortion. It is always best to make a copy of the original file prior to applying scaling.

Use the following examples to apply waveform scaling to a waveform file. While this process uses the factory-supplied waveform `RAMP_TEST_WFM`, it is the same for any waveform file.

### Copy a Waveform File

1. Display the waveform files in BBG media: Press **File** > **Catalog Type** > **More** > **Volatile Segments**.
2. Highlight the waveform `RAMP_TEST_WFM`.
3. Press **Copy File**.
4. Name the copy (this example uses the name `MY_TEST_SCAL`) and press **Enter**.



### Apply Scaling to the Copied Waveform File

---

**CAUTION** This type of scaling is non-reversible. Any data lost in the scaling operation cannot be restored. Save a copy of the waveform file before scaling.

---

1. Open the DUAL ARB Waveform Utilities menu:  
Press **Mode > Dual ARB > More > Waveform Utilities**.
2. In the list of BBG Media segment files, highlight the copied file (in this example, MY\_TEST\_SCAL).
3. Set and apply a scaling value (in this example 70% scaling is applied):  
Press **Scale Waveform Data > Scaling > 70 > % > Apply to Waveform**.

## Setting the Baseband Frequency Offset

The baseband frequency offset specifies a value to shift the baseband frequency up to  $\pm 50$  MHz within the BBG 100 MHz signal bandwidth, depending on the signal generator's baseband generator option. While the following figure shows how to access the control using the Dual ARB player, the location of the **Baseband Frequency Offset** softkey within each ARB format, through the **ARB Setup** softkey, is the same as for the Dual ARB player.

When the Baseband Frequency Offset is non-zero, the hardware rotator accumulates phase-shift of the baseband signal. This residual phase remains even after the offset value is returned to zero. To remove this phase accumulation, either restart the personality or select the **Baseband Frequency Offset Phase Reset** softkey. This softkey will grey out whenever the phase, due to the frequency offset, is zero. In addition, while there is a non-zero residual phase present in the signal, the DAC Over-Range Protection feature will automatically ensure that the reduced internal scaling is applied. This reduced scaling will be removed when both the frequency offset is returned to zero and the phase is reset.

Figure 8-13 Baseband Frequency Offset Softkey for the Dual ARB Player

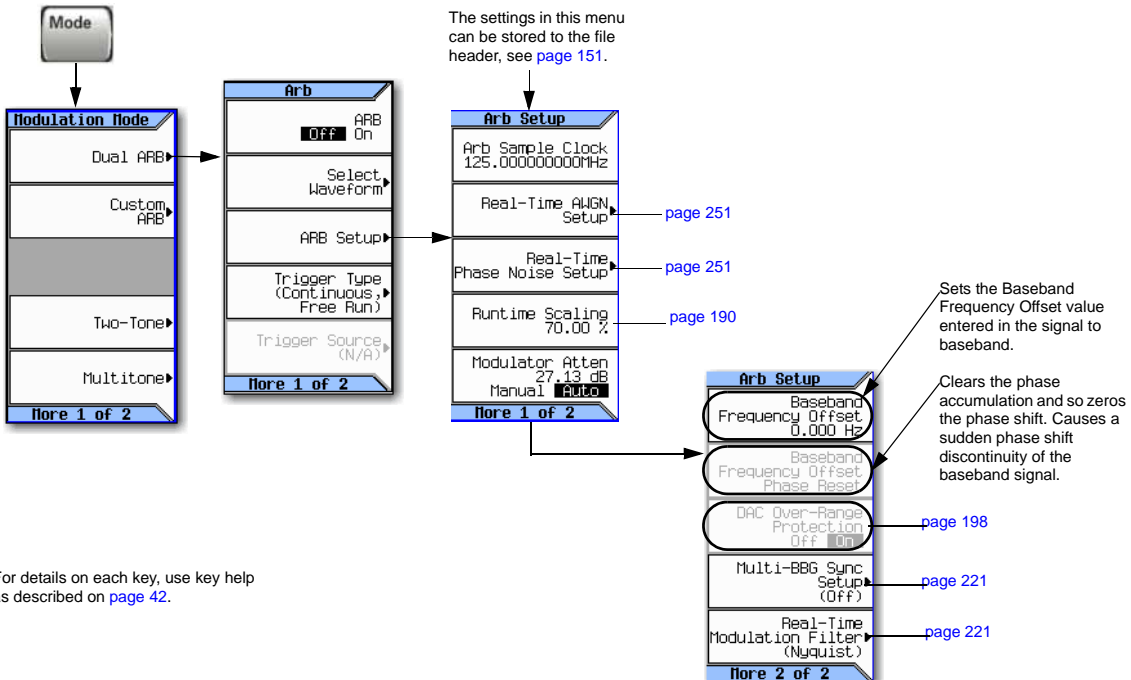

Common uses for the offset feature include:

- offsetting the carrier from any LO feedthrough (carrier signal spur at the carrier frequency)
- sum the baseband signal with external I and Q inputs to create a multicarrier signal
- use the signal generator's I/Q signal as an IF

---

**NOTE** Changing the baseband frequency offset may cause a DAC over range condition that generates error 628, Baseband Generator DAC over range. The signal generator incorporates an automatic scaling feature to minimize this occurrence. For more information, see “DAC Over-Range Conditions and Scaling” on page 198.

---

The baseband frequency offset value is one of the file header parameters (page 151), which means you can store this value with the waveform. When you select a waveform with a stored frequency offset value, the signal generator changes the current value to match the stored file header value. If there is no stored baseband offset frequency value for the current waveform, the signal generator uses the last set frequency offset value.

You can also use the Save function (page 70) to store this value as part of the signal generator setup. When you Recall a setup stored with the Save function, the baseband frequency offset value becomes the current instrument setting value, disregarding the stored file header value.

Use the following steps to offset the carrier from LO/carrier feedthrough. This example uses the factory supplied waveform, SINE\_TEST\_WFM available in the Dual ARB Player. To view the output for this example, connect the RF OUTPUT of the signal generator to the input of a spectrum analyzer.

1. Select and play the waveform.
  - a. Press **Mode > Dual ARB > Select Waveform**.
  - b. In the Segment On BBG Media column, select SINE\_TEST\_WFM.
  - c. Press **Select Waveform**.
2. Generate the waveform: Press **ARB Off On** to On.
3. Configure the carrier signal:
  - a. Set the carrier signal to 1 GHz.
  - b. Set the amplitude to 0 dBm.
  - c. Turn on the RF OUTPUT.
4. Press **Mode > Dual Arb > ARB Setup > More > Baseband Frequency Offset > 20 MHz**.

The modulated RF signal is now offset from the carrier frequency by 20 MHz as shown in the following figures.

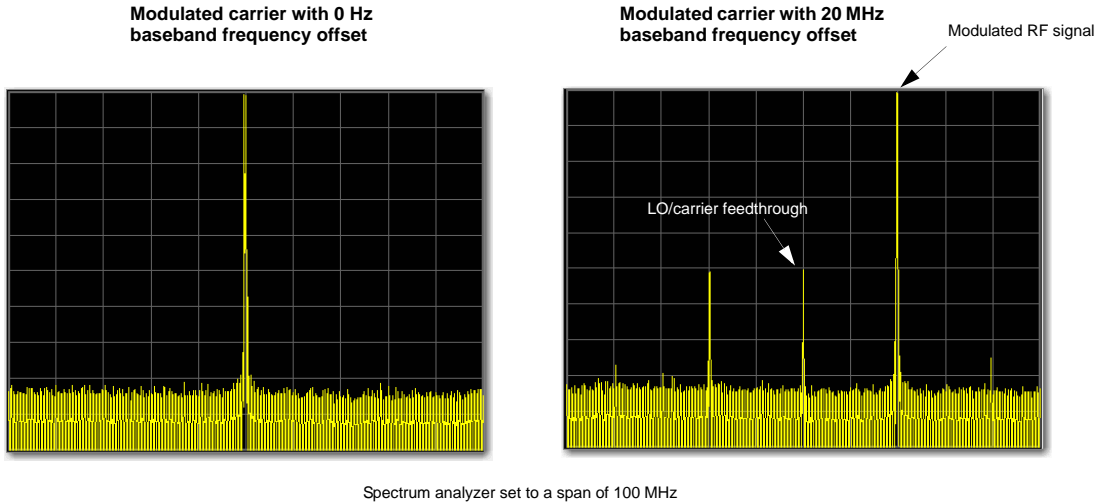

## DAC Over-Range Conditions and Scaling

When using the baseband frequency offset (at a setting other than 0 Hz), it is possible to create a DAC over-range condition, which causes the Agilent MXG to generate an error. To minimize this condition with the frequency offset feature, the Agilent MXG incorporates an automatic DAC over-range protection feature that scales down the I/Q data by *1/square root of 2* when the offset is something other than zero. Because it can scale the data by more than what is actually need, it typically decreases the dynamic range of the waveform. This is especially noticeable when using a constant amplitude signal such as GSM.

For the Dual ARB Player, this automatic over-range feature can be turned off. When on, it is active for the Dual ARB signal only when the offset is something other than 0 Hz. The control for the Dual ARB DAC over-range protection feature is located in the key path as shown in [Figure 8-14](#).

Figure 8-14 Dual ARB DAC Over-Range Protection Softkey Location

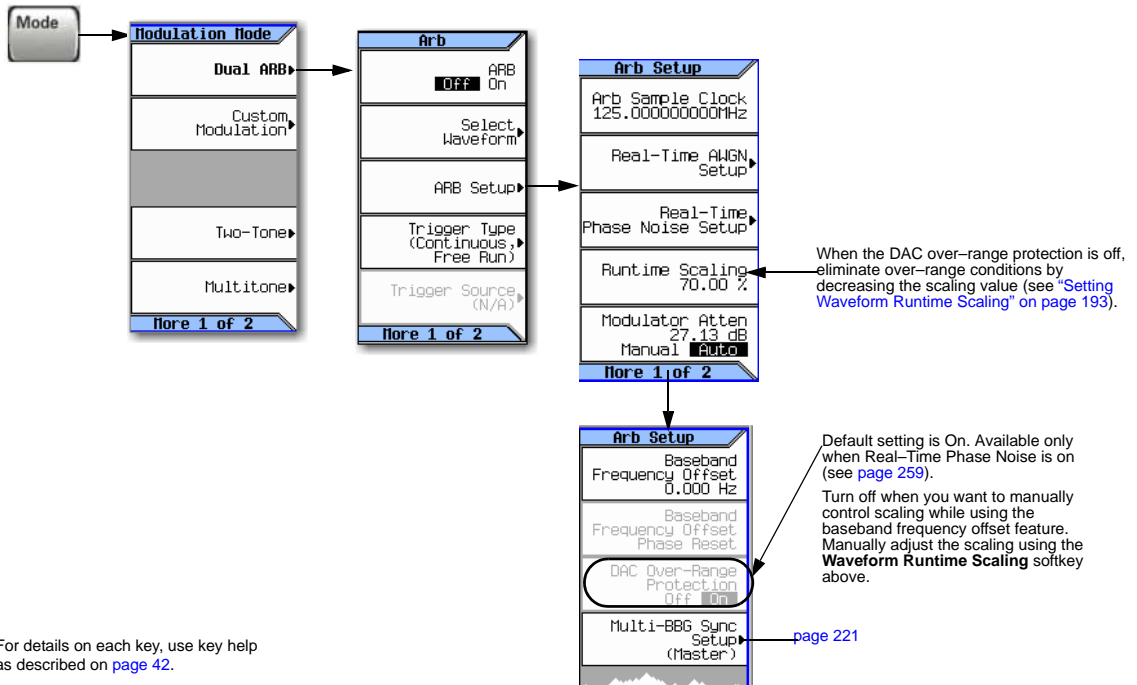

For details on each key, use key help as described on page 42.

In the Dual ARB Player, to avoid excessive scaling or to just perform scaling manually, turn the feature off and use the **Waveform Runtime Scaling** softkey to eliminate DAC over-range conditions.

## I/Q Modulation

The following factors contribute to the error of the I vector magnitude:

- Differences in amplitude, phase, and delay between the I and Q channels
- DC offsets

The I/Q menu not only enables you to select the I/Q signal source and output, it also provides adjustments and calibrations to compensate for differences in the I and Q signals.

See also, “Modulating the Carrier Signal” on page 60.

**Figure 8-15 I/Q Display and Softkeys**

**I/Q**

This panel displays the current status and settings of the I/Q adjustments. Use the **Page Up** and **Page Down** keys to scroll through these parameters. Grey indicates an inactive (off) adjustment.

This panel displays the current settings for the I/Q signal routing and I/Q correction optimized path.

**FREQUENCY** 6.000 000 000 00 GHz **AMPLITUDE** -144.00 dBm

**I/Q** **Off** I/Q On

**I/Q Source (Internal)**

**I/Q Correction Optimized Path (RF Output)**

**I/Q Adjustments (Off)** [page 203](#)

**I/Q Calibration**

**More 1 of 2**

**I/Q Routing & Optimization** **I/Q: Off**

BB GEN → I/Q OUT

EXT IN → RF OUT

Optimized Path

I Offset: +0.000 %  
Q Offset: +0.000 %  
Gain Balance: 0.00 dB  
Quad Angle Adj: 0.00 deg  
I/Q Skew: 0.000000000000 sec  
I/Q Delay: 0.000000000000 sec  
Ext In Offset I: +0.000 V  
Ext In Offset Q: +0.000 V  
Ext In Quad Angle Adj: 0.0

**I/Q Source**

Internal

External

Sum

These selections are reflected in the I/Q Routing & Optimization graphic.

**I/Q**

Int Phase Polarity **Normal** Invert

Burst Envelope **Off** On

Int Equalization Filter **Off**

Optimize Int I/Q Channel For **EVM** ACP

Inverts an internally generated Q signal, so that the I component lags the Q component by 90 degrees.

Used only with internally generated, bursted modulation formats. Enables/disables the RF burst modulator.

Opens the internal I/Q Equalization Filter which can be used to correct and/or impair the RF and External I/Q outputs for the internal I/Q source.

Selects between optimizing the internal I/Q channel for EVM (in channel performance) at the expense of ACP (out of channel performance) or optimizing for ACP at the expense of EVM.

EVM is an 80% nyquist filter (100Mhz wide) with a wide transition band. When an equalization filter is active, this filter is not active.

ACP is also an 80% nyquist filter (100Mhz wide), but the transition band is very narrow, thus reducing images for wide-band signals. This filter will be convolved with the active equalization filter, the result of which will be truncated to the center 256 taps.

SCPI Commands:

```
[[:SOURCE]:DM:INTERNAL:CHANNEL:OPTimization EVM|ACP
[:SOURCE]:DM:INTERNAL:CHANNEL:OPTimization?
```

**I/Q Optimization**

RF Output

Ext I/Q Output

Each path requires different optimization values; when you select a path, you are selecting the unique optimization values required by that path. The signal generator applies the selected optimization values to both paths, which impairs the unselected path.

For details on each key, use key help as described on [page 42](#).

## Using the Rear Panel I and Q Outputs

**NOTE** The rear panel I and Q connectors only output a signal while using the internal BBG.

In addition to modulating the carrier, the signal generator also routes the internally generated I and Q signals to the rear panel I and Q connectors. These output signals are post DAC, so they are in analog form. You can use these rear panel I and Q signals to:

- drive a system's transmitter stage
- test individual analog I and Q components such as an I/Q modulator
- route the I and Q signals into another signal generator

The factory default setting routes the internally generated I and Q signals to the I/Q modulator and the rear panel I and Q output connectors. However, to optimize (apply calibration factors) the rear panel signals, you need to select the external I/Q output path.

### Select and Play a Waveform

1. Press **Mode > Dual ARB > Select Waveform**.
2. Highlight the desired waveform.
3. Press **Select Waveform > ARB Off On to On**.

### Optimize the Signal Path

1. Connect cables from the rear panel I and Q connectors to either a DUT or another signal generator.

When you turn the ARB on, the signal generator automatically outputs the I and Q signals to the rear panel connectors. You can use the rear panel I and Q signals as I and Q inputs to another signal generator. The MXG has front panel connectors, I Input and Q Input, for this purpose.

2. Press **I/Q > I/Q Correction Optimized Path > Ext I/Q Output**.

When you optimize a path, the path indicator turns green.

Factory default setting—RF Output path optimized

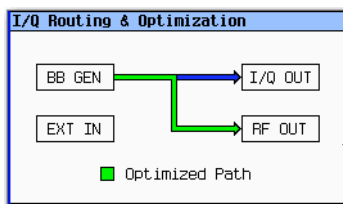

Rear panel I/Q path optimized

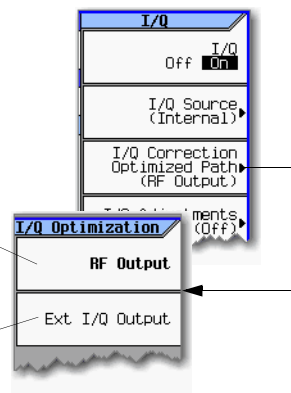
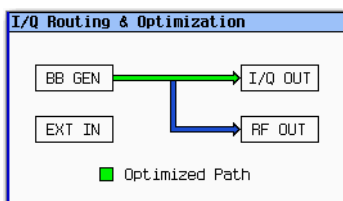

## Configuring the Front Panel Inputs

The signal generator accepts externally supplied analog I and Q signals through the front panel I Input and Q Input. You can use the external signals as the modulating source, or sum the external signals with the internal baseband generator signals.

1. Connect I and Q signals to the front panel connectors.
  - a. Connect an analog I signal to the signal generator's front panel I Input.
  - b. Connect an analog Q signal to the signal generator's front panel Q Input.
2. Set the signal generator to recognize the front panel input signals:
  - **To Modulate onto the Carrier**  
Press **I/Q > I/Q Source > External**.

Signal generator display: both paths are calibrated when the **I/Q Correction Optimized Path** is set to **Ext I/Q Output** (see [page 201](#))

**Note:** when the optimized path is set to RF, *only* the RF Out path is calibrated.

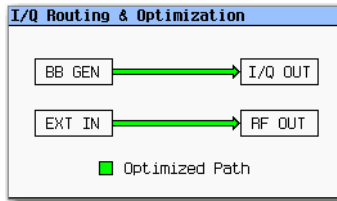

- **To Sum and Modulate onto the Carrier**  
Press **I/Q > I/Q Source > Sum**.

To select and play a waveform for the BB GEN path, see [page 145](#).

Signal generator display: both RF paths are calibrated when the **I/Q Correction Optimized Path** is set to **RF Output** (see [page 201](#))

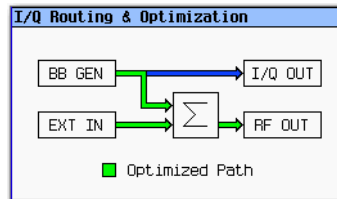

Notice that only the internal BBG (BB GEN) routes I and Q signals to the rear panel I and Q outputs.

3. If you are using only the external I and Q signals (no summing), turn on the I/Q modulator:  
Press **I/Q Off On** to On.
4. Configure the RF output:
  - a. Set the carrier frequency.
  - b. Set the carrier amplitude.
  - c. Turn the RF output on.



## I/Q Adjustments

Use the I/Q Adjustments to compensate for or add impairments to the I/Q signal.

Adjusts the I signal amplitude relative to the Q signal amplitude. Use this as an internal impairment, or to compensate for differences in signal path loss that occur due to path irregularities in the external I and Q output cabling.

The DC offset values are calibrated relative to the RMS waveform voltage being played out of the ARB. See page 154.

### I/Q > I/Q Adjustments

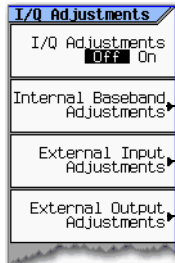

This feature allows adjustment of the absolute phase of the internal I/Q channel by rotating both I and Q, thus adjusting the relative phase of the RF carrier. For option 012, this is the only way to adjust the RF phase for a unit with an external LO.

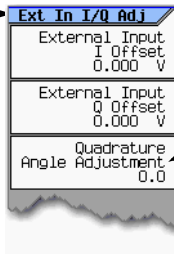

Offsets the phase of the Q signal relative to the phase of the I signal. The baseband quadrature adjustment key is calibrated in units of degrees. The external input quadrature adjustment is not calibrated. The function provided by this key is not the same as the function provided by the I/Q Skew key.

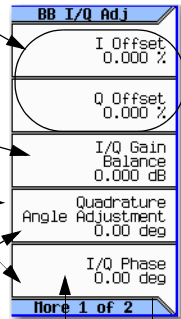

Note: The I/Q signal will be scaled down by 0.7071 for all phase offsets except 0. Use -360 or +360, if it is desirable to maintain a constant power level with the ALC off while adjusting the I/Q phase.

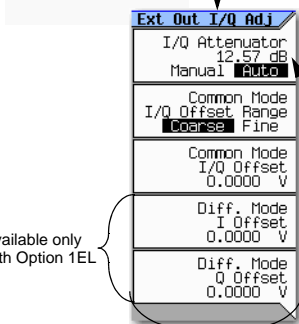

Available only with Option 1EL

The I/Q Attenuator softkey affects the I/Q signal to the RF Output and the External I/Q Outputs.

This softkey is active when the I/Q optimized path is set to **Ext I/Q Output** and a digital modulation personality is on. This attenuation is also adjustable using the **Mod Attenuator** key located in the Arb Setup menus in each personality. This adjustment is not affected by the I/Q Adjustments On/Off key.

When Auto mode is selected, the signal generator automatically optimizes I/Q attenuation for the current conditions. When the Manual mode is selected, I/Q Attenuation is the active function. The value you enter sets the attenuation level of the I/Q signal.

SCPI Commands (Refer to the commands for each personality):  
[:SOURCE]:RADio:<personality>:IQ:MODulation:ATTen

**Skew** is typically used either to create impairments, or to reduce error vectors on large bandwidth signals.

Provides a relative time delay correction between the I and Q signals. The different signal paths traveled by the I and Q signals result in time delay differences that show up as an EVM error in large bandwidth modulated signals.

Adding an equal and opposite time delay (skew) in the I/Q signals during baseband generation eliminates the time delay error, correcting for any delays in signals that are generated in the internal baseband generator.

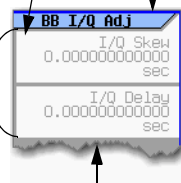

Available only when a waveform is playing.

Changes the absolute phase of both the I and Q signals with respect to triggers and markers.

Positive values add delay and negative values advance the signals. This value affects both the baseband signal modulated onto the RF and the external output signals (I and Q). This setting cannot be used with constant envelope modulation and it does not affect external I and Q inputs.

**Offsets** are typically used to either reduce carrier leakage, or to create an impairment that simulates carrier leakage.

#### Common Mode I/Q Offset Range

This changes the adjustment range of the Common Mode I/Q Offset from Coarse (Default) to fine or vice versa. The Coarse range corresponds to the default value of  $\pm 2.5V$ . The Fine range corresponds to a value of  $\pm 100$  mV.

#### Common Mode I/Q Offset

This adjusts the DC offset of both I and Q signals simultaneously.

#### Diff Mode I Offset

This adjusts the DC offset level of the I and I-bar output signal. I and I-bar cannot be adjusted independently.

#### Diff Mode Q Offset

This adjusts the DC offset level of the I and I-bar output signal. I and I-bar cannot be adjusted independently.

**Table 8-2 I/Q Adjustments Uses**

<b>I/Q Adjustment</b>	<b>Effect</b>	<b>Impairment</b>
Offset	Carrier feedthrough	dc offset
Quadrature Angle	EVM error	phase skew
	I/Q images	I/Q path delay
I/Q Skew	EVM error	high sample rate phase skew or I/Q path delay
I/Q Gain Balance	I/Q amplitude difference	I/Q gain ratio
I/Q Phase	I/Q phase rotation	RF phase adjustment

The I/Q adjustment, I/Q Delay, is not for adding impairments; its function is to compensate for any latency between the EVENT output signals (marker signals) and the RF output.

## I/Q Calibration

Use the I/Q calibration for I and Q signal corrections. What aspects of the I and Q signal is corrected depends on whether the signal is internally or externally generated.

Correction	Internal I and Q	External I and Q
Offset	X	X
Gain Balance	X	--
Quadrature Error	X	X

When you perform an I/Q calibration, that calibration data takes precedence over the factory-supplied calibration data. The calibration routines improve performance that may degrade over time or due to temperature changes. An I/Q calibration should be run when the ambient temperature has varied by at least  $\pm 5$  degrees Celsius from the ambient temperature at which the previous calibration was run.

---

### CAUTION

For firmware revisions  $\geq$ A.01.50, the behavior for the I/Q calibration is:

- The user I/Q calibration is persistent (i.e. Pressing instrument preset or cycling power does not remove the user I/Q calibration from memory).
- If the start and stop frequencies are set to the same value, then the calibration will be performed exactly at that frequency and the data will be persisted in the bounding calibration array elements.

For firmware revisions  $\leq$ A.01.50:

- The user I/Q calibration is not persistent (i.e. Pressing instrument preset or cycling power removes the user I/Q calibration from memory).
  - If the start and stop frequencies are set to the same value, the calibration is performed at the bounding calibration array elements and persisted in the bounding calibration array elements.
-

I/Q > I/Q Calibration

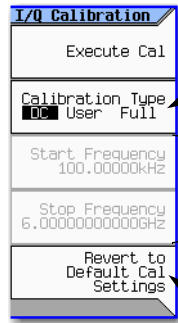

Available only when Calibration type = User

Deletes any user-generated calibration data and restores the factory-supplied calibration data.

**DC** optimizes the I/Q performance for the current instrument settings, and typically completes in several seconds. Changing any instrument setting after performing a DC calibration voids the DC calibration and causes the signal generator to revert to the user calibration data (or factory-supplied calibration data, if no user calibration data exists)

**User** provides a quicker calibration when a full calibration is not required. You can limit the calibration by specifying the calibration start and stop frequencies.

When you limit the calibration to less than the instrument's full frequency range, the factory-supplied calibration data is used for the rest of the range. If the start and stop frequencies are set to the same value, then the calibration will be performed exactly at that frequency and the data will be persisted in the bounding calibration array elements. Information is retained through a preset or power cycle\*.

**Full** takes approximately a minute, executing measurements over the instrument's entire frequency range.

Information is retained through a preset or power cycle\*.

**\*Caution:**

To avoid the loss of data, GPIB settings, or current user instrument states that have not been permanently saved to non-volatile memory, the MXG should always be powered down either via the MXG's front panel power button or the appropriate SCPI command. MXG's installed in rack systems and powered down with the system rack power switch rather than the MXG's front panel switch display a Error -310 due to the MXG not being powered down correctly.

**Note**

A DC calibration requires the following settings:

- I/Q: On
- Optimized Path: RF Output
- Source: Internal

For details on each key, use key help as described on [page 42](#).

## Using the Equalization Filter

An equalization FIR file can be created externally, uploaded via SCPI, and subsequently selected from the file system (refer to “[Working with Files](#)” on page 62). For information related to downloading FIR file coefficients, refer to the *Programming Guide*. For information regarding working with FIR file coefficients manually, refer to “[Modifying a FIR Filter Using the FIR Table Editor](#)” on page 215.

This filter can be used to correct and/or impair the RF and External I/Q outputs for the internal I/Q source. This filter will be convolved with the ACP Internal I/Q Channel Optimization filter if that filter is selected, the result of which will be truncated to the center 256 taps. The equalization filter operates at 125MHz, so all equalization filters must be resampled to 125MHz prior to selection, if they are sampled at some other rate.

The MXG supports equalization filters—either Complex or Real—that are programmable FIR filters with two inputs (I, Q) and two outputs (I, Q) per sample. This 256-tap filter has two modes of operation:

---

**NOTE** The maximum number of taps is 256 (with 2 coefficients per tap for a complex filter) for equalization filters. The minimum number of taps is 2.

Equalization filters can also be referred to as predistortion filters or correction filters.

---

Type of Filter	Description
Real	The I and Q samples are independently filtered by a single set of real coefficients.
Complex	The samples are treated as complex ( $I + jQ$ ) and convolved with the filter coefficients which are specified as $(I + jQ)$ in the time domain.

The equalization filter can be turned on and off.

**Figure 8-16 Int Equalization Filter Softkeys**

For details on each key, use key help as described on [page 42](#).

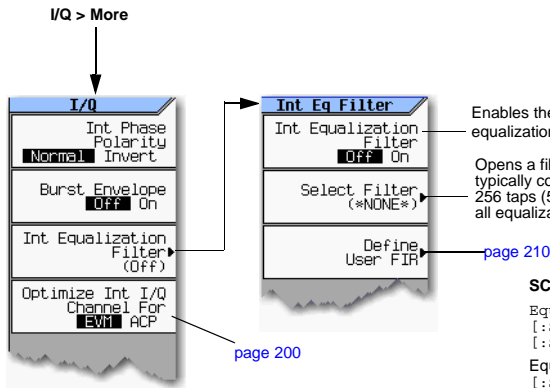

**SCPI commands:**

Equalization filter state:  
[:SOURCE]:DM:INTERNAL:EQUALIZATION:FILTer:STATe { OFF } | ON  
[:SOURCE]:DM:INTERNAL:EQUALIZATION:FILTer:STATe?

Equalization filter selection:  
[:SOURCE]:DM:INTERNAL:EQUALIZATION:FILTer:SElect "filename"  
[:SOURCE]:DM:INTERNAL:EQUALIZATION:FILTer:SElect?

To add a real filter to the file system:

```
:MEMory:DATA:FIR "filename", [REAL,] osr, coeff1 [,coeff2 [...,coeffN]]
:MEMory:DATA:FIR? "filename"
```

To add complex filter to the file system:

```
:MEMory:DATA:FIR "filename", COMpLex, osr, hIRe0, hQIm0 [, hIRe1, hQIm1 [..., hIReN, hQImN]]
:MEMory:DATA:FIR? "filename"
```

To add I/Q symbol data to the file system:

```
:MEMory:DATA "WFM1:filename", <blockdata>
```

**Note:**

Use the FIR Table editor to view the filter's coefficients. Refer to [page 215](#).

For more information on the SCPI commands, refer to the *SCPI Command Reference*.

## Using Finite Impulse Response (FIR) Filters in the Dual ARB Real-Time Modulation Filter

Finite Impulse Response filters can be used to compress single carrier I/Q waveforms down to just the I/Q constellation points and then define the transitions similar to the modulation filter in Arb Custom (refer to “Using Finite Impulse Response (FIR) Filters in ARB Custom Modulation” on page 281). The key difference for dual ARB real-time modulation is that a filter is applied as the waveform plays, rather than in the waveform data itself.

**Figure 8-17 Filter Menu**

Mode > Dual ARB > Arb Setup > More > Real-Time Modulation Filter >

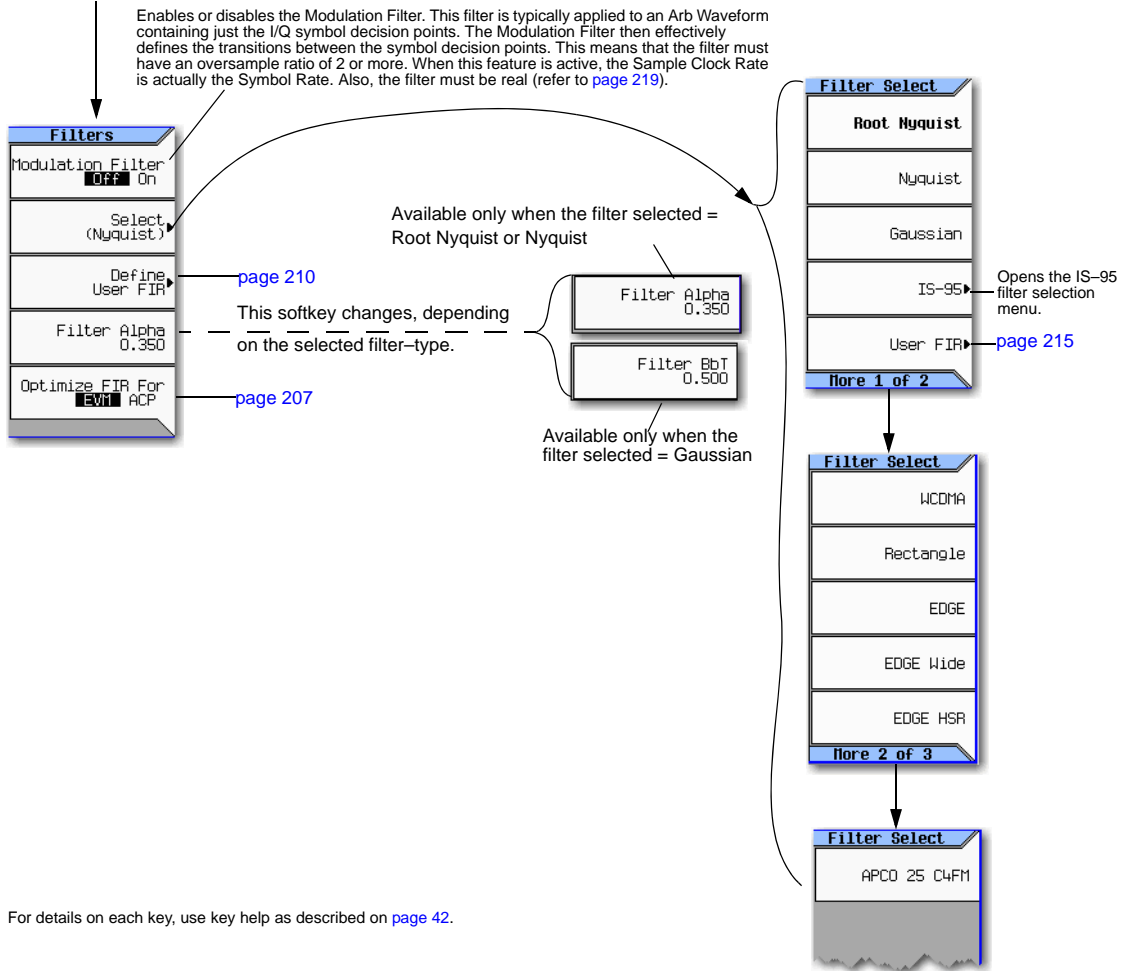

## Creating a User-Defined FIR Filter Using the FIR Table Editor

In this procedure, you use the FIR Values table editor to create and store an 8-symbol, windowed sync function filter with an oversample ratio of 4.

### Accessing the Table Editor

1. Press **Preset**.
2. Press **Mode > Dual ARB > Arb Setup > More > Real-Time Modulation Filter > Select > Nyquist**.
3. Press **Define User FIR**.
4. Press **More 1 of 2 > Delete All Rows > Confirm Delete of All Rows**.

This will initialize the table editor as shown in [Figure 8-18](#).

**Figure 8-18** Creating a User-Defined FIR Filter Using the FIR Filter Table Editor

Mode > Dual ARB > Arb Setup > More > Real-Time Modulation Filter > Define User FIR > More 1 of 2 > Delete All Rows > Confirm Delete of All Rows

For details on each key, use key help as described on [page 42](#).

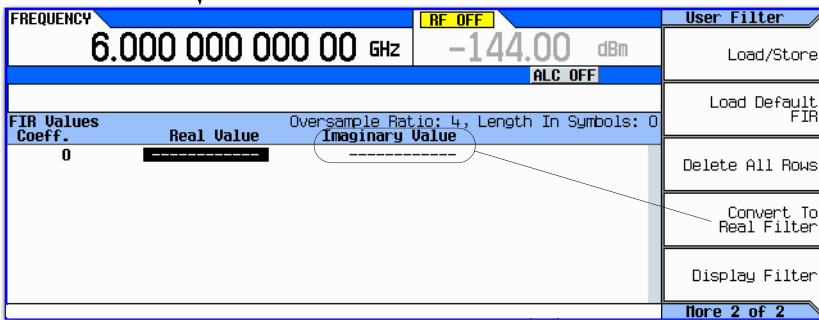

Opens a menu that enables you to select and load a saved file into volatile memory. See [page 43](#).

[page 216](#)

Adds a column for specifying the imaginary coefficients of the filter.\* (All of the imaginary coefficients will be 0 initially.) If the Convert to Complex Filter softkey has been selected the Convert to Real Filter softkey becomes available.

Caution: Selecting the Convert to Real Filter softkey removes the Imaginary Values column and the imaginary values are lost.

Active only when:  
FIR filter coefficient table has minimum of two values visible.

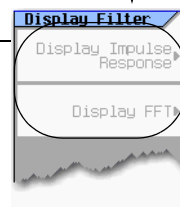

#### Note:

Modulation filters must be real and have an oversample ratio (OSR) of 2 or greater. Equalization filters are typically complex and must have an oversample ratio (OSR) of 1.

### Entering the Coefficient Values

1. Press the **Return** softkey to get to the first page of the table editor.
2. Use the cursor to highlight the Value field for coefficient 0.



3. Use the numeric keypad to type the first value (–0.000076) from [Table 8-3](#). As you press the numeric keys, the numbers are displayed in the active entry area. (If you make a mistake, you can correct it using the backspace key.)
4. Continue entering the coefficient values from the table in step 1 until all 16 values have been entered.

**Table 8-3**

Coefficient	Value
0	–0.000076
1	–0.001747
2	–0.005144
3	–0.004424
4	0.007745
5	0.029610
6	0.043940
7	0.025852

Coefficient	Value
8	–0.035667
9	–0.116753
10	–0.157348
11	–0.088484
12	0.123414
13	0.442748
14	0.767329
15	0.972149

### Duplicating the First 16 Coefficients Using Mirror Table

In a windowed sinc function filter, the second half of the coefficients are identical to the first half in reverse order. The signal generator provides a mirror table function that automatically duplicates the existing coefficient values in the reverse order.

1. Press **Mirror Table**. The last 16 coefficients (16 through 31) are automatically generated and the first of these coefficients (number 16) highlights, as shown in [Figure 8-19](#) on page 212.

**Figure 8-19**

FIR table coefficient values, may be from the factory default values or entered by the user.

FREQUENCY		AMPLITUDE		User Filter
6.000 000 000 00 GHz		-144.00 dBm		Insert Row
				Delete Row
FIR Values (UNSTORED)				Oversample Ratio: 4
Coef.	Value	Length In Symbols: 8		Goto Row▶
10	-0.157348			Mirror Table
11	-0.088484			Oversample Ratio 4
12	0.123414			
13	0.442748			
14	0.767329			
15	0.972149			
16	<b>0.972149</b>			
17	0.767329			
18	0.442748			
19	0.123414			
				02/20/2007 12:28 More 1 of 2

Use the Goto Row menu to move around and make changes to the FIR Values coefficient table.

For details on each key, use key help as described on [page 42](#).

## Setting the Oversample Ratio

**NOTE** Modulation filters are real and have an oversample ratio (OSR) of two or greater. Equalization filters are typically complex and must have an OSR of one (refer to “Using the Equalization Filter” on page 207 and to “Setting the Real-Time Modulation Filter” on page 219).

The oversample ratio (OSR) is the number of filter coefficients per symbol. Acceptable values range from 1 through 32; the maximum number of taps allowed by the table editor is 1024.

The actual limits on OSR, number of coefficients, and number of symbols depends on the feature with which the FIR is used. Refer to [Table 8-4](#).

**Table 8-4**

Filter Type	Oversampling Ratio (OSR)	Number of Taps (Maximum)	Symbols/Coefficients (Maximum)
Equalization <sup>a</sup>	1	256	--
ARB Custom Modulation <sup>b</sup>	≥ 2	--	512/1024
Dual ARB Real-Time Modulation <sup>c</sup>	≥ 2	--	32/1024

<sup>a</sup>When I/Q timing skew, I/Q delay, or the ACP internal I/Q channel optimization features are active, the effective number of taps for the equalization filter are reduced.

<sup>b</sup>The filter may be sampled to a higher or lower OSR.

<sup>c</sup>The filter will be decimated to a 16 or lower OSR depending on the symbol rate.

For modulation filters, if the oversample ratio is different from the internal, optimally selected one, then the filter is automatically resampled to an optimal oversample ratio.

For this example, the desired OSR is 4, which is the default, so no action is necessary.

## Displaying a Graphical Representation of the Filter

The signal generator has the capability of graphically displaying the filter in both time and frequency dimensions.

1. Press **More 1 of 2 > Display FFT** (fast Fourier transform).

Refer to [Figure 8-20 on page 214](#).

Figure 8-20

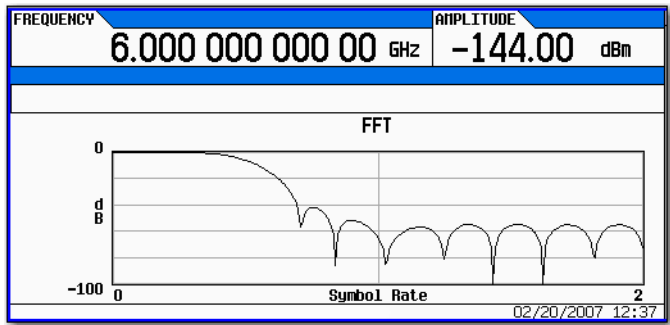

For details on each key, use key help as described on page 42.

2. Press **Return**.
3. Press **Display Impulse Response**.

Refer to Figure 8-21.

Figure 8-21

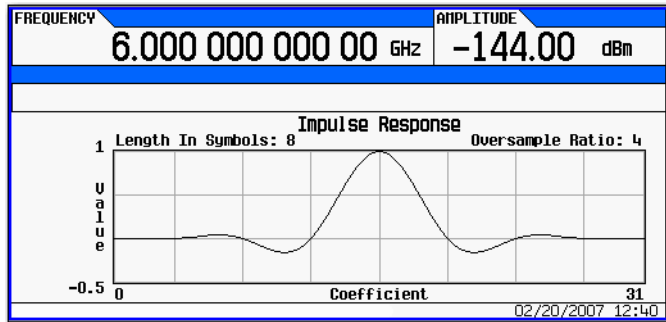

For details on each key, use key help as described on page 42.

4. Press **Return** to return to the menu keys.

### Storing the Filter to Memory

Use the following steps to store the file.

1. Press **Load/Store > Store To File**. The catalog of FIR files appears along with the amount of memory available.
2. As described in [Storing, Loading, and Playing a Waveform Segment](#) on page 144, name and store this file as **FIR\_1**.

The FIR\_1 file is the first file name listed. (If you have previously stored other FIR files, additional file names are listed below FIR\_1.) The file type is FIR and the size of the file is 260 bytes. The amount of memory used is also displayed. The number of files that can be saved depends on the size of the files and the amount of memory used. Refer to [Figure 8-22](#).

Figure 8-22

FREQUENCY		AMPLITUDE		List Load/Store	
6.000 000 000 00 GHz		-144.00 dBm		Load From Selected File	
Catalog of FIR Files in Int Storage		30MB used 468MB free		Store To File	
File Name		Type	Size	modified	
1	FIR_1	FIR	260	02/20/07	12:46
2	FIR_2	FIR	28	02/20/07	12:46
Delete File					
Goto Row					
02/20/2007 12:47					

These keys manage the table of DMOD files in internal storage.

Catalog displays FIR files that have been previously saved by the user.

For details on each key, use key help as described on [page 42](#).

Memory is also shared by instrument state files and list sweep files.

This filter can now be used to customize a modulation format or it can be used as a basis for a new filter design.

## Modifying a FIR Filter Using the FIR Table Editor

FIR filters stored in signal generator memory can easily be modified using the FIR table editor. You can load the FIR table editor with coefficient values from user-defined FIR files stored in non-volatile memory or from one of the default FIR filters. Then you can modify the values and store the new files.

## Loading the Default Gaussian FIR File

Figure 8-23 Loading the Default Gaussian FIR File

Mode > Dual ARB > Arb Setup > More > Real-Time Modulation Filter

For details on each key, use key help as described on [page 42](#).

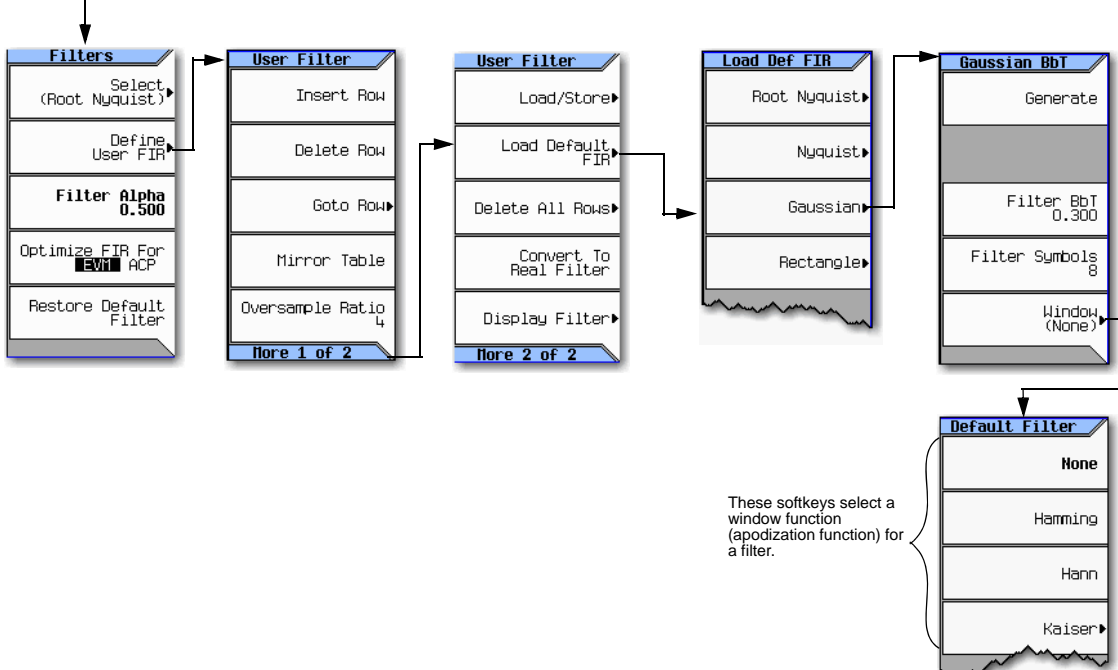

1. Press **Preset**.
2. Press **Mode > Dual ARB > Arb Setup > More > Real-Time Modulation Filter > Define User FIR > Gaussian**.
3. Press **Filter BbT > 0.300 > Enter**.
4. Press **Filter Symbols > 8 > Enter**.
5. Press **Generate**.

**NOTE** The actual oversample ratio during modulation is automatically selected by the instrument. A value between 4 and 16 is chosen dependent on the symbol rate, the number of bits per symbol of the modulation type, and the number of symbols.

6. Press **Display Impulse Response** (refer to [Figure 8-24](#)).

Figure 8-24

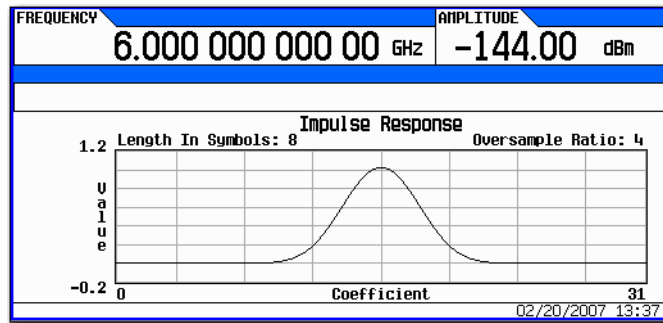

For details on each key, use key help as described on page 42.

7. Press **Return**.

### Modifying the Coefficients

1. Using the front panel arrow keys, highlight coefficient 15.
2. Press **0 > Enter**.
3. Press **Display Impulse Response**.

Figure 8-25

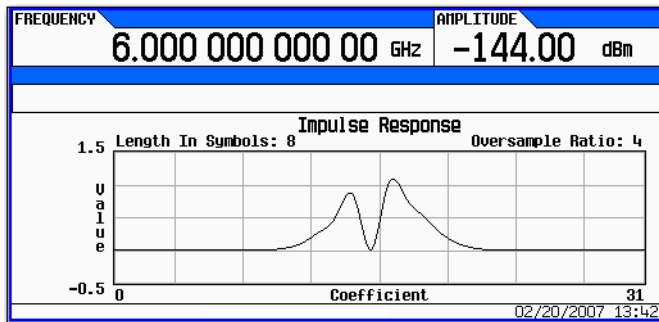

For details on each key, use key help as described on page 42.

Refer to [Figure 8-25 on page 217](#). The graphic display can provide a useful troubleshooting tool (in this case, it indicates that a coefficient value is missing, resulting in an improper Gaussian response).

4. Press **Return**.
5. Highlight coefficient 15.
6. Press **1 > Enter**.

## Storing the Filter to Memory

The maximum file name length is 23 characters (alphanumeric and special characters).

1. Press **Load/Store > Store To File**.
2. Name the file NEWFIR2.
3. Press **Enter**.

The contents of the current FIR table editor are stored to a file in non-volatile memory and the catalog of FIR files is updated to show the new file.



## Setting the Real-Time Modulation Filter

The real-time modulation filter effectively compresses a single carrier I/Q waveform down to just the I/Q constellation points and then controls the transitions similar to the modulation filter in Arb Custom modulation. The key difference is that this filter is applied as the waveform plays, rather than in the waveform data itself. The real-time modulation filter is only available for Dual ARB waveforms.

When the real-time modulation filter is on, the sample clock rate acts as the symbol rate. The sample clock rate must be set to one half of the sample rate for the real-time Arb modulation filter feature to be turned on. The sample rate is determined by the Option 65x loaded in

**CAUTION** Because the Arb format only supports rectangular I/Q data for defining the symbol decision points, constant envelope modulation, which should be specified as magnitude and phase, are not supported. (Examples of constant envelope modulation are MSK and FSK.)

The carrier frequency must be the same for all frequencies used (i.e. only single carrier applications work with arb real-time modulation filters).

**Figure 8-26 Real-Time Modulation Filter Softkey for the Dual ARB Player**

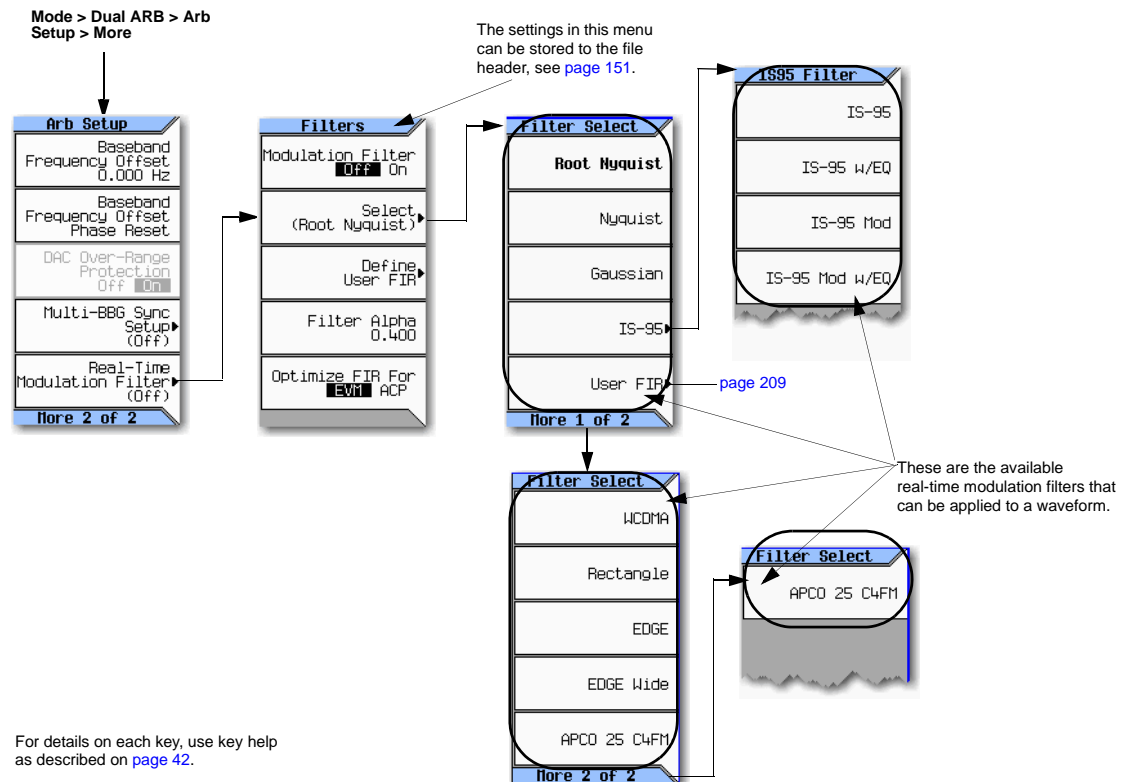

Common uses for the real-time modulation feature include:

- Where the single carrier rectangular ideal I/Q symbol decision points are known and are to have an over-sampled filter applied.
- Where greater effective MXG memory size is required.
- When you have a low rate waveform that could benefit from a higher OSR that does not make the waveform longer.

The real-time modulation filter setup is one of the file header parameters ([page 151](#)), which means you can store this setup with the waveform. When you select a waveform with a stored modulation filter setup, the signal generator changes the current setup to match the stored file header setup. If there is no stored modulation filter setup for the current waveform, the signal generator uses the last set modulation filter setup.

You can also use the Save function ([page 70](#)) to store this value as part of the signal generator setup. When you Recall a setup stored with the Save function, the modulation filter value becomes the current instrument setting value, disregarding the stored file header value.

Use the following steps to apply a real-time modulation filter to the current waveform loaded into volatile memory. This example uses the factory supplied waveform, SINE\_TEST\_WFM available in the Dual ARB Player. To view the output for this example, connect the RF OUTPUT of the signal generator to the input of a spectrum analyzer.

---

**NOTE** The following setup assumes you have completed the setup in “[Setting the Baseband Frequency Offset](#)” on [page 196](#) for creating a modulated RF signal that is offset from the carrier frequency by 20 MHz.

---

1. Configure the modulation filter:

Press **Mode > Dual ARB > Arb setup > More > Real-Time Modulation Filter > Select > Root Nyquist**

2. Press **Filter Alpha > .4 > Enter**.

The modulated RF signal now has a real-time modulation filter of type root nyquist, with a filter alpha of 0.400.

## Multiple Baseband Generator Synchronization

Available in the Dual ARB menu, this feature lets you set up a master/slave system of up to sixteen Agilent MXGs so that the baseband generators (BBG) synchronize the playing of waveforms. The system count includes one Agilent MXG to function as the master (see “[Equipment Setup](#)” on [page 224](#)).

The MXG with Option 012, enables 2x2, 3x3, or 4x4 MIMO configurations to share a common external LO signal to create phase coherent system. Refer to “[Understanding Option 012 \(LO In/Out for Phase Coherency\) with Multiple Baseband Generator Synchronization](#)” on [page 227](#) and the *Data Sheet*.

**Figure 8-27 Multiple Baseband Generator Synchronization (BBG Synchronization) Trigger Softkeys and Menu Location**

**Note:** The BBG sync feature automatically configures the trigger settings shown below. To avoid a settings conflict error in this process, manually configure the trigger settings prior to setting the BBG sync parameters shown on page 222.

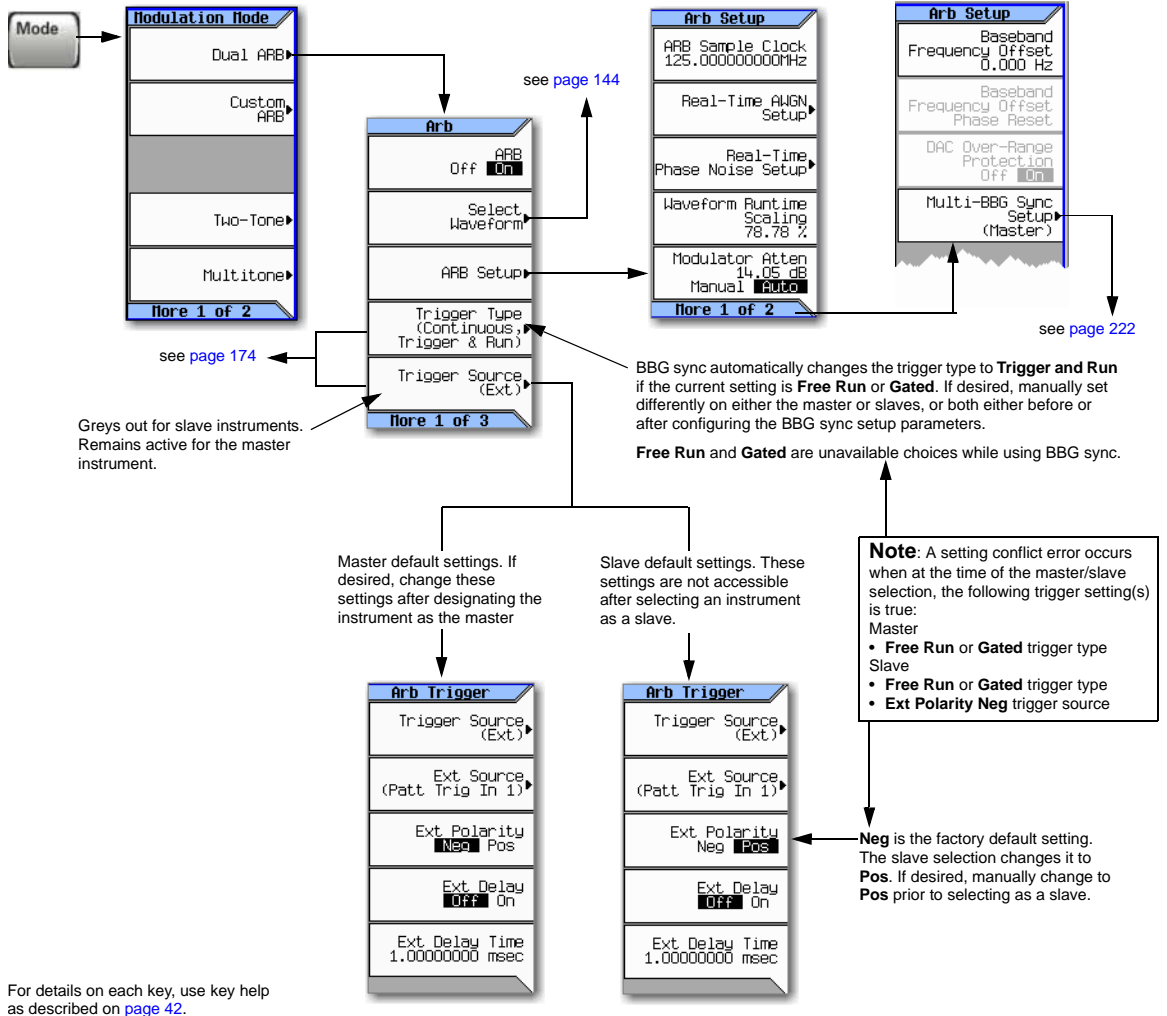

Figure 8-28 Multiple BBG Synchronization Front Panel Displays

Master Display and Available Softkeys

Master/slave indicator and setup diagram.

Master shows one of the following messages:

- Out of Sync
- In Sync

Shows after pressing **Sync Slaves**

Select **Off**, **Master**, or **Slave**

This is a persistent setting that survives both preset and cycling the power.

Grayed-out on master, active for slaves.

Synchronizes the baseband generators for all instruments in the system.

**Note:** Press only after pressing **Listen for Sync** on all slave instruments and the slaves show "Waiting For Sync" as the status.

Slave Display and Available Softkeys

Master/slave indicator and setup diagram. The bottom slave indicator is green on the last slave in the system.

Slave shows one of the following messages:

- Out of Sync
- Waiting for Sync
- In Sync

Shows after pressing **Listen for Sync**

Shows after pressing **Sync Slaves** on the master

Select **Off**, **Master**, or **Slave**

These are persistent settings that survive both preset and cycling the power.

After pressing, the slave waits for the synchronization signal initiated by the master.

**Note:** Press before pressing **Sync Slaves** on the master instrument.

For details on each key, use key help as described on [page 42](#).

## Understanding the Master/Slave System

### System Delay

The multiple BBG synchronization feature provides a system for synchronizing the waveform generation capability of up to 16 signal generators to within a characteristic value of  $\pm 8$  ns between the master and the last slave. This minor amount of delay ( $\pm 8$  ns) can be reduced further to picosecond resolution by using the **I/Q Delay** softkey located in the **I/Q** menu. To reduce the delay, check and adjust the BBG signal alignment for each signal generator in the system. For more information on adjusting the delay, see [“I/Q Adjustments” on page 203](#).

The delay value includes compensation for cables that have less than 1 ns of propagation delay between the **EVENT 1** and **PAT TRIG** connectors (see [Equipment Setup](#)). The recommended cable is an Agilent BNC cable, part number 10502A. The use of cables with greater propagation delay may not allow the signal generators to properly synchronize.

### System Synchronization

Synchronization occurs after the master signal generator sends a one-time event pulse that propagates through and to each slave in the system. Prior to this event, each slave must recognize that it is waiting for this event pulse, which occurs during the system configuration (see [“Configuring the Setup” on page 224](#)). In order to properly send the synchronization pulse, the trigger source and the Dual ARB Player for each signal generator must be turned off.

The master/slave setup does *not* incorporate a feedback system between the slaves and the signal generator selected as the master. After synchronization, if changes occur to the Multi-BBG Sync Setup menu or a signal generator is added to the system, the master does not automatically resynchronize the setup. This may cause the signal generators in the system to incorrectly report their status as In Sync.

The system can also misinterpret other signals as the synchronization pulse, which results in an incorrect In Sync status. These types of signals include a continuous trigger or an active Marker routed to the EVENT 1 connector. Improperly connected rear panel cables can also create a false status.

You must resynchronize the entire system after making any change in one or all of the Multi-BBG Sync Setup menus, after adding a signal generator to the system, or in doubt as to the true status of a signal generator. Changes to parameters that are outside of the Multi-BBG Sync Setup menu such as waveform files, Dual ARB state, sample rate, scaling, carrier frequency or amplitude have no effect on the system synchronization. To resynchronize a system, see [“Making Changes to the Multiple Synchronization Setup and Resynchronizing the Master/Slave System” on page 226](#).

### System Trigger Setup

The multiple BBG synchronization feature restricts the trigger selections (see [page 221](#)) for each signal generator. For signal generators selected as slaves, you can only modify the trigger type (with restrictions). The trigger source is fixed and set to receive a trigger through the rear panel **PAT TRIG** connector. On the master, you can change both the trigger type (with restrictions) and the trigger source. The trigger source provides three options for triggering the waveforms: external trigger, front panel **Trigger** key, or the GPIB trigger.

If the trigger settings are other than what the BBG synchronization feature supports, the feature changes the trigger settings to what is shown on [page 221](#). When this change occurs, the Agilent MXG generates a settings conflict error to alert you to the changes. To avoid the error generation,

appropriately configure the trigger settings prior to selecting a signal generator as the master or slave.

The system trigger propagates in the same manner as the synchronization pulse initiated by the master (see [System Synchronization](#)). So if it is not turned off during changes to the synchronization parameters, it can cause a false In Sync status.

The signal generator does not reset the trigger parameters when the multiple BBG synchronization feature is turned off. To play waveforms after disabling the feature, you must either set the trigger type to **Free Run** or provide a trigger to start the waveform play back.

## Equipment Setup

**Figure 8-29 Multiple Baseband Synchronization Setup**

**Note:** To minimize synchronization delay, the Agilent BNC cable 10502A is the recommended cable for the rear panel daisy chain connections (see [page 223](#)).

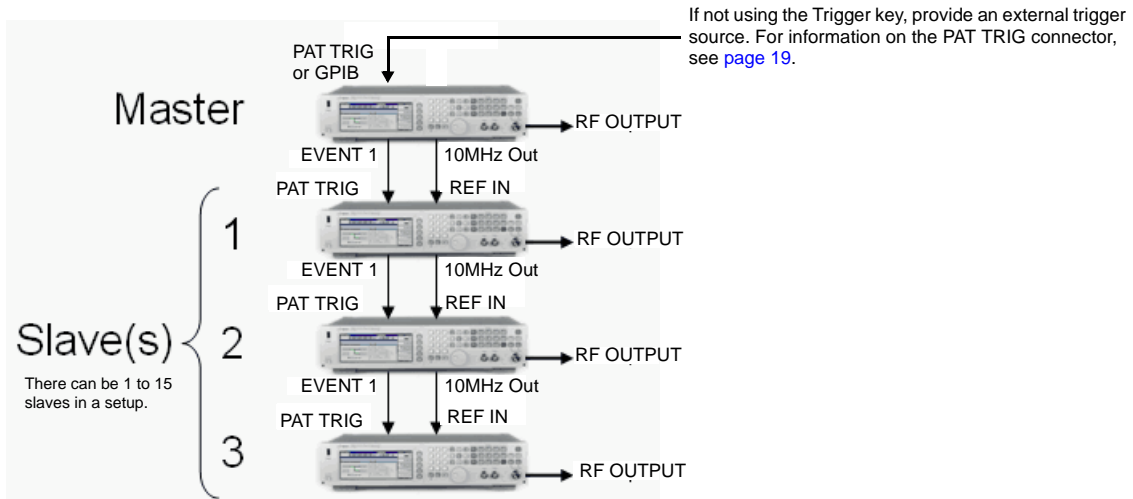

## Configuring the Setup

### Set the Common Parameters

Perform the following steps on all signal generators:

1. Set the frequency of the carrier signal.
2. Set the power level of the carrier signal.
3. Select the desired waveform (see [page 144](#)).

Do *not* turn the Dual ARB on.

4. Except for triggering, set the desired waveform parameters such as markers and sample clock.  
The baseband synchronization feature limits the trigger selections for both the master and slaves. If the current trigger settings include unsupported BBG synchronization parameters, the Agilent MXG generates a settings conflict error and changes the trigger settings. To avoid the settings conflict error, manually set the trigger parameters as shown on [page 221](#) prior to setting the multiple BBG synchronization parameters.
5. Turn on the RF Output.

#### Set the BBG Synchronization Master Parameters

1. Press **Mode** > **Dual ARB** > **ARB Setup** > **More** > **Multi-BBG Sync Setup** > **Multi-Bbg Sync Type** > **Master**.
2. Set the number of slaves using the **Number of Slaves** softkey.
3. If desired, modify the trigger parameters (see [page 221](#)).  
The master signal generator allows the modifications of both the trigger type and the trigger source.
  - a. Return to the Dual ARB menu (see [page 221](#)).
  - b. Set the desired trigger type and source.
  - c. Return to the **Multi-BBG Sync Setup** menu.

#### Set the BBG Synchronization Slave Parameters

1. Press **Mode** > **Dual ARB** > **ARB Setup** > **More** > **Multi-BBG Sync Setup** > **Multi-BBG Sync Type** > **Slave**.
2. Set the number of Slaves using the **Number of Slaves** softkey.
3. Set the slave position that the signal generator occupies.  
There can be up to fifteen slaves in a system.
4. Press the **Listen for Sync** softkey and verify that Waiting for Sync appears in the Status area of the display.
5. If desired, select a different trigger type parameter:
  - a. Return to the Dual ARB menu (see [page 221](#)).
  - b. Set the desired trigger type.
  - c. Return to the **Multi-BBG Sync Setup** menu.
6. Repeat for each slave signal generator in the system.

#### Synchronize the System

Perform this procedure only after setting the parameters for both the master and slave signal generators. If resynchronizing a system, use the procedure [“Making Changes to the Multiple Synchronization Setup and Resynchronizing the Master/Slave System”](#) on [page 226](#).

1. On the master, press the **Sync Slaves** softkey.

---

**NOTE** All of the signal generators in the master/slave system must be resynchronized when any changes are made to the master/slave settings or with the addition of a slave instrument, even if In Sync appears after pressing the **Listen for Sync** softkey on the slave instruments.

---

2. On the front panel displays, ensure that all of the signal generators show In Sync as the Status.

#### **Trigger and Play the Waveform**

1. On all Agilent MXGs, press **Mode > Dual ARB > ARB Off On** to On.
2. Start the trigger signal going to the master signal generator.

### **Making Changes to the Multiple Synchronization Setup and Resynchronizing the Master/Slave System**

If any changes are made to the master/slave parameters or a signal generator (slave unit) is added to the system, the system must be resynchronized even if In Sync appears in the Status portion of the display.

1. Turn off the trigger source. If using the **Trigger** key, there is nothing to turn off.  
If the trigger source is on and provides a continuous pulse stream, it may cause the signal generators to incorrectly display In Sync as the status after pressing the **Listen for Sync** softkey.
2. On each of the signal generators, press **Mode > Dual ARB > ARB Off On** to Off.  
If a signal generator(s) has the Dual ARB on during changes, signal generators further in the chain may incorrectly display In Sync after pressing the **Listen for Sync** softkey.
3. On each of the signal generators, press **ARB Setup > More > Multi-BBG Sync Setup**.
4. Make the changes in the Multi-BBG Sync Setup menu.  
Out Of Sync appears as the status message.
5. On each of the slave signal generators, press **Listen for Sync**.
6. Ensure that all of the slaves' Status show Waiting for Sync. If In Sync shows as the status, perform the following steps:
  - a. Check that the **PATT TRIG** to **EVENT 1** cables are properly connected on the rear panel.  
A disconnected cable can cause a false In Sync status.
  - b. If the cables are connected, perform steps 1 and 2.
  - c. Press **Listen for Sync** and ensure that Waiting for Sync appears as the status.
7. On the master signal generator, press **Sync Slaves**.
8. Verify that In Sync appears as the status on all master/slave signal generators.
9. Perform the process "[Trigger and Play the Waveform](#)" on page 226.



## Understanding Option 012 (LO In/Out for Phase Coherency) with Multiple Baseband Generator Synchronization

---

**NOTE** This section assumes that the previous section on Multiple Baseband Generator Synchronization has been read and understood. If not, refer to “[Multiple Baseband Generator Synchronization](#)” on page 220 before continuing.

---

The MXG with Option 012, enables 2x2, 3x3, or 4x4 MIMO configurations to share a common external LO signal to create a phase coherent system (refer also, to “[Multiple Baseband Generator Synchronization](#)” on page 220).

RF phase coherency may *not* be needed for general STC/MIMO receiver testing, since a MIMO receiver perceives any phase differences between the sources as part of the channel conditions and correct for them. But, RF phase coherency might be desirable for certain applications such as R&D on beamforming systems.

### Configuring the Option 012 (LO In/Out for Phase Coherency) with MIMO

The Agilent BNC cable, part number 10502A, is the recommended cable for the standard multi-BBG synchronization setup, and is recommended for Option 012 too (see also [Figure 8-29 on page 224](#)). Additionally, for the 2x2, 3x3, and 4x4 MIMO connections from the LO IN and LO OUT to the splitter, additional cables are required (refer to [Table 8-5](#), [Figure 8-30 on page 229](#), and [Figure 8-31 on page 230](#)).

---

**NOTE** Agilent recommends the LO Output be covered when not in use.

When the LO In/Out jumper cable is removed and the instrument is in Dual ARB mode, the instrument is unlevelled and the instrument displays an Unlevel error message.

All test equipment requires a 12 hour warm-up period to ensure accurate performance.

---

The phase coherent configuration requires the following:

- The recommended LO input drive level should be in the 0 to 6 dBm range.

---

**NOTE** The 0 to 6 dBm LO input drive level ensures the instruments will operate over the full frequency and over the full 0 to 55 ambient temperature range<sup>1</sup>.

---

- The I/Q calibration and the self-test must be performed with the LO In/Out jumper cable in place. Where the I/Q calibration cannot be run, the baseband offset can be manually adjusted to minimize the I/Q offsets.
- The phase coherency feature only applies to the Dual ARB modulation mode.
- All cables from the splitter output to the instrument inputs should be of equal lengths.

---

<sup>1</sup>LO input power requirements vary with temperature; power <0 dBm may work at 20–30 degree ambient temperature conditions. Refer to the *Data Sheet*.

**Table 8-5 Option 012 (LO In/Out for Phase Coherency) Equipment**

MIMO Configuration	Part <sup>a</sup>	Cable Length	Notes
2x2	n/a	As required	SMA flexible cables are connected from the power splitter outputs to the LO inputs on the rear panel of both the master and the slave MXGs. Refer to <a href="#">Figure 8-30 on page 229</a> .
	11636A	n/a	Power Divider, DC to 18 GHz. Refer to <a href="http://www.agilent.com">www.agilent.com</a> .
3x3	n/a	As required	SMA flexible cables are connected from the power splitter outputs to the LO inputs on the rear panel of the slave MXGs. Refer to <a href="#">Figure 8-31 on page 230</a> .
	PS3-20-451/12 S	n/a	3-Way Pulser Microwave Corp., 3-Way Wilkinson Dividers
4x4	n/a	As required	The SMA flexible cables are connected to the power splitter output to the LO inputs on the rear panel of the slave MXGs. Refer to <a href="#">Figure 8-31 on page 230</a> .
	PS4-16-452/10 S	n/a	4-Way Pulser Microwave Corp., 4-Way Wilkinson Dividers
All	10502A	22.86 cm (9 inches)	Refer to <a href="#">Figure 8-30 on page 229</a> and <a href="#">Figure 8-31 on page 230</a> . See also "Multiple Baseband Generator Synchronization" on page 220.

<sup>a</sup>On all of the MIMO configurations, the same length of SMA flexible cables are connected from the splitter output to the inputs on the master and slave instruments. Refer to [Figure 8-30 on page 229](#) and to [Figure 8-31 on page 230](#).

### 2x2 MIMO (LO In/Out for Phase Coherency) Configuration

For the 2x2 MIMO (LO In/Out for phase coherency) setup, the LO from the master MXG can be ran through a power splitter and used as the LO input to both the master and the slave MXGs. No external source is required.

To generate phase coherent signals for a 2x2 MIMO configuration, the master MXG LO OUT is connected via a power splitter to the slave LO IN. The LO OUT provides a sufficient amplitude LO signal when connected directly, to drive the Slave MXG(s), thus providing phase coherency for the RF output signals. In this example, we show two MXG signal generators with Option 012 connected for a phase coherent 2x2 MIMO solution. Refer to [Figure 8-30](#).

**Figure 8-30 2x2 MIMO (LO In/Out for Phase Coherency) Equipment Setup**

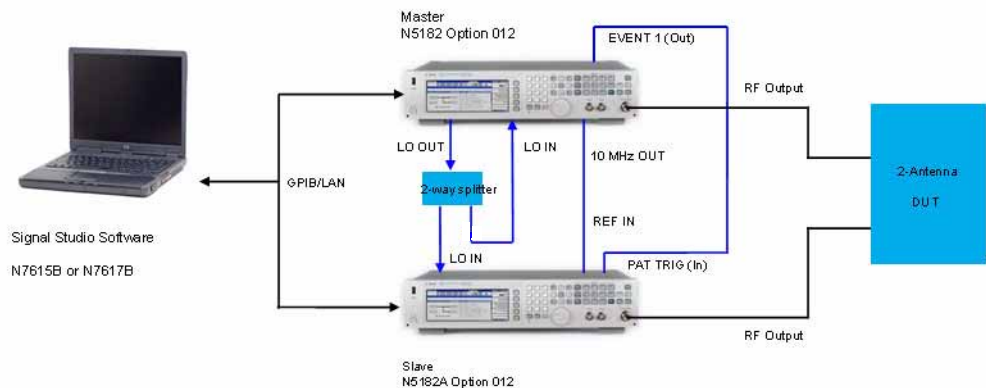

**Note:**

To optimize the phase coherence, the same length SMA flexible cable is recommended for the *output* of the 2-way splitter connections to the LO IN of the MXGs with Option 012 (see [page 227](#)).

To minimize synchronization delay, the Agilent BNC cable 10502A is the recommended cable for the rear panel daisy chain

### 3x3 and 4x4 MIMO (LO In/Out for Phase Coherency) Configurations

For a 3x3 and 4x4 MIMO (LO In/Out for phase coherency) setups, an additional analog source is needed to provide the higher LO power required by the power splitter and the additional instruments.

Splitting the LO output four ways causes too much loss to drive the LO input of the N5162/82As in the system. Also, there is no amplitude adjustment to the LO output of the N5162A/82A. To generate phase coherent signals for a 3x3 and 4x4 configurations with the MXG, an external Master LO is needed to provide a sufficient amplitude LO input signal to the vector MXGs (refer to [Figure 8-31 on page 230](#)).

---

**NOTE** The Master LO is *not* controlled by any of the *Signal Studio* software, but must be set *manually*—via the RF frequency settings on the master MXG—by the user to the desired frequency and amplitude.

---

**Figure 8-31 3x3 and 4x4 MIMO (LO In/Out for Phase Coherency) Equipment Setup**

**Note:**

A SMA flexible cable is recommended for the *input* to the 4-way splitter connections to the LO IN and LO OUT of the MXGs with Option 012 (see [page 227](#)).

To optimize the phase coherence, the same length SMA flexible cable is recommended for the *output* of the 4-way splitter connections to the LO IN of the MXGs with Option 012 (see [page 227](#)).

To minimize synchronization delay, the Agilent BNC cable 10502A is the recommended cable for the rear panel daisy chain

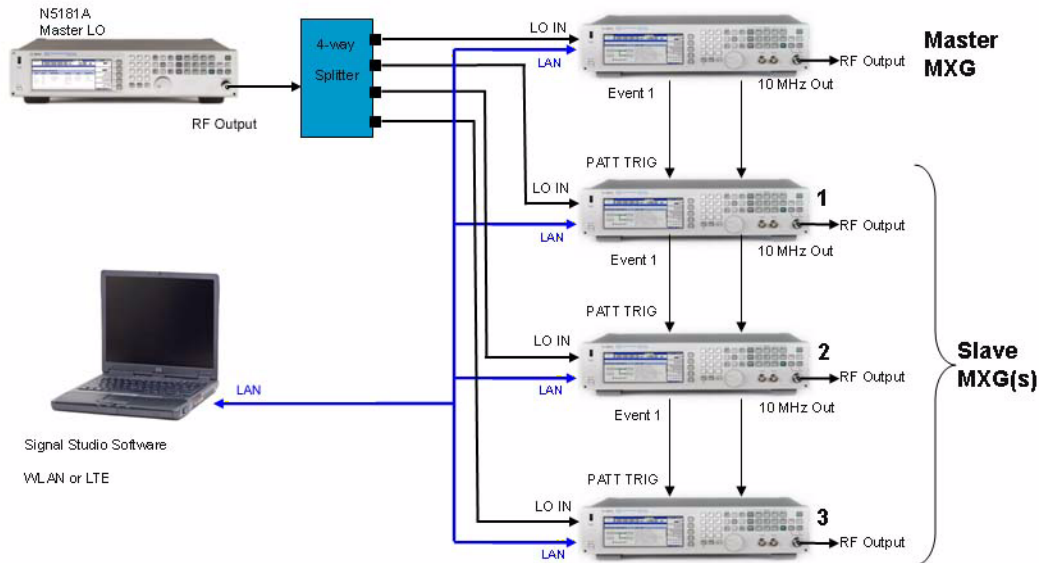

## Waveform Licensing for Firmware Version $\geq$ A.01.50

Waveform licensing enables you to license waveforms that you generate and download from any Signal Studio application for unlimited playback in a signal generator. Each licensing option (221-229) allows you to permanently license up to five waveforms or (250-259) allows you to permanently license up to 50 waveforms of your choice (i.e. Waveform Option 22x or Option 25x are *perpetual fixed* waveform licenses).

Waveforms licensed with Options 221-229 or Options 250-259 cannot be exchanged for different waveforms. Once a waveform is licensed, that license is permanent and cannot be revoked or replaced. Option 22x and 25x waveform licenses are signal generator specific (i.e. signal generator serial number specific). If a licensed Option 22x or Option 25x waveform file is transferred to another signal generator, the file must be licensed by a separate Option 22x or Option 25x that is in the other signal generator *before* it can be played.

To redeem Option 22x or Option 25x, refer to the *N5182A-2xx Entitlement Certificate* that comes with the N5182A-2xx order. For more information on extracting and downloading waveform files, refer to the *Programming Guide*.

### Understanding Waveform Licensing

Use any N76xxB Signal Studio software to build and download waveforms to the signal generator. Each Option 22x provides 5 available slots and Option 25x license provides 50 available slots, where you can add and play waveforms for a trial period of 48 hours per slot. During this time, you can replace the waveform any number of times until you are satisfied with it. After the trial period expires, the waveform in the slot is no longer playable until the slot is locked for permanent playback; however, you can replace the waveform in the slot with another waveform of your choice before locking the slot.

To license additional waveforms that exceed the number permitted by an Option 22x or Option 25x, you must purchase another Option 22x or Option 25x that you do *not* already own. For example, if you already own Option 250, purchase Option 251 to add an additional 50 slots. Adding all options, 250-259, provides a maximum of 500 slots. Adding all options, 221-229, provides a maximum of 45 slots. (Repurchasing the same option for the *same* signal generator, gives you no additional Waveform licenses.)

### Installing an Option N5182-22x or Option N5182A-25x

Load a Waveform License, Option N5182-22x or Option N5182A-25x, into the signal generator using License Manager or a USB media. For more information on loading the Waveform License, refer to the *N5182A-2xx Entitlement Certificate* included with your order.

### Licensing a Signal Generator Waveform

Create and download a waveform into the signal generator using any of the N76xxB Signal Studio software. Refer to your Signal Studio software help if you need assistance using the application.

Refer to [page 236](#) for steps in adding the waveform to a license slot for a 48-hour trial period. During the trial period, the waveform can be played and replaced any number of times. When the trial time expires, the slot can no longer be used for playback until the slot is locked for permanent playback capability.

## Waveform Licensing Softkeys Overview

**Figure 8-32 Waveform Licensing Softkeys**  
 Mode > Dual ARB > More

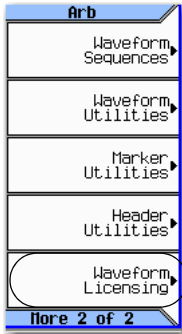

**Note:** Waveforms licensed with Option 2xx cannot be exchanged for other waveforms. Once a waveform is locked into a license slot, that license is permanent and cannot be revoked or replaced.

This softkey is only available if there is an Option 2xx license installed on the instrument. Pressing this softkey displays the licensing status and associated filename for each slot and accesses the waveform licensing menu selections.

**Note:** When Waveform Licensing is first accessed, all slots appear as **Available**. For licensing status descriptions after waveforms have been added to a slot, refer to [Table 8-6 on page 235](#).

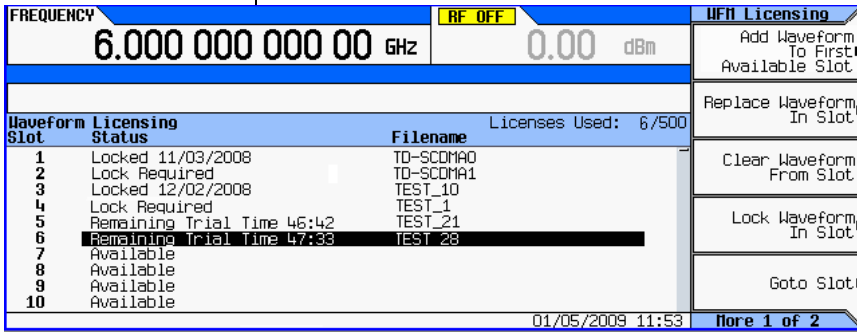

This softkey allows you to add a waveform that you select to the first available slot. Refer to [page 233](#).

This softkey allows you to replace a waveform in the selected slot. Refer to [page 234](#).

This softkey clears the waveform from the selected slot.

This softkey allows you to lock a waveform into a slot. After the trial period has expired, the waveform must be locked in order to be able to play the waveform. Refer to [page 234](#).

This softkey allows you to select a specific slot where you want to add, replace, or clear a waveform. You can also select a slot by using the front panel arrow keys or by scrolling to the slot. Refer to [page 233](#).

Refer to the SCPI Command Reference for related license commands.

[page 234](#)

For details on each key, use key help as described on [page 42](#).

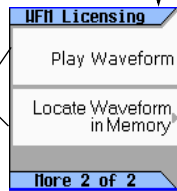

Figure 8-33 Waveform Licensing Softkeys

Mode > Dual ARB > More >  
Waveform Licensing > Add  
Waveform to First Available Slot

or

Mode > Dual ARB > More >  
Waveform Licensing > Replace  
Waveform in Slot

**Note: Waveforms licensed with Option 2xx cannot be “exchanged”. Once a slot is locked, that license for the waveform in the locked slot is permanent and cannot be revoked or replaced.**

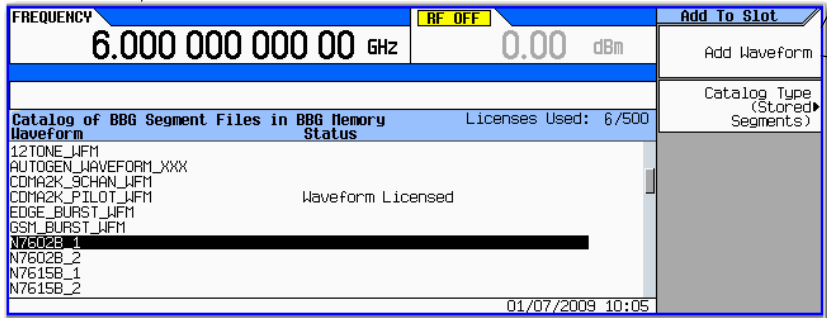

The waveform to be added or replaced can be selected from BBG memory, internal storage, or a USB device.

The softkey is greyed out, if a waveform is already licensed or does not require licensing.

To select a waveform, use the arrow keys to highlight the waveform and then press **Add Waveform**.

Refer to the SCPI Command Reference for related License Commands.

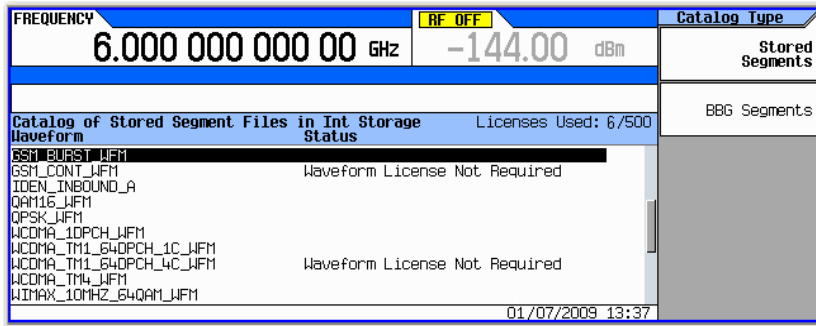

This softkey displays a catalog of the waveform segments stored in the **Int Storage** or **USB Media**.

This softkey displays a catalog of the waveforms stored in the **BBG** memory.

For details on each key, use key help as described on [page 42](#).

**Figure 8-34 Waveform Licensing Softkeys**

Mode > Dual ARB > More > Waveform Licensing  
> Lock Waveform in Slot

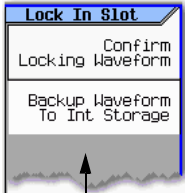

Press this softkey to confirm that you want to lock the waveform into the slot for permanent licensing. If the waveform has not been saved to internal storage, a warning message appears. Refer to [Step 4 on page 237](#).

This softkey is displayed if the waveform is not found in the internal storage memory of the signal generator. Press this softkey to store the waveform into the Internal Storage and to activate the **Confirm Locking Waveform** softkey. Refer to [Step 4 on page 237](#).

Mode > Dual ARB > More > Waveform Licensing > Goto Slot

Refer to the SCPI Command Reference for related license commands.

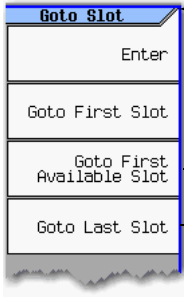

Press this softkey after entering a specific slot number using the front panel numeric pad.

Press this softkey to go to the first slot.

Press this softkey to go to the first slot whose status is available.

Press this softkey to go to the last slot. The number of slots depends on the number of licensing options installed on the instrument.

Mode > Dual ARB > More > Waveform Licensing > More > More

Waveform Slot	Licensing Status	Filename	Licenses Used: 6/500
1	Locked 11/03/2008	TD-SCDMA0	
2	Lock Required	TD-SCDMA1	
3	Locked 12/02/2008	TEST_10	
4	Lock Required	TEST_1	
5	Remaining Trial Time 46:42	TEST_21	
6	Remaining Trial Time 47:33	N75026-UFFM1	
7	Available		
8	Available		
9	Available		
10	Available		

Press this softkey to play the waveform in the highlighted slot.

Press this softkey to locate the waveform in memory that was added to this slot regardless of the name. If the search returns no results, the original waveform has been deleted from memory and cannot be found.

For details on each key, use key help as described on [page 42](#).



**Table 8-6 Waveform Licensing Slot Status Messages**

Status Column	Meaning	Notes
Available	The slot has never had a waveform added to it.	50 slots are initially available for each Option 25x. 5 slots are initially available for each Option 22x.
Locked MM/DD/YY	The slot is locked and can no longer be modified.	The waveform in this slot is licensed to this signal generator for unlimited playback.
Remaining Trial Time HH:MM	The slot is in a trial period that is available for 48 hours that begins when a waveform is added.	During the trial period, the waveform in this slot can be played, cleared, or replaced with another waveform.
Lock Required	The trial period for the slot has expired but the slot has not been locked.	The slot can be cleared or replaced with a different waveform but the waveform cannot be played until the slot is locked. A trial period is no longer available.

### Example: Licensing a Signal Studio Waveform

The following steps add a waveform file to a license slot and lock the slot for permanent playback.

1. Press **Mode > Dual ARB > More > Waveform Utilities > Waveform Licensing**

The signal generator displays a catalog of files labeled: Catalog of BBG Segment Files in BBG Memory.

2. Use the arrow keys to highlight and select the file to be licensed.
3. Press **Add Waveform** to add the selected waveform to the first available slot.

**Figure 8-35 Add Waveform**  
 Mode > Dual ARB > More > Waveform Licensing >  
 Add Waveform to First Available Slot

Status area for the waveform N7602B-WFM1 is empty and the **Add Waveform** softkey is active, indicating the waveform is licensable.

page 233

The selected waveform is added to the first available slot. The trial time for the slot begins as soon as the waveform is added.

During the 48 hour trial period, the waveform can be played and replaced any number of times.

When the trial time expires, the licensing status of the slot changes to **Lock Required** after which the waveform can no longer be played until the slot is locked.

Waveform Slot	Licensing Status	Filename
1	Locked 11/03/2008	TD-SCDMA0
2	Lock Required	TD-SCDMA1
3	Locked 12/02/2008	TEST_10
4	Lock Required	TEST_1
5	Remaining Trial Time 46:42	TEST_21
6	Remaining Trial Time 47:33	N7602B-WFM1
7	Available	
8	Available	
9	Available	

4. License the waveform:

- a. Press **Lock Waveform in Slot**.

A warning is displayed: **\*\*\* Waveform Lock Warning!!! \*\*\***. *If necessary, verify you have selected the correct waveform you want for licensing by pressing **Return**.*

Figure 8-36 Waveform Lock Warning



- b. Press **Confirm Locking Waveform**.

The licensing status of the slot will be changed to Locked MM/DD/YY.

- c. If the waveform has not been previously backed up in internal storage, a warning is displayed: **\*\*\* Waveform Backup Required!!! \*\*\***.

- d. Make a backup copy of this waveform on a USB media or a computer before pressing **Backup Waveform to Int Storage**. *(If the waveform is lost or deleted on the signal generator, it cannot be recovered).*

Figure 8-37 Backup Waveform To Int Storage softkey

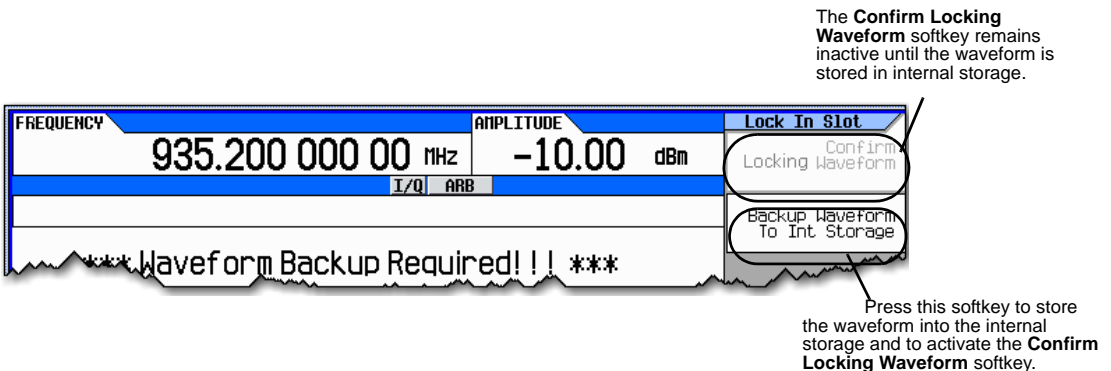

**CAUTION** It is important that you make a *backup* copy of any waveforms that you are licensing. *Do not store the backup copy on the signal generator. If all copies of the waveforms are deleted or lost, there is no way to recover the waveform or reassign the license.* Refer to [“Working with Files” on page 62](#).

### Waveform Licensing Warning Messages

Figure 8-38

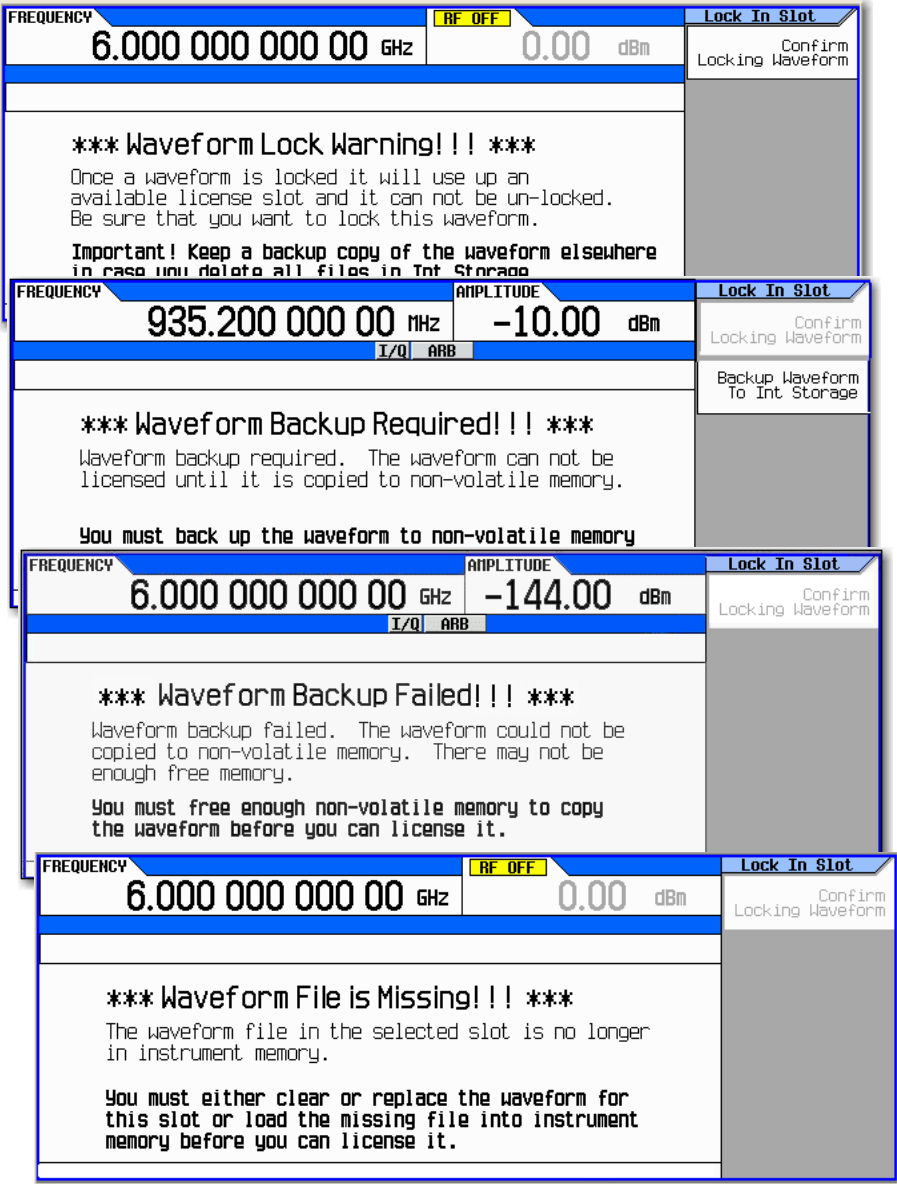

This standard warning is displayed every time a waveform is selected to be locked. This notification indicates that one of the available "license slots" is about to be used from Option 2xx.

**ALWAYS make backup copies of waveforms in a separate non-volatile memory in case a file is deleted or lost from the instrument's internal storage.**

This warning is displayed when an attempt is made to lock a waveform that has *not* been saved to internal storage or USB media (i.e. waveforms cannot be locked unless they have been stored to non-volatile memory). Press the **Backup Waveform To Int Storage** softkey.

This warning is displayed when there is insufficient memory or other problems with the internal storage, or USB media (non-volatile memory) and the waveform could not be saved to non-volatile memory.

This warning is displayed when the waveform file cannot be found in BBG or internal storage. You must ensure that the waveform still resides in the instrument before you can lock it.

## Waveform 5-Pack Licensing (Options 221–229) for Firmware Version < A.01.50

Waveform 5-Pack licensing enables you to create, generate, and permanently license up to 45 Signal Studio waveforms (e.g. Each Option 22x enables licensing of five waveforms (Option 221, 222, 223, 229).

Use the signal generator to manage the licensing of these waveforms. For example, you can use the signal generator to select individual waveforms for licensing and you can view a list of all currently licensed waveforms.

### Understanding Waveform 5-Pack Licensing

Waveforms licensed with 5-Pack cannot be *exchanged*. Once a waveform is licensed, that license is permanent and cannot be revoked or replaced. Option 22x waveform licenses are signal generator specific (i.e. signal generator serial number specific).

Waveform 5-Pack licensing enables you to create and generate signals which can be saved for unlimited use in a signal generator (i.e. Waveform 5-Pack Option 22x is a *perpetual fixed* waveform license).

Use the Signal Studio software to build and download waveforms to the signal generator's volatile memory to be played. When you are satisfied with the waveform, it must be stored to non-volatile memory before it can be licensed.

If a licensed Option 22x waveform file is transferred to another signal generator, the file must be licensed by a separate Option 22x that is in the other signal generator *before* it can be played. For more information on extracting and downloading waveform files, refer to the *Programming Guide*.

To license additional waveforms that exceed the number permitted by an Option 22x, you must purchase an Option 22x that you do *not* already own. For example if you already own Option 221 with only two remaining licenses and you need ten more waveforms, purchase Options 222 and 223 to have enough licenses to license ten more waveforms. This would leave two remaining licenses on Option 223. (Repurchasing Option 221 a second time, for the *same* signal generator, gives you no additional Waveform 5-Pack licenses.)

After licensing a waveform, you can make copies of the waveform using different file names for use on the same signal generator and even rename the original file without affecting the waveform license.

You can also use the Option 22x to license waveforms from N76xxB Signal Studio software downloaded during its 14-day free trial license. All of the N76xxB Signal Studio software products provide a 14-day trial period (trial license). This 14-day trial license lets you download and play back waveforms during the trial period. These waveforms are denoted by the TRL in the status message area of the waveform segment catalog. After the trial period expires, the TRL message is removed but the waveform remains. You can license these waveforms after the TRL message is gone.

Waveform 5-Pack requires firmware version  $\geq$ A.01.20.

### Installing an Option N5182A–22x Waveform 5-Pack Licensing

- Load a Waveform 5-Pack license, Option N5182A–22x, into the signal generator using License Manager or a USB media. For more information on loading the Waveform 5-Pack License, refer to the *N5182A–22x Entitlement Certificate*.

## Licensing a Signal Generator Waveform File

1. Create the waveform:
  - a. Download any of the N76xxB Signal Studio software that interest you. For downloading N76xxB Signal Studio software, refer to the N5182A–22x Entitlement Certificate.
  - b. Create and download a waveform to a signal generator using any of the N76xxB Signal Studio software. Refer to your *Signal Studio* software Help.

## Waveform 5-Pack Licensing Softkeys Overview

Figure 8-39 Waveform 5-Pack licensing Softkeys

Mode > Dual ARB > More >  
Waveform Utilities >

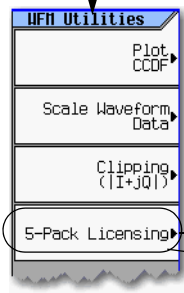

Note: Waveforms licensed with 5-Pack cannot be “exchanged”. Once a waveform is licensed, that license is permanent and cannot be revoked or replaced.

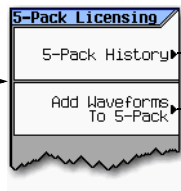

This softkey is only available if there is an Option 22x installed on the instrument.

page 247

page 241

For details on each key, use key help as described on page 42.

**Figure 8-40 Add a Waveform to 5-Pack Softkeys**

Mode > Dual ARB > More >  
Waveform Utilities > 5-Pack  
Licensing > Add Waveforms to  
5-Pack

**Note: Waveforms licensed with 5-Pack cannot be “exchanged”. Once a waveform is licensed, that license is permanent and cannot be revoked or replaced.**

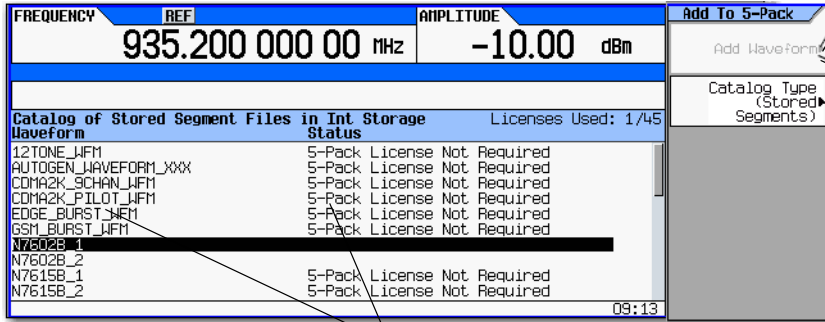

Displays the name of the Waveform file and status. Refer to Table 8-7 on page 242.

This softkey is only active when there are secure waveforms that can be added and a Waveform 5-Pack license with available slots (i.e. if a waveform is already licensed or does not require licensing the softkey is greyed out). Refer to page 245.

To select a waveform to receive one of your Waveform 5-Pack licenses, use the arrow keys to highlight the waveform and then press **Add Waveform**.

Refer to the SCPI Command Reference for related 5-Pack License Commands.

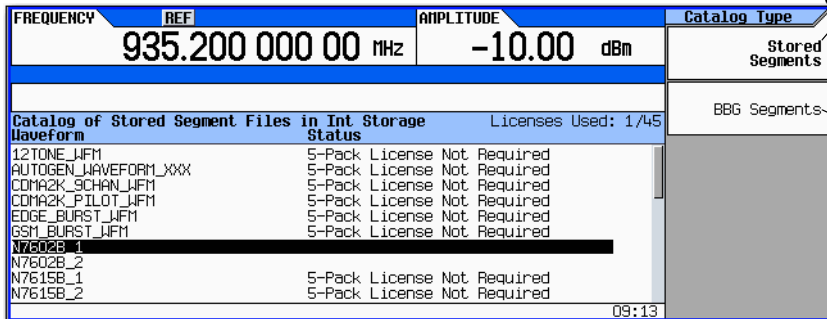

This softkey displays a catalog of the waveform segments stored in the **Int Storage** or **USB Media**.

This softkey displays a catalog of the waveforms stored in the **BBG** memory.

For details on each key, use key help as described on page 42.

**Table 8-7 Waveform 5-Pack Licensing Status Messages for the “Catalog of Segment Files in Int Storage [or USB Media]”**

Status Message	Meaning	Notes
<i>Empty field</i>	If no status message, then the waveform is licensable.	<p>Once a Trial (TRL) license expires, the waveform becomes licensable (i.e. the status message for the TRL waveform becomes an <i>empty field</i>).</p> <p>If a licensed Option 22x waveform file is downloaded to <i>another</i> N5182A signal generator, the waveform becomes licensable on that <i>other</i> signal generator (i.e. the status message field is <i>empty</i>).</p>
5-Pack Licensed	This waveform is licensed by Option 22x.	
5-Pack License Not Required	<p>This status message applies to:</p> <ul style="list-style-type: none"> <li>Any free waveforms provided with the Agilent MXG (e.g. RAMP_TEST_WFM, and SINE_TEST_WFM, etc.)</li> <li>Any customer created waveform</li> <li>Any waveforms that have a valid license (e.g. Trial (TRL) licenses, Advanced Design System (ADS), etc.).</li> </ul>	<p>Once a Trial (TRL) license expires, the waveform becomes licensable (i.e. the status message for the TRL waveform becomes an <i>empty field</i>).</p> <p>If a licensed Option 22x waveform file is downloaded to <i>another</i> N5182A signal generator, the waveform becomes licensable on that <i>other</i> signal generator (i.e. the status message field is <i>empty</i>).</p>



### Example: Licensing a Signal Studio Waveform

The following steps add a single waveform file, to a Waveform 5-Pack license. Refer to [Figure 8-42 on page 245](#).

2. There are two methods to save a waveform to the internal memory:

---

**NOTE** Before you can license a waveform with the Waveform 5-Pack licensing, the waveform must be saved in either the internal storage or the USB media.

---

- a. Save the file to internal storage using the **Backup Waveform To Int Storage** softkey:
  1. Press **Return > Return > More > Waveform Utilities > 5-Pack Licensing > Add Waveforms to 5-Pack**.
  2. Press **Backup Waveform To Int Storage** (refer to [Figure 8-41](#)).

Figure 8-41 Backup Waveform To Int Storage softkey

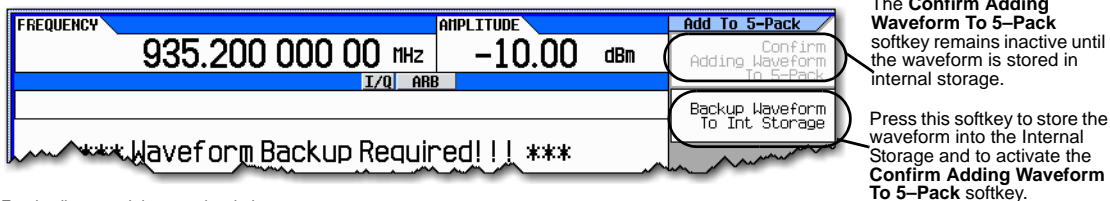

3. Go to step 3 (sub-step d).
- b. If the waveform has *already* been stored in the signal generator using the **Backup Waveform to Int Storage** softkey then proceed to [Step d](#).
  1. Otherwise use the ARB Segments menu Load **Store** softkey to store the waveform to internal storage. Refer to [“Working with Files” on page 62](#).
  2. Proceed to [Step 3](#) once you’ve stored the waveform to internal storage (internal media).
3. License the waveform:

- a. Press **Return > Return > More > Waveform Utilities > 5-Pack Licensing > Add Waveforms to 5-Pack**.

The signal generator displays a catalog of files labeled: Catalog of BBG Segment Files in BBG Memory.

- b. Use the arrow keys to highlight and select the file to be licensed.
- c. Press **Add Waveform**.

A warning is displayed: **\*\*\* Waveform Licensing Warning!!! \*\*\***. *If necessary, verify you have selected the correct waveform you want for licensing by pressing **Return***. Otherwise continue to the next step (refer to [Figure 8-42 on page 245](#)).

- d. Press **Confirm Adding Waveform to 5-Pack**.

The display returns to the Catalog of BBG Segment Files in BBG Memory and the file’s Status column is now labeled 5-Pack Licensed (refer to [Figure 8-42 on page 245](#)).

- e. Make a backup copy of this waveform on a USB media or a computer (*If the waveform is lost or deleted on the signal generator it cannot be recovered*).

---

**CAUTION** It is important that a *backup* copy is made of any 5-Pack waveforms; the backup copy must be stored on a computer or other media. *Do not store the backup copy on the signal generator. If all of the copies of the waveforms are deleted or lost, then there is no way to recover the waveform or reassign the license.* Refer to [“Working with Files”](#) on page 62.

---

**Figure 8-42 Add Waveform to 5-Pack Softkey**

Mode > Dual ARB > More >  
Waveform Utilities > 5-Pack  
Licensing > Add Waveforms to  
5-Pack

Status area for the waveform N7602B-WFM1 is empty and the **Add Waveform** softkey is active, indicating the waveform is licensable.

**Important!** Always backup licensed waveforms in a separate place from the instrument (e.g. computer, USB media, etc.).

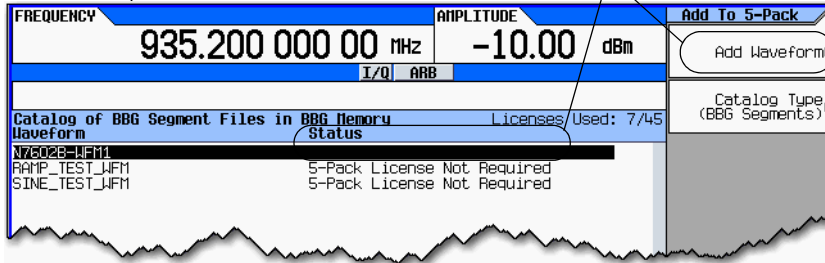

If the waveform selected for licensing has been verified as the waveform you want to be licensed, press **Confirm Adding Waveform To 5-Pack**. **Caution! This step cannot be undone.**

This warning message indicates that this is the last chance for verifying that the waveform being licensed is the one you want. If the waveform selected has not been verified, press **Return** and verify the selection.

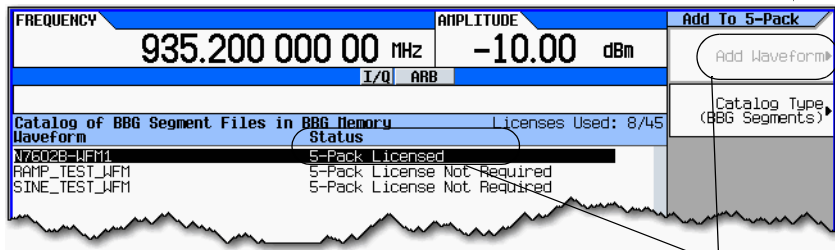
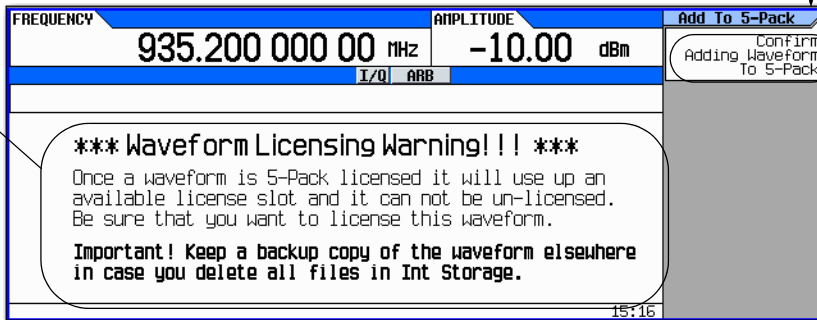

For details on each key, use key help as described on page 42.

Note that N7602B-WFM1 has a Status of "5-Pack Licensed" and the **Add Waveform** softkey is no longer active.

## Using Waveform 5-Pack History

The Waveform 5-Pack History softkeys can be used to manage the Waveform 5-Pack files on your signal generator. The 5-Pack History softkeys can be used to:

- Create a list for a specific Waveform 5-Pack licensed waveform including any *renamed* files that have been leveraged from that licensed waveform
- Create a list of all licensed and unlicensed waveforms on the signal generator

Refer to [Figure 8-43 on page 247](#), for a description of the Waveform 5-Pack History softkeys.

The **5-Pack History** softkey is only active, if you have *previously* stored a Waveform 5-Pack file in non-volatile memory (internal storage, or USB media). But, the softkey **5-Pack History** tracks the history of licensed waveform files that may no longer be available in non-volatile memory (e.g. if the waveform file has been deleted from internal storage or is located on a USB media that is *not* attached to the instrument, *the 5-Pack History softkey remains active*). 5-Pack History retains a catalog of the Redemption Date, Waveform ID, and the Original Filename.

---

**NOTE** You can display either a catalog of the Internal storage or of the USB media but *not* both at the same time.

If you switch from the internal storage to the USB media, and the instrument displays an “Error -230, Data corrupt or stale” this is typically because a file (or files) was found with the same name, but the file is a *different waveform file* (has a *different* Waveform ID) than the original 5-Pack licensed internal storage file.

---

Figure 8-43 Waveform 5-Pack History Softkeys

Mode > Dual ARB > More >  
Waveform Utilities > 5-Pack  
Licensing > 5-Pack History

Only available when there have been waveforms with Waveform 5-Pack licenses previously stored.

Pressing this softkey searches for every copy of the highlighted waveform regardless of the current filename. If the search returns no results, then the original waveform has been deleted and cannot be found.

Displays the number of waveform licenses used and the number of total waveform license 'slots' available (e.g. For this example 3 of the 45 licenses have been used).

This area displays the date the waveform was licensed, the unique Waveform ID, and Original filename at the time the waveform was first redeemed.

This screen displays all waveforms that are licensed by Option 22x.

For details on each key, use key help as described on page 42.

When you press **Find Waveform**, any copies of the originally saved waveform are displayed on the instrument (e.g. N7602B\_1\_COPY1, N7602B\_1\_COPY2, and N7602B\_1\_COPY3). In this example, the original filename N7602B\_1 was not found because the original file was deleted or the name was changed. But three copies were found (N7602B\_1\_COPY3 was found in both the Int Storage and the BBG Memory).

Location is the memory location:  
\*Int Storage  
\*BBG Memory, or  
\*USB Media

Note:  
1) In this example, the waveform N7602B\_1\_COPY3 is stored in the Int Storage and playing in the BBG Memory.  
2) In this example, the Int Storage has been selected as the non-volatile storage location. To view any 5-Pack waveforms stored on the USB media, the USB media must be selected as the default storage. Refer to page 62.

Waveform 5-Pack License History	Redemption Date	Waveform ID	Original Filename
	05/03/2007	df344ee3	N7602B_1
	05/03/2007	df362ee3	N7602B_2
	05/03/2007	df374ee3	N7602B_3

Waveform 5-Pack Search Results	Location	Current Filename	All Waveforms
	Int Storage	N7602B_1_COPY1	
	Int Storage	N7602B_1_COPY2	
	Int Storage	N7602B_1_COPY3	
	Int Storage	N7602B_2	
	Int Storage	N7602B_3	
	BBG Memory	N7602B_1_COPY3	

Waveform 5-Pack Search Results	Location	Current Filename
	Int Storage	N7602B_1_COPY1
	Int Storage	N7602B_1_COPY2
	Int Storage	N7602B_1_COPY3
	BBG Memory	N7602B_1_COPY3

**Example: Finding the History of a Waveform 5-Pack License**

Use the following procedure to create a catalog of licensed Waveform 5-Pack files in the internal storage or USB media. Refer to [Figure 8-44 on page 248](#), for the following procedure.

The following procedure generates a catalog for a Waveform 5-Pack file labeled: N7602B-WFM1.

1. On the signal generator:
  - a. Press **Mode > Dual ARB > More > Waveform Utilities > 5-Pack Licensing > 5-Pack History**
  - b. Use the arrow keys to highlight the cataloged file N7602B-WFM1.
  - c. Press **Find Waveform**

The instrument displays a catalog titled “Waveform 5-Pack Search Results”. This catalog displays a list of all of the files that are copies of the original file that was licensed with the Waveform 5-Pack licensing, named N7602B-WFM1. For this example, the copies are currently in the BBG memory and the Internal storage and named N7602B-WFM1 and N7602B-WFM1\_COPY (respectively). Refer to [Figure 8-44 on page 248](#).

**NOTE** If no files are found, you can reload the backup copies that were made in [Step e on page 244](#).

**Figure 8-44 Using Waveform 5-Pack History “Find Waveform” Softkey**

Mode > Dual ARB > More >  
 Waveform Utilities > 5-Pack  
 Licensing > 5-Pack History

The highlighted file  
 N7602B-WFM1 is the  
 waveform created in this  
 example. (Notice the unique  
 Waveform ID displayed for  
 each licensed waveform.)

For details on each key,  
 use key help  
 as described on [page 42](#).

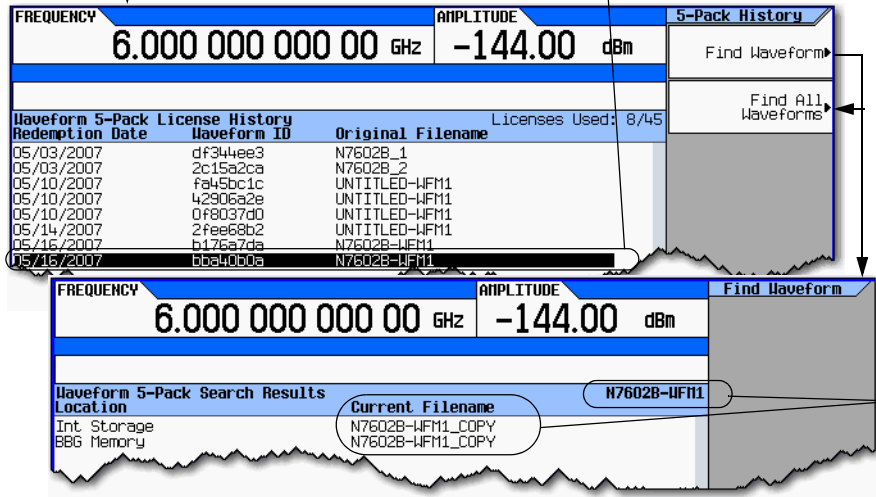

— see [page 249](#).

Notice that the originally 5-Pack licensed waveform, N7602B-WFM1, has been changed to N7602B-WFM1\_COPY and is saved in the Internal Storage and playing in the BBG Memory.  
 If no waveforms are listed when **Find Waveform** is pressed, then the waveform cannot be found in BBG Memory, Internal Storage, or USB Media.

### Finding All Waveforms Associated with 5-Pack Licenses

The following procedure displays a catalog of *all* of the Waveform 5-Pack files in the BBG memory and the internal storage:

1. On the signal generator:

- a. Press **Mode > Dual ARB > More > Waveform Utilities > 5-Pack Licensing > Find All Waveforms**

The instrument displays a catalog titled: Waveform 5-Pack Search Results. Refer to [Figure 8-45](#).

---

**NOTE** If no files are found, you can reload the backup copies that were made in [Step e](#) on [page 244](#).

---

**Figure 8-45 Using Waveform 5-Pack History “Find All Waveforms” Softkey**

**Mode > Dual ARB > More > Waveform Utilities >  
 5-Pack Licensing > 5-Pack History > Find All  
 Waveforms**

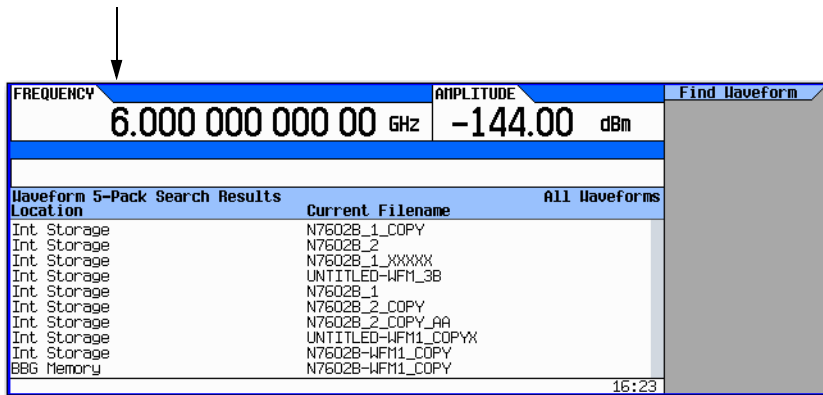

## Waveform 5-Pack Warning Messages

Figure 8-46

**Warning 1: Waveform Licensing Warning!!!**

Once a waveform is 5-Pack licensed it will use up an available license slot and it can not be un-licensed. Be sure that you want to license this waveform.

**Important! Keep a backup copy of the waveform elsewhere in case you delete all files in Int Storage.**

This standard warning is displayed every time a waveform is selected to be licensed. This notification indicates that one of the available "license slot[s]" is about to be used from Option 22x.

**ALWAYS make backup copies of waveforms in a separate non-volatile memory in case a file is deleted or lost from the instrument's**

---

**Warning 2: Waveform Backup Required!!!**

Waveform backup required. The waveform can not be licensed until it is copied to non-volatile memory.

**You must back up the waveform to non-volatile memory before you can license it.**

This warning is displayed when an attempt is made to license a waveform that has *not* been saved to internal storage or USB media (i.e. waveforms cannot be licensed unless they have been stored to non-volatile memory). Press the **Backup Waveform To Int Storage** softkey.

---

**Warning 3: Waveform Backup Failed!!!**

Waveform backup failed. The waveform could not be copied to non-volatile memory. There may not be enough free memory.

**You must free enough non-volatile memory to copy the waveform before you can license it.**

This warning is displayed when there is insufficient memory or other problems with the internal storage, or USB media (non-volatile memory) and the waveform could not be saved to non-volatile memory.

---

**Warning 4: Waveform Renaming Required!!!**

The file you are trying to license is not backed up in non-volatile memory, but a file in non-volatile memory has the same name.

**You must rename one of the files before adding the waveform to the 5-Pack license list.**

This warning is displayed when the file being licensed is *not* backed up in internal storage or the USB media (non-volatile memory), but there is a file *already* in the internal storage or USB media, with the same name.



---

## 9 Adding Real–Time Noise to a Signal (Option 403)

---

**NOTE** For the N5162A the softkey menus and features mentioned in this guide are only available through the Web–Enabled MXG or SCPI commands. For information on the Web–Enabled MXG, refer to the *Installation Guide*, the *Programming Guide*, and to the *SCPI Command Reference*.

---

Before using this information, you should be familiar with the basic operation of the signal generator. If you are not comfortable with functions such as setting the power level and frequency, refer to [Chapter 3, “Basic Operation,” on page 41](#) and familiarize yourself with the information in that chapter.

This feature is available only in N5162A/82A Agilent MXG Vector Signal Generators with Option 431. Option 431 requires Option 651, 652, or 654.

This chapter contains examples of using the additive white gaussian noise (AWGN) waveform generator, which is available only in vector signal generators with Option 403.

- [Adding Real–Time Noise to a Dual ARB Waveform](#) on page 251
- [Using Real Time I/Q Baseband AWGN](#) on page 257

### Adding Real–Time Noise to a Dual ARB Waveform

---

**NOTE** The procedures in this section that pertain specifically to adding Real–Time Noise (AWGN) to a waveform, are applicable to the Custom ARB, Multitone, and Two–Tone modulation standards too.

---

A vector signal generator with option 403 enables you to apply additive white gaussian noise (AWGN) to a carrier in real time while the modulating waveform plays in the dual ARB waveform player. This feature appears in each of the arb formats and as a stand–alone menu (Refer to [Figure 9-7 on page 257](#)).

Figure 9-1 Real Time I/Q Baseband AWGN Softkeys

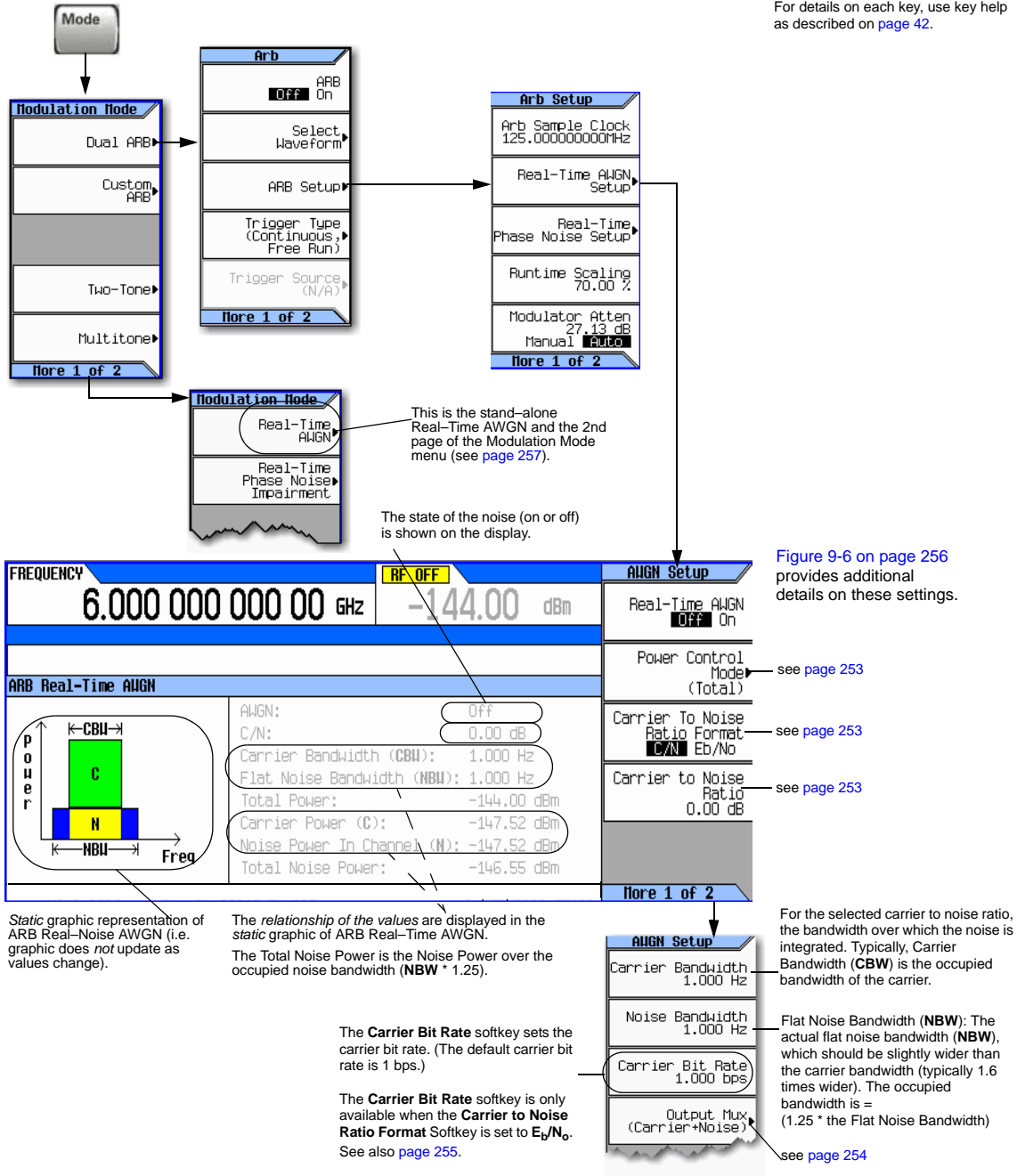

**Figure 9-2 Real Time I/Q Baseband AWGN - Power Control Mode Softkeys**  
 Mode > Dual ARB > Arb Setup >  
 Real-Time AWGN Setup

For details on each key, use key help as described on [page 42](#).

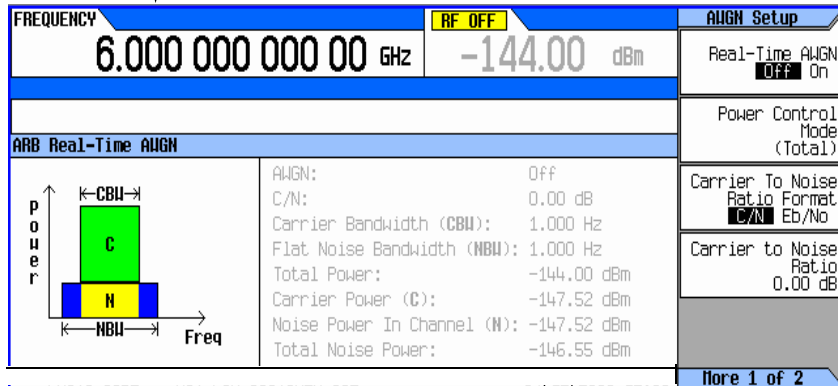
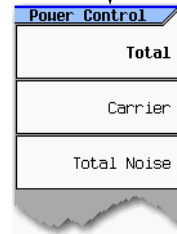

Figure 9-6 on page 256 provides additional details on these settings.

— see [page 254](#)

Selecting **Total** as the power control mode makes the total power and C/N independent variables while making the carrier power and total noise power dependent variables. The dependent variables carrier power and total noise power are set by the total power, C/N, and the rest of the Noise settings. The carrier power and total noise power change as any noise parameter is adjusted to keep the total power and the C/N at their last specified values.



Selecting **Carrier** as the power control mode makes the carrier power and C/N independent variables while making the total power and total noise power dependent variables. The dependent variables total power and total noise power are set by the carrier power, C/N, and the rest of the Noise settings. The total power and total noise power change as any noise parameter is adjusted to keep the carrier power and the C/N at their last specified values.

Selecting **Total Noise** as the power control mode makes the total noise power and C/N independent variables while making the total power and carrier power dependent variables. The dependent variables total power and carrier power are set by the total noise power, C/N, and the rest of the Noise settings. The total power and carrier power change as any noise parameter is adjusted to keep the total noise power and the C/N at their last specified values.

**Figure 9-3 Real Time I/Q Baseband AWGN - Noise Mux Menu Softkeys**

Mode > Dual ARB > Arb Setup >  
 Real-Time AWGN Setup > More

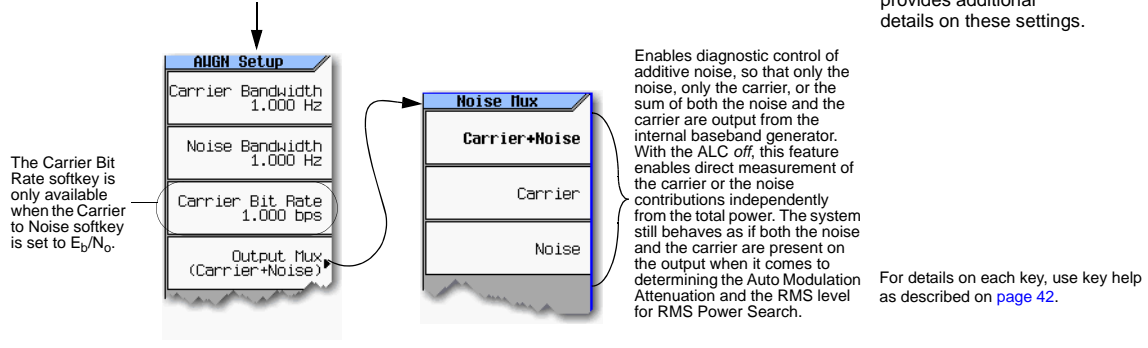

### $E_b/N_0$ Adjustment Softkeys for Real Time I/Q Baseband AWGN

This feature allows the AWGN C/N to be set using the  $E_b/N_0$  (energy per bit over noise power density at the receiver or signal to noise ratio per bit) form. This requires the carrier bit rate to be known. Refer to Figure 9-4, “ $E_b/N_0$  Carrier Bit Equation.”

**Figure 9-4  $E_b/N_0$  Carrier Bit Equation**

$$\frac{C}{N_{dB}} = \left(\frac{E_b}{N_0}\right) dB + 10 \log_{10} \left(\frac{bitRate}{carrierBandwidth}\right)$$

Figure 9-5 Real Time I/Q Baseband AWGN -  $E_b/N_0$  Adjustment Softkeys

Mode > Dual ARB > Arb Setup > Real-Time AWGN Setup

Display remains grayed out until real-time AWGN is enabled.

$E_b/N_0$  is displayed when Carrier to Noise Ratio Format softkey is set to  $E_b/N_0$ .

Eb/No(rate=1,000 bps): 0.00 dB

The Carrier Bit Rate softkey sets the carrier bit rate. (The default carrier bit rate is 1 bps.)

The Carrier Bit Rate softkey is only available when the Carrier to Noise Ratio Format Softkey is set to  $E_b/N_0$ .

To view the carrier bit rate equation, refer to page 42.

Figure 9-6 on page 256 provides additional details on these settings.

Selects either the Carrier to Noise Ratio (C/N) or energy per bit over noise power density at the receiver ( $E_b/N_0$ ) as the variable controlling the ratio of the carrier power to noise power in the carrier bandwidth. When  $E_b/N_0$  is selected, the second page of the AWGN Setup menu shows the Carrier Bit Rate softkey to enable the  $E_b/N_0$  value to be calculated.

The active softkey changes with the Carrier to Noise Ratio Format selected (C/N or  $E_b/N_0$ ). See below.

Whether a softkey is available depends on the Carrier to Noise Ratio Format softkey setting (e.g. C/N or  $E_b/N_0$ ).

C/N selected

Carrier to Noise Ratio 0.00 dB

Eb/No 0.00 dB

$E_b/N_0$  selected

For details on each key, use key help as described on page 42.

Figure 9-6 Carrier to Noise Ratio Components

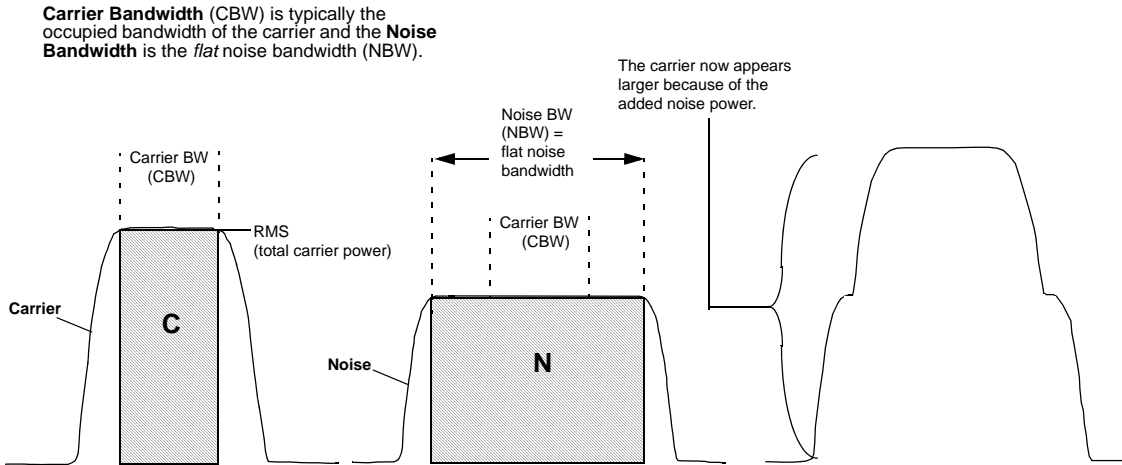

### Example

Use the following steps to modulate a 1 GHz, -10 dBm carrier with the factory-supplied waveform SINE\_TEST\_WFM, and then apply noise with a 45 MHz bandwidth signal that has a 30 dB carrier-to-noise ratio across a 40 MHz carrier bandwidth.

1. Preset the signal generator and set the following:
  - Frequency: 1 GHz
  - Amplitude: -10 dBm
  - RF output: on
2. Select the factory-supplied waveform SINE\_TEST\_WFM:
  - a. Press **Mode** > **Dual ARB** > **Select Waveform**.
  - b. Highlight SINE\_TEST\_WFM and press **Select Waveform**.
3. Turn on the dual ARB player: press **ARB Off On** to highlight On.
4. Set the ARB sample clock to 50 MHz: Press **ARB Setup** > **ARB Sample Clock** > **50** > **MHz**.
5. Press **Real-time Noise Setup** and set the following:
  - Carrier to Noise Ratio: 30 dB
  - Carrier Bandwidth: 40 MHz
  - Noise Bandwidth: 45 MHz
  - Real-time Noise: on

The signal generator's displayed power level (-10 dBm) *includes* the noise power.

## Using Real Time I/Q Baseband AWGN

Figure 9-7 Real Time I/Q Baseband AWGN Softkeys

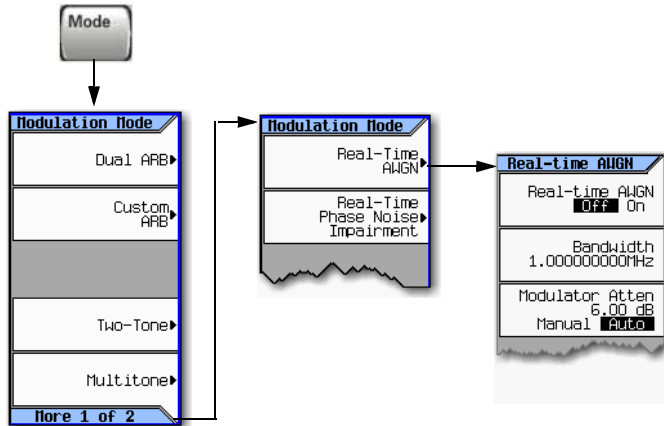

For details on each key, use key help as described on [page 42](#).

Use the following steps to apply 10 MHz bandwidth noise to a 500 MHz, -10 dBm carrier.

1. Configure the noise:
  - a. Preset the signal generator.
  - b. Press **Mode > More > Real Time I/Q Baseband AWGN**
  - c. Press **Bandwidth > 10 > MHz**.

2. Generate the noise:

Press **AWGN Off On** until **On** highlights.

During generation, the **AWGN** and **I/Q** annunciators activate (as shown at right). **AWGN** is now available to modulate the RF carrier.

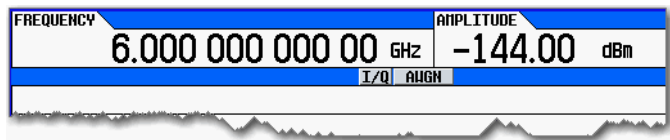

3. Configure the RF output:

- Frequency: 500 MHz
- Amplitude: -10 dBm
- RF output: on

The carrier with AWGN is now available at the signal generator's RF OUTPUT connector.





---

# 10 Real-Time Phase Noise Impairments (Option 432)

---

**NOTE** For the N5162A the softkey menus and features mentioned in this guide are only available through the Web-Enabled MXG or SCPI commands. For information on the Web-Enabled MXG, refer to the *Installation Guide*, the *Programming Guide*, and to the *SCPI Command Reference*.

---

Before using this information, you should be familiar with the basic operation of the signal generator. If you are not comfortable with functions such as setting the power level and frequency, refer to [Chapter 3, “Basic Operation,” on page 41](#) and familiarize yourself with the information in that chapter.

This feature is available only in N5162A/82A Agilent MXG Vector Signal Generators with Option 431. Option 431 requires Option 651, 652, or 654.

This chapter contains the softkey maps to locate the Phase Noise Impairment option functions and information on the use of this feature.

- [Real-Time Phase Noise Impairment](#) on page 260
- [The Agilent MXG Phase Noise Shape and Additive Phase Noise Impairments](#) on page 261
- [Understanding the Phase Noise Adjustments](#) on page 263
- [DAC Over-Range Conditions and Scaling](#) on page 264

## Real-Time Phase Noise Impairment

This feature lets you degrade the phase noise performance of the signal generator by controlling two frequency points and an amplitude value. The signal generator adds this phase noise to the phase noise normally produced by the Agilent MXG. This feature appears in each of the arb formats and as a stand-alone menu. While the following figure shows how to access the controls using both the stand-alone menu and the Dual ARB player, the location and softkeys within each arb format is the same as for the Dual ARB player.

Figure 10-1 Stand-Alone and Dual ARB Player Real-Time Phase Noise Softkeys

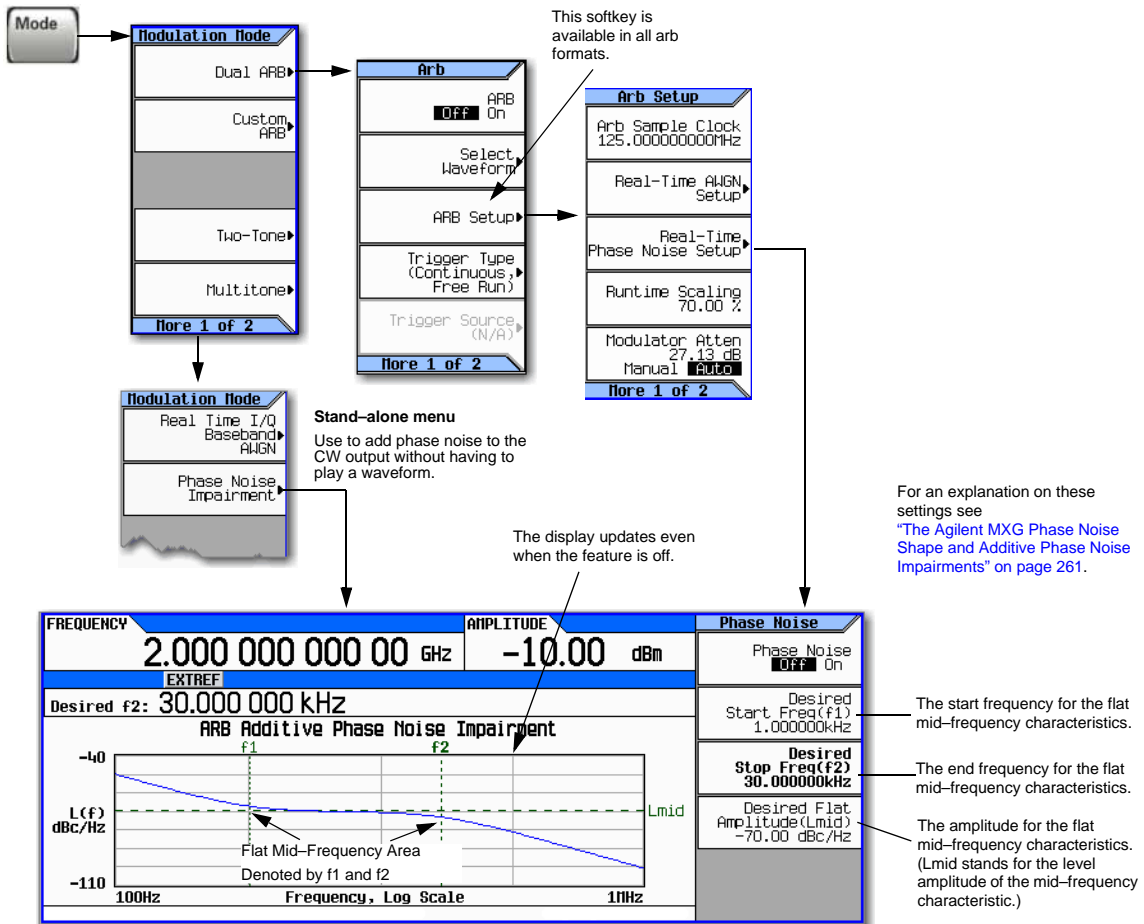

**NOTE:** The phase noise impairment is added to the base phase noise of the signal generator.

For details on each key, use key help as described on page 42.

## The Agilent MXG Phase Noise Shape and Additive Phase Noise Impairments

### Phase Noise Plots Without Phase Noise Impairment

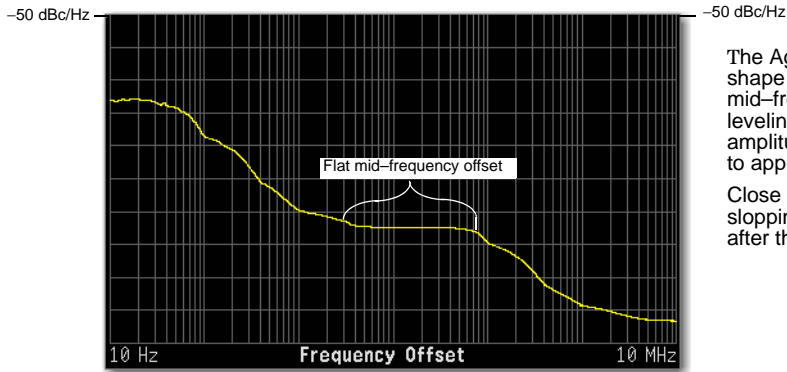

The Agilent MXG demonstrates a definitive shape to its phase noise plot. The mid-frequency offsets are characterized by a leveling (flattening) of the phase noise amplitude from approximately a 3 kHz offset to approximately a 70 kHz offset.

Close in and far out offsets demonstrate sloping characteristics (areas before and after the mid-frequency offsets).

The signal generator degrades the phase noise by moving the mid-frequency characteristics and/or changing its amplitude using the following settings:

- Start frequency ( $f_1$ ) of the mid-frequency characteristics
- Stop frequency ( $f_2$ ) of the mid-frequency characteristics
- Amplitude ( $L_{mid}$ ) of the mid-frequency characteristics

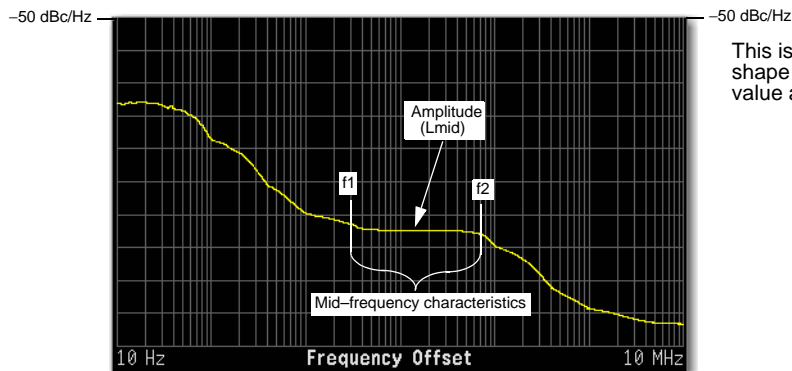

This is a plot of the unmodified phase noise shape that shows the location that each value alters.

**Phase Noise Plots With Phase Noise Impairments**

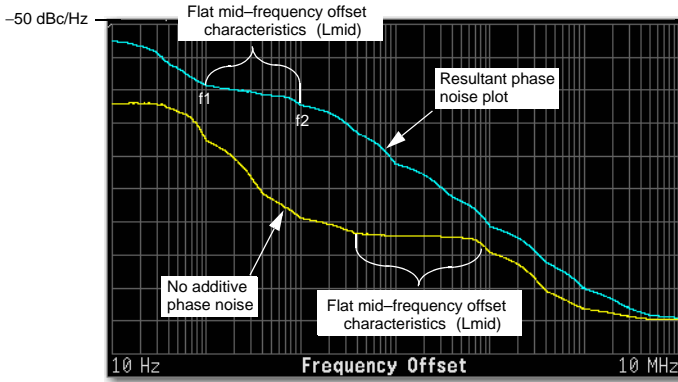

When turned on, this phase noise is added to the base phase noise of the signal generator.

Even though it is only the mid-frequency characteristics placement that are modified, these changes affect the entire phase noise shape. The close in and far out offset characteristics change by exhibiting approximately a 20 dBc/Hz slope for each octave of frequency offset.

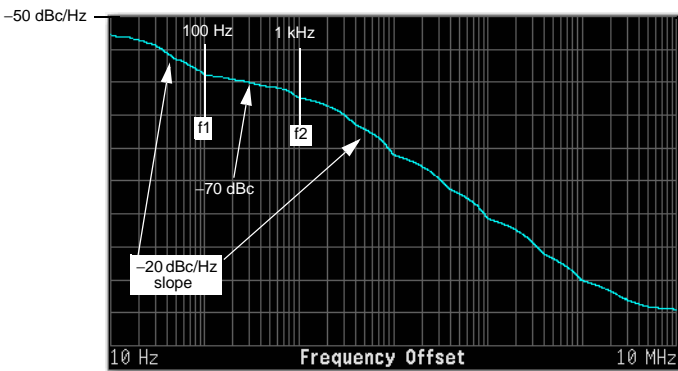

The resultant phase noise plot shown on the left has the following settings:

- $f_1 = 100 \text{ Hz}$
- $f_2 = 1 \text{ kHz}$
- Amplitude ( $L_{mid}$ ) =  $-70 \text{ dBc}$

Ensure that the  $f_1$  value is less than or equal to  $f_2$ . If not,  $f_2$  changes its value to match  $f_1$ . Conversely if  $f_2$  is set to a value that is less than  $f_1$ ,  $f_1$  changes its value to match  $f_2$ .

The frequency values entered for the impairments may not be the exact values when viewed on the RF output. The entered values are guidelines that the signal generator uses to calculate the real values. See [“Understanding the Phase Noise Adjustments” on page 263](#) for more information.

To view the results of the settings ( $f_1$ ,  $f_2$ , and  $L_{mid}$ ), use the front panel graph (below and on [page 260](#)) or view the phase noise plot on a measurement instrument (shown above—Agilent E4440A PSA with Option 226).

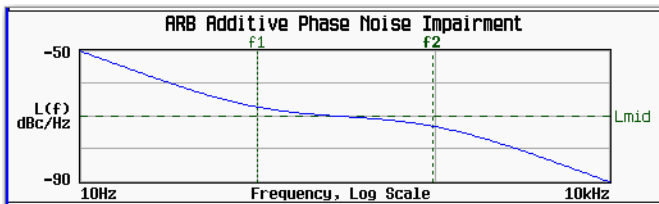

Signal generator front panel plot:

- $f_1 = 100 \text{ Hz}$
- $f_2 = 1 \text{ kHz}$
- $L_{mid} = -70 \text{ dBc}$

## Understanding the Phase Noise Adjustments

The signal generator bases the resultant phase noise shape on three settings, Lmid (amplitude), f1 (start frequency), and f2 (stop frequency).

The range for Lmid is coupled to f2, so as f2 increases in value, Lmid's upper boundary decreases. If the current Lmid setting is too high for the new f2 setting, the signal generator changes the Lmid value and generates an error to alert you to the change. In addition, the actual Lmid value can vary by 0.28 dBc/Hz from the entered value.

The frequency settings (f1 and f2) are really guidelines that the signal generator uses to calculate the real frequency offset values seen on the RF OUTPUT. This means that the entered start and stop frequency values are an approximation and may not be the values seen on a measurement instrument, however they will be close.

The effects of the f1 and f2 parameters are based on a varying logarithmic scale. This scale is determined by the f2 value. The higher the f2 value the larger the scale, which makes this behavior more noticeable at higher frequency settings. This becomes apparent when a change in the f1 or f2 value causes little to no change in the f1 or f2 position. This is easy to view using the signal generator's front panel phase noise graph and demonstrated in Figure 10-2. This behavior makes the frequency adjustments coarser as the f2 frequency value increases.

Figure 10-2 f1 and f2 Frequency Setting Behavior

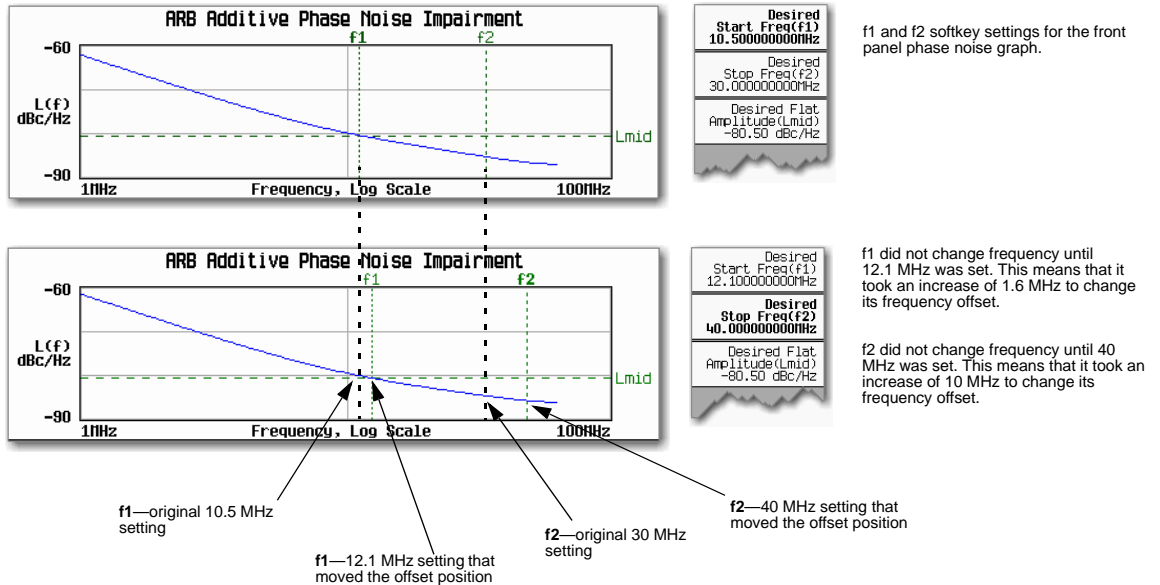

For details on each key, use key help as described on page 42.

The only way to make an accurate determination of the effect of the f1 and f2 values is by viewing the front panel graph or making a measurement. You can view the front panel graph remotely by using the LXI interface. For more information on the LXI interface, see the *Programming Guide*.

## DAC Over-Range Conditions and Scaling

When using phase noise impairment, it is possible to create a DAC over-range condition, which causes the Agilent MXG to generate an error. To minimize this condition with the phase noise impairment feature, the Agilent MXG incorporates an automatic DAC over-range protection feature that scales down the I/Q data. Because it can scale the data by more than what is actually need, it typically decreases the dynamic range of the waveform. This is especially noticeable when using a constant amplitude signal such as GSM.

For the Dual ARB Player, the automatic over-range protection can be turned off (on is the factory default). The control for the Dual ARB DAC over-range protection feature is located in the key path as shown in [Figure 10-3](#).

**Figure 10-3 Dual ARB DAC Over-Range Protection Softkey Location**

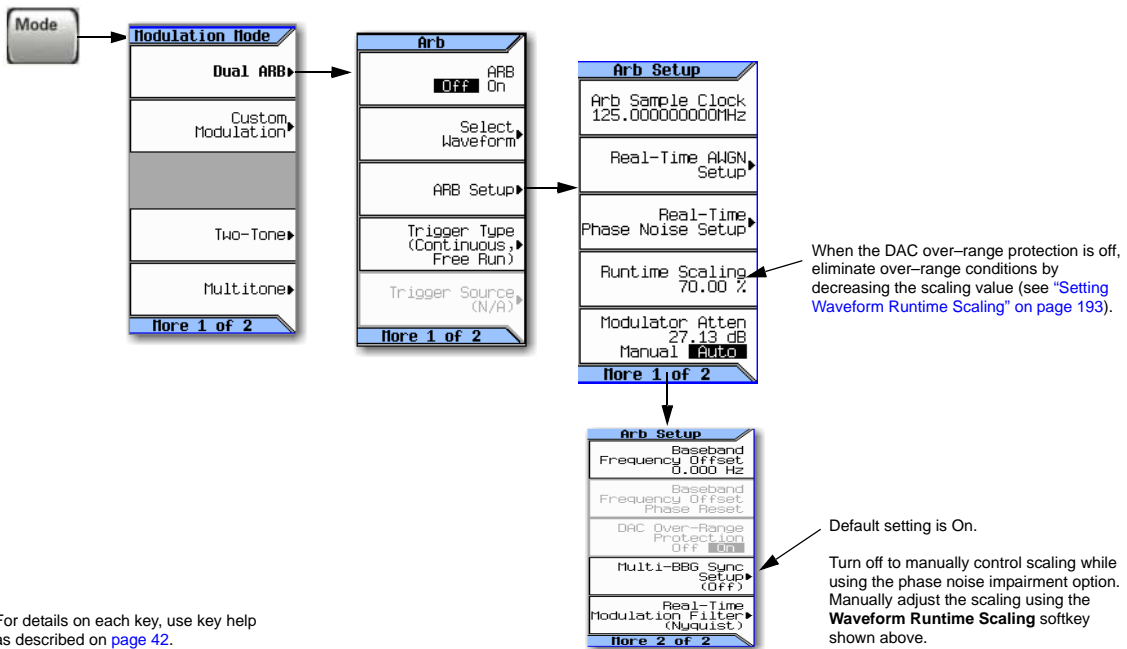

In the Dual ARB Player, to avoid excessive scaling or to just perform scaling manually, turn the over-range protection off and use the **Waveform Runtime Scaling** softkey to eliminate DAC over-range conditions.

When the automatic feature is disabled, the other options to eliminate a DAC over-range condition are to reduce the f2 value, or the Lmid value, or both until the condition corrects itself.

---

# 11 Custom Digital Modulation (Option 431)

---

**NOTE** For the N5162A, the softkey menus and features mentioned in this guide are only available through the Web-Enabled MXG or SCPI commands. For information on the Web-Enabled MXG, refer to the *Installation Guide*, the *Programming Guide*, and to the *SCPI Command Reference*.

---

Before using this information, you should be familiar with the basic operation of the signal generator. If you are not comfortable with functions such as setting the power level and frequency, refer to [Chapter 3, “Basic Operation,” on page 41](#) and familiarize yourself with the information in that chapter.

This feature is available only in N5162A/82A Agilent MXG Vector Signal Generators with Option 431. Option 431 requires Option 651, 652, or 654.

- [Custom Modulation](#) on page 266
- [Using the Arbitrary Waveform Generator](#) on page 271
- [Using Finite Impulse Response \(FIR\) Filters in ARB Custom Modulation](#) on page 281
- [Modifying a FIR Filter Using the FIR Table Editor](#) on page 286
- [Differential Encoding](#) on page 289

## Custom Modulation

Custom Modulation has built-in modulation standards such as TETRA and DECT; and pre-defined modulation types such as BPSK and 16QAM that can be used to create a signal in addition, it provides the flexibility to modify the digital format's attributes.

### ARB Custom Modulation Waveform Generator

The signal generator's ARB Waveform Generator mode is designed for out-of-channel test applications. This mode can be used to generate data formats that simulate random communication traffic and can be used as a stimulus for component testing. Other capabilities of the ARB Waveform Generator mode include:

- configuring single or multicarrier signals. Up to 100 carriers can be configured.
- creating waveform files using the signal generator's front panel interface.

The waveform files, when created as random data, can be used as a stimulus for component testing where device performance such as adjacent channel power (ACP) can be measured. The AUTOGEN\_WAVEFORM file, that is automatically created when you turn the ARB Waveform Generator on, can be renamed and stored in the signal generator's non-volatile memory. This file can later be loaded into volatile memory and played using the dual ARB waveform player.

For more information, refer to [“Waveform File Basics” on page 142](#) and [“Modes of Operation” on page 4](#).



**Figure 11-1 ARB Custom Modulation Softkeys**

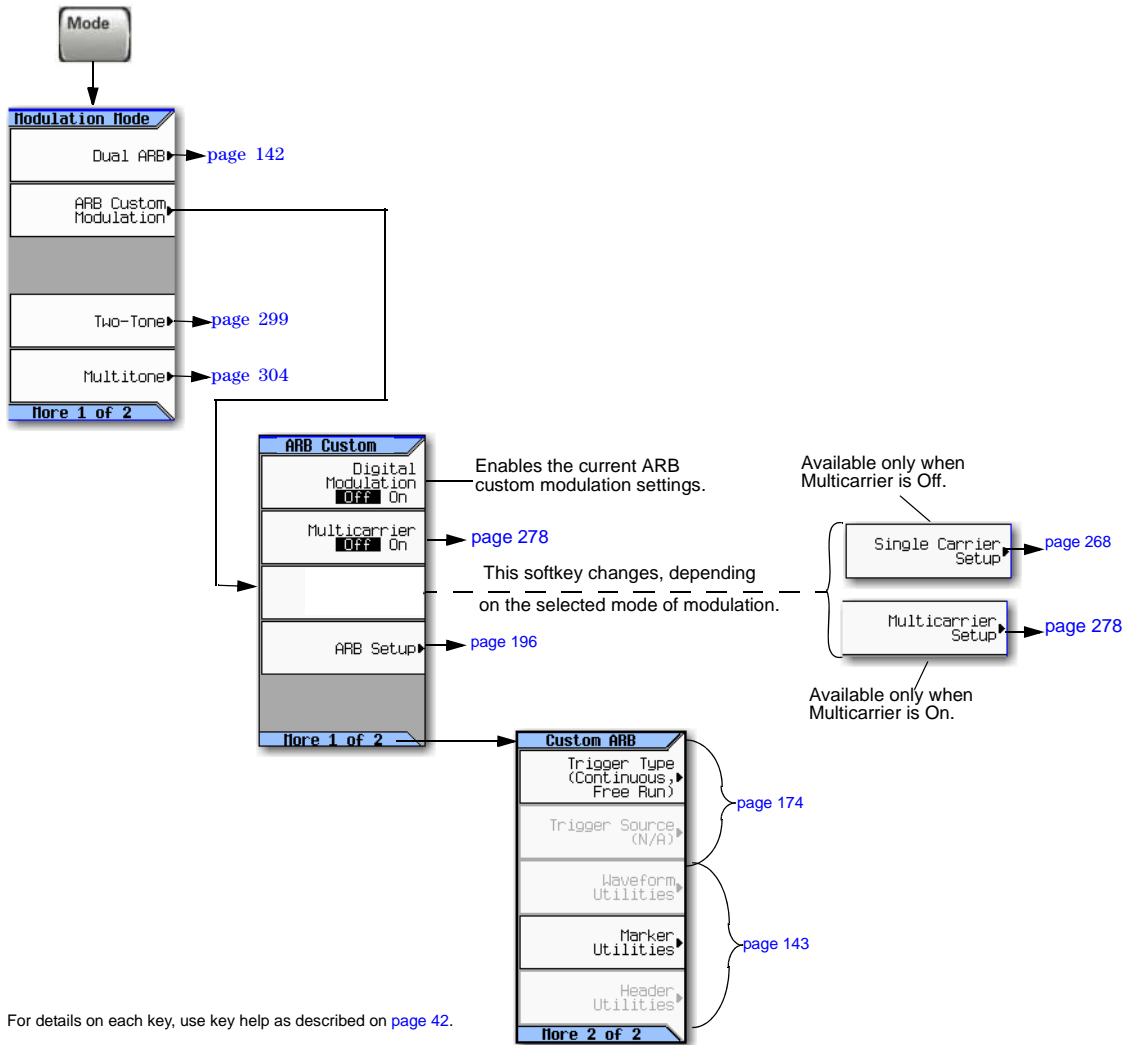

Figure 11-2 Quick Setup Softkeys

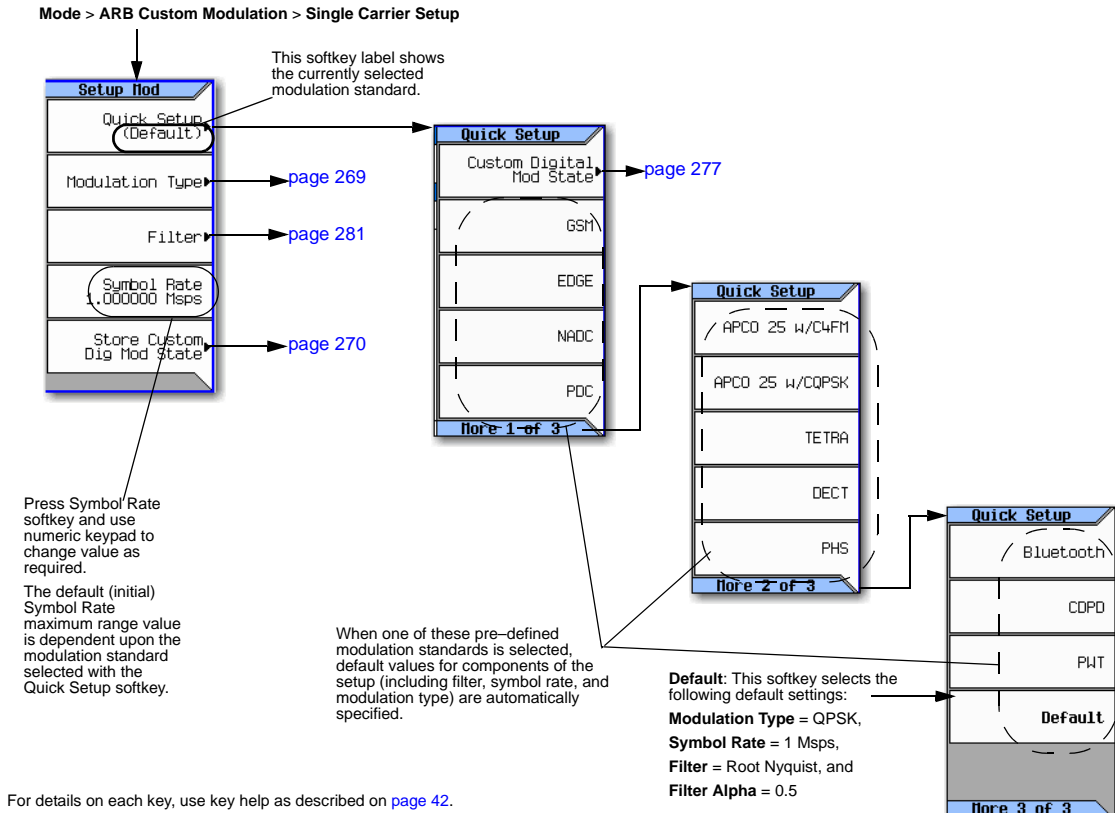
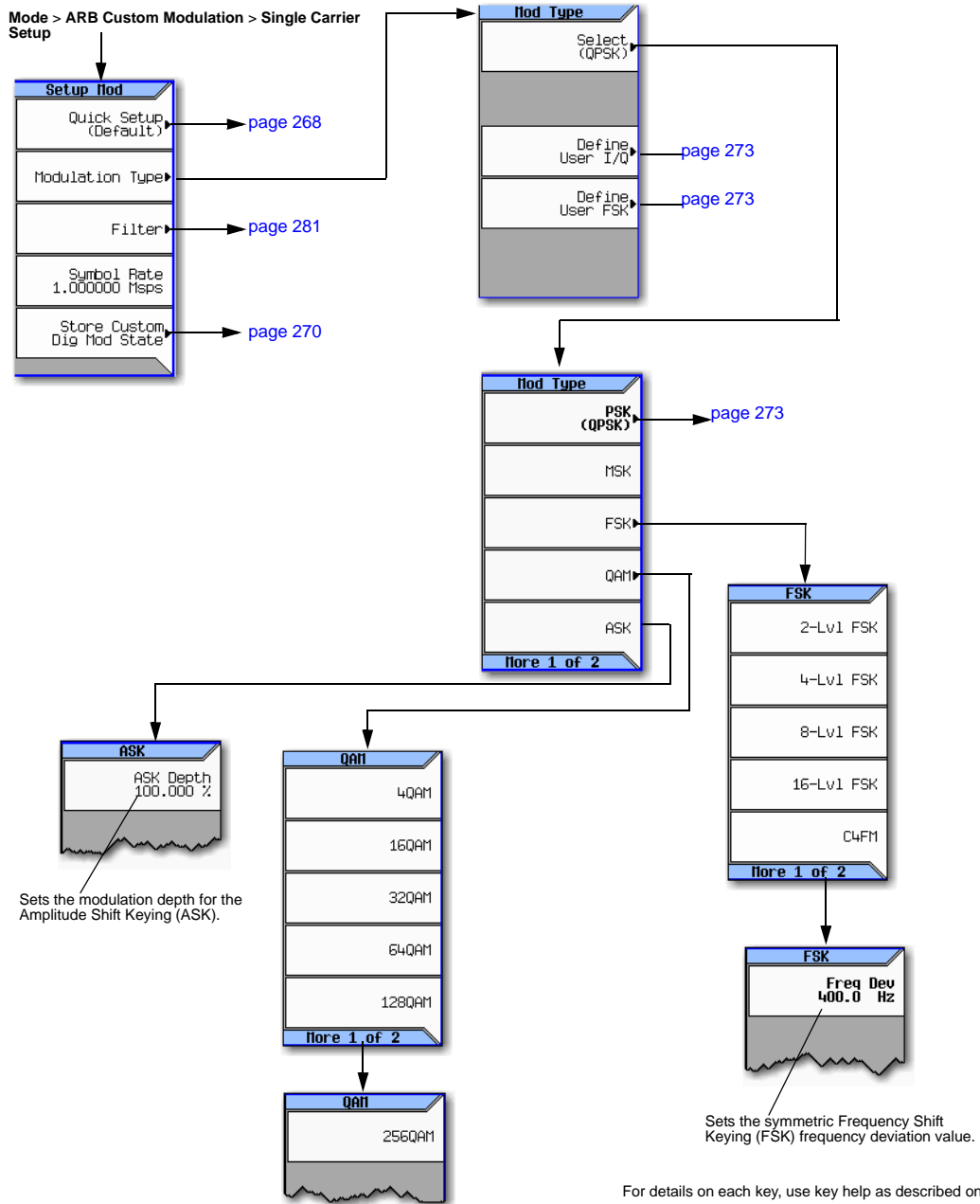

Figure 11-3 Mode Type Softkeys



**Figure 11-4 Store Custom Dig Mod State Softkeys**

Mode > ARB Custom Modulation > Single Carrier Setup > Store Custom Dig Mod State

The screenshot shows the 'Store State' menu with the following options: 'Store To File', 'Delete File', and 'Goto Row'. Callouts point to 'Confirm Delete' and 'Goto Row' softkey menus. A note indicates that the 'Catalog of DMOD Files in Int Storage' displays digital modulation (DMOD) files.

File Name	Type	Size	Modified
1 FIR_EXAM	DMOD	312	01/24/07 14:22

01/24/2007 16:56

Catalog displays digital modulation (DMOD) files that have been previously saved.

For details on each key, use key help as described on [page 42](#).

## Using the Arbitrary Waveform Generator

This section teaches you how to build dual arbitrary (ARB) waveform files containing custom TDMA, digital modulation for testing component designs.

**Figure 11-5 Adding Custom Modulation to a Waveform**

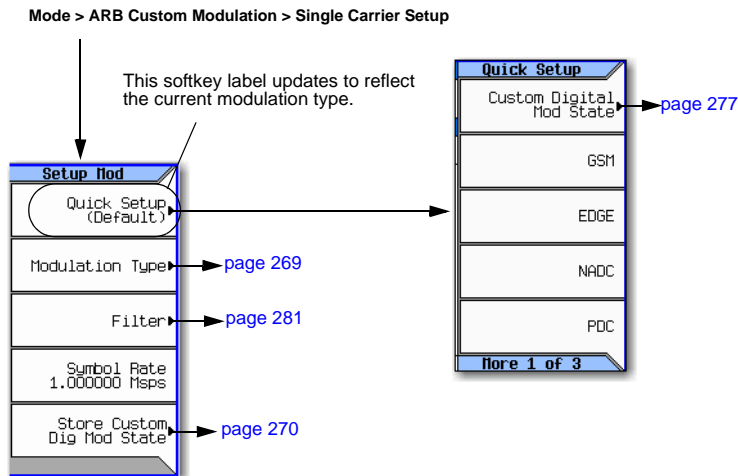

For details on each key, use key help as described on [page 42](#).

## Using Predefined Custom TDMA Digital Modulation

This section teaches you how to perform the following tasks:

- [Selecting a Predefined EDGE Setup](#) on page 271
- [Generating the Waveform](#) on page 271
- [Configuring the RF Output](#) on page 272

### Selecting a Predefined EDGE Setup

1. Press **Preset**.
2. In the ARB Custom Modulation menu ([page 271](#)), press **Single Carrier Setup** > **Quick Setup** > **EDGE**.

### Generating the Waveform

Press **Digital Modulation Off On**.

This generates a waveform with the pre-defined EDGE state selected in the step. The display changes to Dig Mod Setup: EDGE. During waveform generation, the DIGMOD and I/Q annunciators appear and the pre-defined digital modulation state is stored in volatile memory (BBG). The waveform is now modulating the RF carrier.

### **Configuring the RF Output**

1. Set the RF output frequency to 891 MHz.
2. Set the output amplitude to -5 dBm.
3. Press **RF On/Off**.

The predefined EDGE signal is now available at the signal generator's RF OUTPUT connector.

## Creating a Custom TDMA Digital Modulation State

In this procedure, you learn how to set up a single-carrier NADC digital modulation with customized modulation type, symbol rate, and filtering.

**Figure 11-6 Setting a Digital Modulation Filter**

Mode > ARB Custom Modulation > Single Carrier Setup

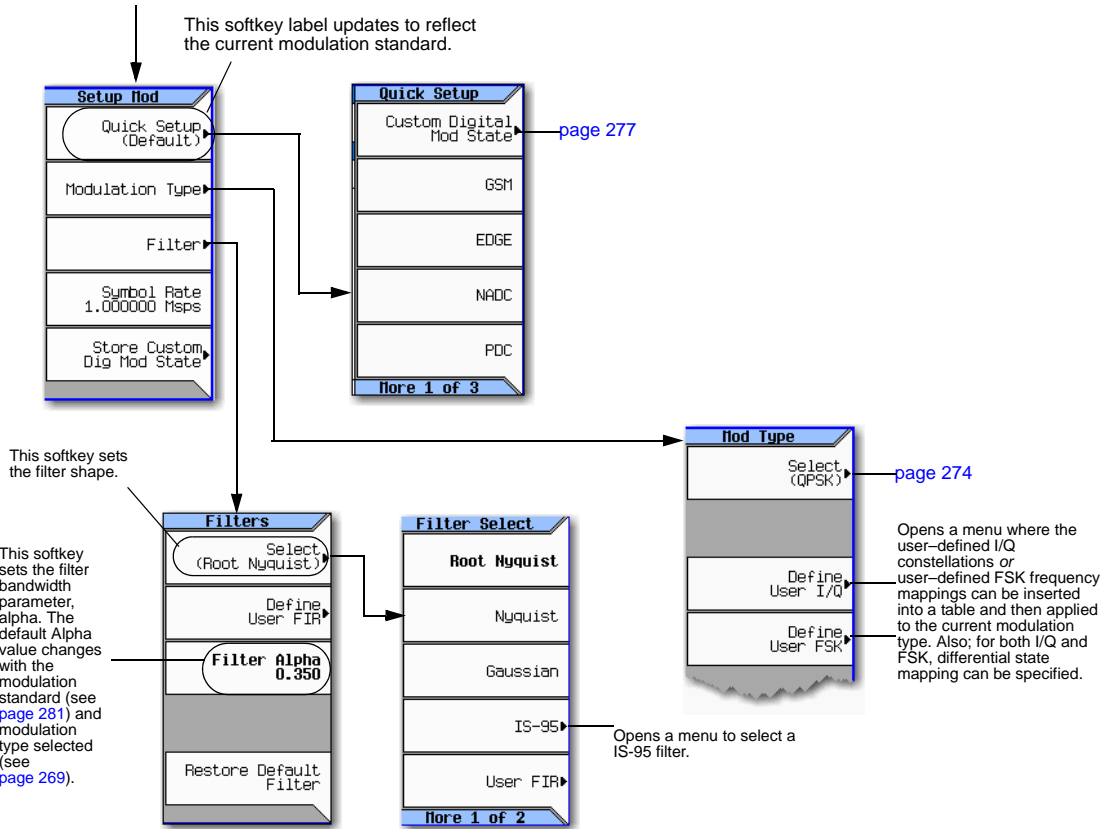

For details on each key, use key help as described on [page 42](#).

**Figure 11-7 Modifying a Digital Modulation Type**

Mode > ARB Custom Modulation > Single Carrier Setup > Modulation Type > Select

For details on each key, use key help as described on [page 42](#).

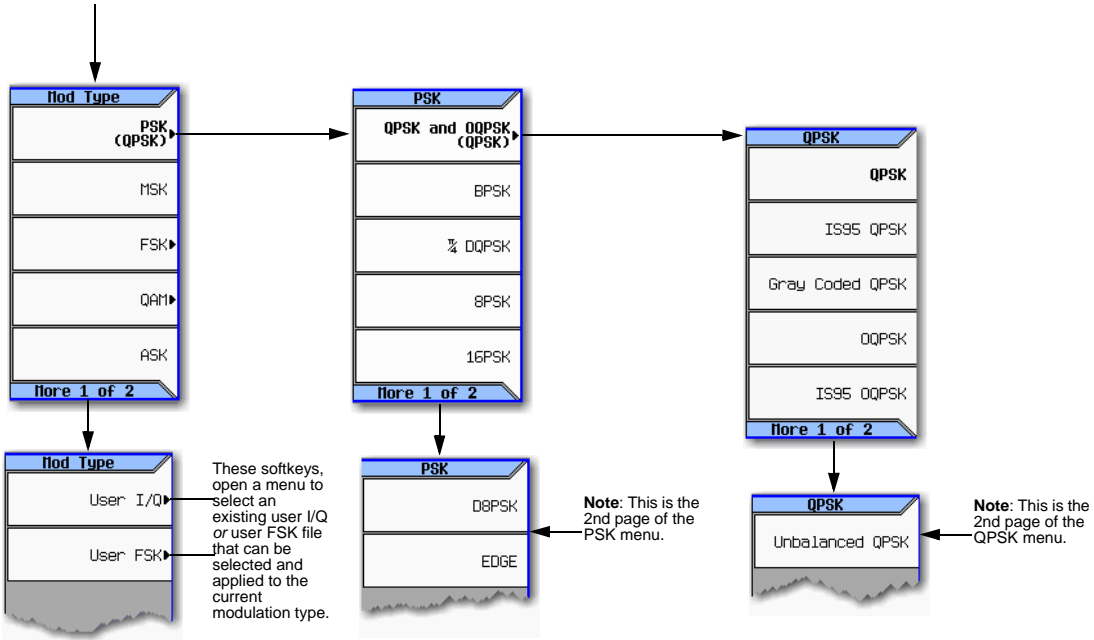

This section teaches you how to perform the following tasks:

- [Selecting a Digital Modulation Setup](#) on page 274
- [Configuring the RF Output](#) on page 272
- [Selecting the Filter](#) on page 275
- [Configuring the RF Output](#) on page 272

### Selecting a Digital Modulation Setup

1. Press **Preset**.
2. In the ARB Custom Modulation menu ([page 273](#)), press **Single Carrier Setup > Quick Setup > NADC**.

### Modifying the Modulation Type and Symbol Rate

1. In the ARB Custom Modulation menu ([page 273](#)), press **Single Carrier Setup > Modulation Type > Select > PSK > QPSK and OQPSK > QPSK**.
2. Press **Return > Symbol Rate > 56 > kbps**.



### Selecting the Filter

1. In the Setup Mod menu ([page 273](#)), press **Filter > Select > Nyquist**.
2. Press **Return > Return**.

### Generating the Waveform

Press **Digital Modulation Off On**.

This generates a waveform with the custom, single-carrier NADC, digital modulation state created in the previous sections. The display changes to Dig Mod Setup: NADC (Modified). During waveform generation, the DIGMOD and I/Q annunciators appear and the custom single-carrier digital modulation state is stored in volatile memory. The waveform is now modulating the RF carrier.

For instructions on storing this custom, single-carrier NADC, digital modulation state to the non-volatile memory catalog, see [Storing a Custom TDMA Digital Modulation State](#) on page 275.

### Configuring the RF Output

1. Set the RF output frequency to 835 MHz.
2. Set the output amplitude to 0 dBm.
3. Press **RF On/Off**.

The user-defined NADC signal is now available at the RF OUTPUT connector.

### Storing a Custom TDMA Digital Modulation State

Using this procedure, you learn how to store a custom digital modulation state and a custom multicarrier digital modulation state to non-volatile memory.

If you have not created a custom, single-carrier, digital modulation state, complete the steps in the previous section, [Creating a Custom TDMA Digital Modulation State](#) on page 273.

Figure 11-8 Storing a Custom Digital Modulation State

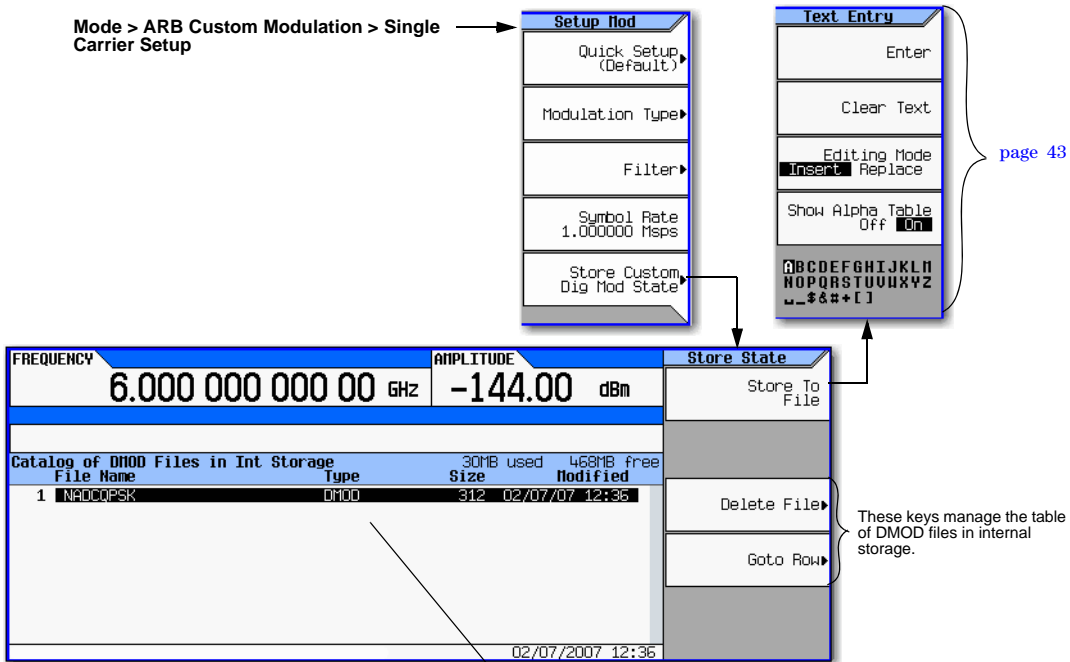

Catalog displays DMOD files that have been previously saved by the user.

For details on each key, use key help as described on page 42.

1. Return to the top-level ARB Custom Modulation menu, where **Digital Modulation Off On** is the first softkey.
2. In the ARB Custom Modulation menu (page 276), press **Single Carrier Setup > Store Custom Dig Mod State > Store To File**.

If there is already a file name from the Catalog of DMOD Files occupying the active entry area, press the following key: **Clear Text**

3. Enter a file name (for example, NADCQPSK) using the alpha keys and the numeric keypad with a maximum length of 23 characters.
4. Press **Enter**.

The user-defined, single-carrier, digital modulation state is now stored in non-volatile memory.

**NOTE** The RF output amplitude, frequency, and operating state settings are not stored as part of a user-defined, digital modulation state file.

## Recalling a Custom TDMA Digital Modulation State

Using this procedure, you will learn how to recall a custom digital modulation state from signal non-volatile memory.

If you have not created and stored a user-defined, single-carrier, digital modulation state, complete the steps in the previous sections, [Creating a Custom TDMA Digital Modulation State](#) on page 273 and [Storing a Custom TDMA Digital Modulation State](#) on page 275, then preset the signal generator to clear the stored user-defined, digital modulation waveform from volatile ARB memory.

**Figure 11-9 Recalling a Custom TDMA Digital Modulation State**

Mode > ARB Custom Modulation > Single Carrier Setup >

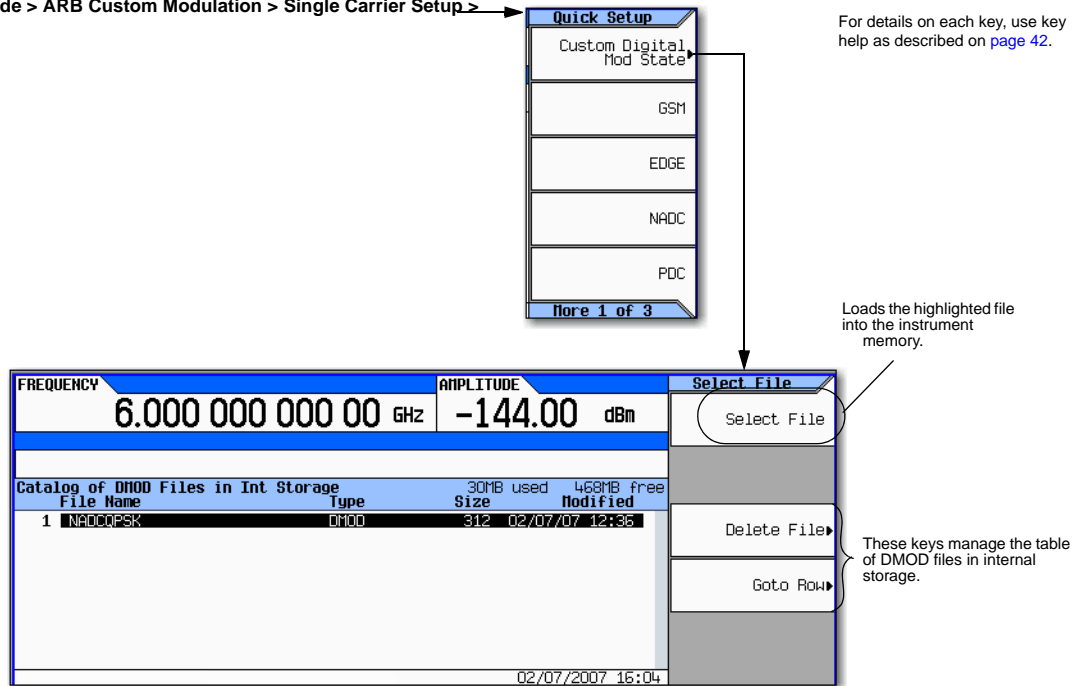

1. In the Quick Setup menu, press **Custom Digital Mod State**.
2. Highlight the desired file (for example, NADCQPSK).
3. Press **Select File > Return**.
4. Press **Digital Modulation Off On** until On is highlighted.

The instrument regenerates the custom, digital modulation waveform in volatile memory. After waveform generation, the custom, digital modulation waveform is available to be modulated on the RF output.

For instruction on configuring the RF output, see [Configuring the RF Output](#) on page 272.

## Creating a Custom Multicarrier TDMA Digital Modulation State

In this procedure, you learn how to customize a predefined, multicarrier, digital modulation setup by creating a custom, 3-carrier EDGE, digital modulation state.

This section teaches you how to perform the following tasks:

- [Creating a Multicarrier Digital Modulation Setup](#) on page 279
- [Modifying Carrier Frequency Offset](#) on page 279
- [Modifying Carrier Power](#) on page 279
- [Generating the Waveform](#) on page 279
- [Configuring the RF Output](#) on page 279

Figure 11-10 Creating a Multicarrier Digital Modulation Setup

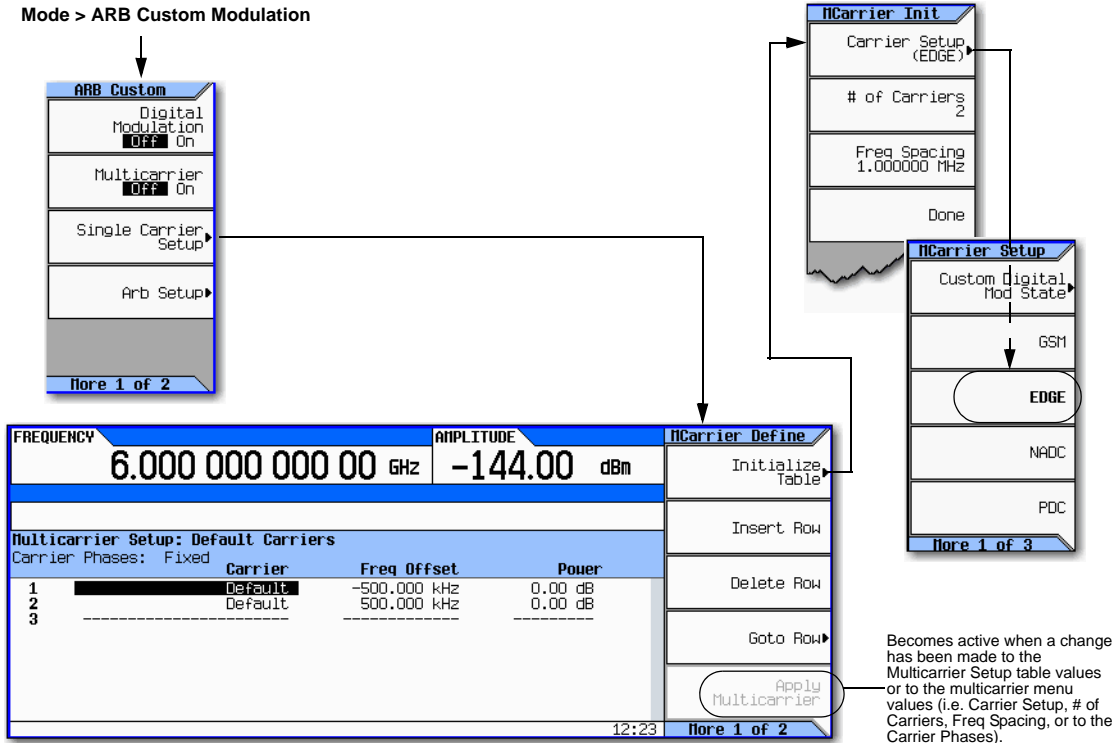

For details on each key, use key help as described on [page 42](#).

### Creating a Multicarrier Digital Modulation Setup

1. Press **Preset**.
2. Press **Mode > ARB Custom Modulation > Multicarrier Off On** to **On**.
3. Press **Multicarrier Setup > Select Carrier and Initialize Table > Carrier Setup > EDGE > Done**.

### Modifying Carrier Frequency Offset

1. Highlight the Freq Offset value (500.000 kHz) for the carrier in row 2.
2. Press **-625 > kHz**.

### Modifying Carrier Power

1. Highlight the Power value (0.00 dB) for the carrier in row 2.
2. Press **-10 > dB**.

You now have a custom 2-carrier EDGE waveform with a carrier at a frequency offset of -625 kHz and a power level of -10.00 dBm, as shown in the following figure.

FREQUENCY	AMPLITUDE	MC Carrier Define
6.000 000 000 00 GHz	-144.00 dBm	Initialize Table
Multicarrier Setup: EDGE Carriers (Modified)		
Carrier Phases: Fixed		
	Carrier	Freq Offset
1	EDGE	-500.000 kHz
2	EDGE	-625.000 kHz
3	-----	-----
	Power	
		0.00 dB
		-10.00 dB
		-----
02/21/2007 16:09		
Page 1 of 2		

For details on each key, use key help as described on page 42.

If Digital Modulation is already on, you must press Apply Multicarrier to apply the changes and generate a new custom multicarrier digital modulation waveform based on the updated values.

### Generating the Waveform

Press **Return > Digital Modulation Off On**.

This generates a waveform with the custom, multicarrier, EDGE state created in the previous sections. The display changes to Dig Mod Setup: Multicarrier (Modified). During waveform generation, the DIGMOD and I/Q annunciators appear and the new custom, multicarrier, EDGE state is stored in volatile memory. The waveform is now modulating the RF carrier.

For instructions on storing this custom, multicarrier, EDGE state to non-volatile memory, see “Storing a Custom Multicarrier TDMA Digital Modulation State” on page 280.

### Configuring the RF Output

1. Set the RF output frequency to 890.01 MHz.
2. Set the output amplitude to -10 dBm.
3. Press **RF On/Off**.

The custom multicarrier EDGE signal is now available at the RF OUTPUT connector.

## Storing a Custom Multicarrier TDMA Digital Modulation State

Using this procedure, you learn how to store a custom, multicarrier, TDMA, digital modulation state to non-volatile memory.

If you have not created a custom, multicarrier, digital modulation state, complete the steps in the previous section, “Creating a Custom Multicarrier TDMA Digital Modulation State” on page 278.

Figure 11-11 Storing a Custom Multicarrier Softkeys

Carrier	Carrier	Freq Offset	Power
1	EDGE	-500.000 kHz	0.00 dB
2	EDGE	-625.000 kHz	-10.00 dB
3	-----	-----	-----

Carrier Phases: Fixed Random

Load/Store

Edit Item

02/21/2007 17:22 Page 2 of 2

Fixed: All the carriers are set to a phase of 0.  
Random: All of the carriers are set to a random phase value.

page 43

For details on each key, use key help as described on page 42.

1. Return to the top-level Digital Modulation menu, where **Digital Modulation Off On** is the first softkey.
2. Press **Multicarrier Setup > More > Load/ Store > Store To File**.  
If there is already a file name from the Catalog of MDMOD Files occupying the active entry area, press the following key: **Clear Text**
3. Enter a file name (for example, EDGEM1) using the alpha keys and the numeric keypad with a maximum length of 23 characters.
4. Press **Enter**.

The user-defined, multicarrier, digital modulation state is now stored in non-volatile memory.

---

**NOTE** The RF output amplitude, frequency, and operating state settings are not stored as part of a user-defined, digital modulation state file.

---

## Applying Changes to an Active Multicarrier TDMA Digital Modulation State

If the digital modulation format is currently in use (**Digital Modulation Off On** set to On) while changes are made in the Multicarrier Setup table editor, you must apply the changes before the updated waveform will be generated.

From the Multicarrier Setup table editor, press **Apply Multicarrier** to apply the changes and generate a new custom multicarrier digital modulation waveform based on the updated values.

## Using Finite Impulse Response (FIR) Filters in ARB Custom Modulation

Finite Impulse Response filters can be used to refine the transitions between symbol decision points of the generated waveforms.

**Figure 11-12 Filter Menu**

Mode > ARB Custom Modulation > Single Carrier Setup > Filter

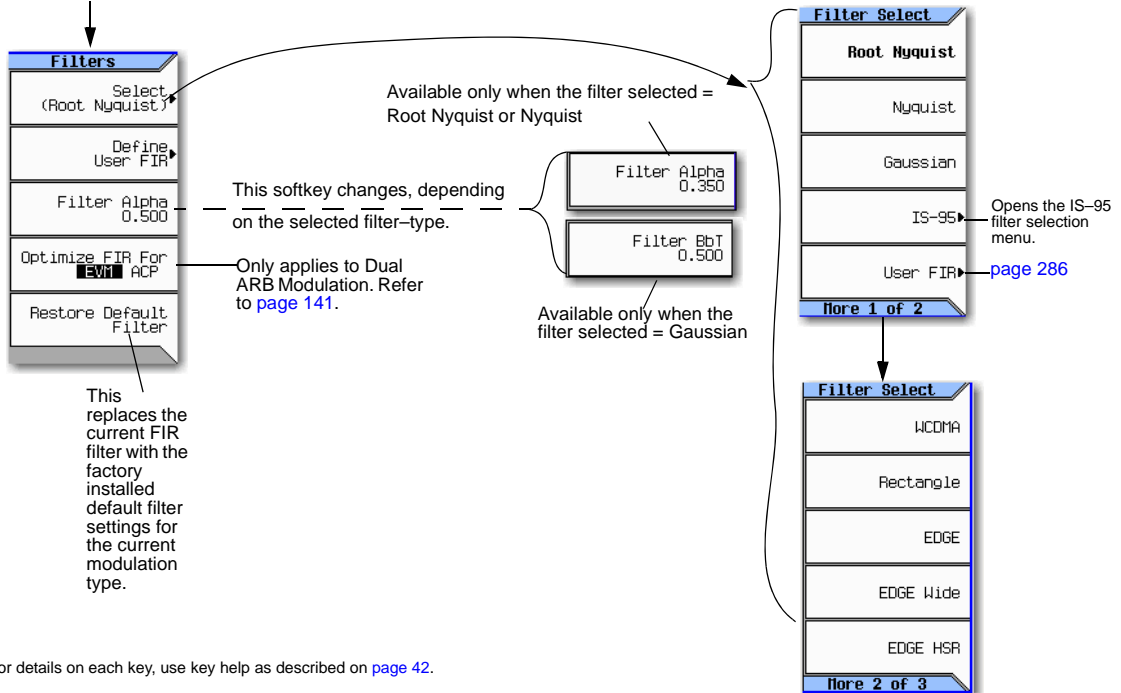

### Creating a User-Defined FIR Filter Using the FIR Table Editor

In this procedure, you use the FIR Values table editor to create and store an 8-symbol, windowed sync function filter with an oversample ratio of 4.

#### Accessing the Table Editor

1. Press **Presets**.
2. Press **Mode > ARB Custom Modulation > Single Carrier Setup > Select > Nyquist**.
3. Press **Filter > Define User FIR**.
4. Press **More 1 of 2 > Delete All Rows > Confirm Delete of All Rows**.

This will initialize the table editor as shown in Figure 11-13.

**Figure 11-13** Creating a User-Defined FIR Filter Using the FIR Filter Table Editor

Mode > ARB Custom Modulation > Single Carrier Setup > Filter > Define  
User FIR > More 1 of 2 > Delete All Rows > Confirm Delete of All Rows

For details on each key, use key help as described on [page 42](#).

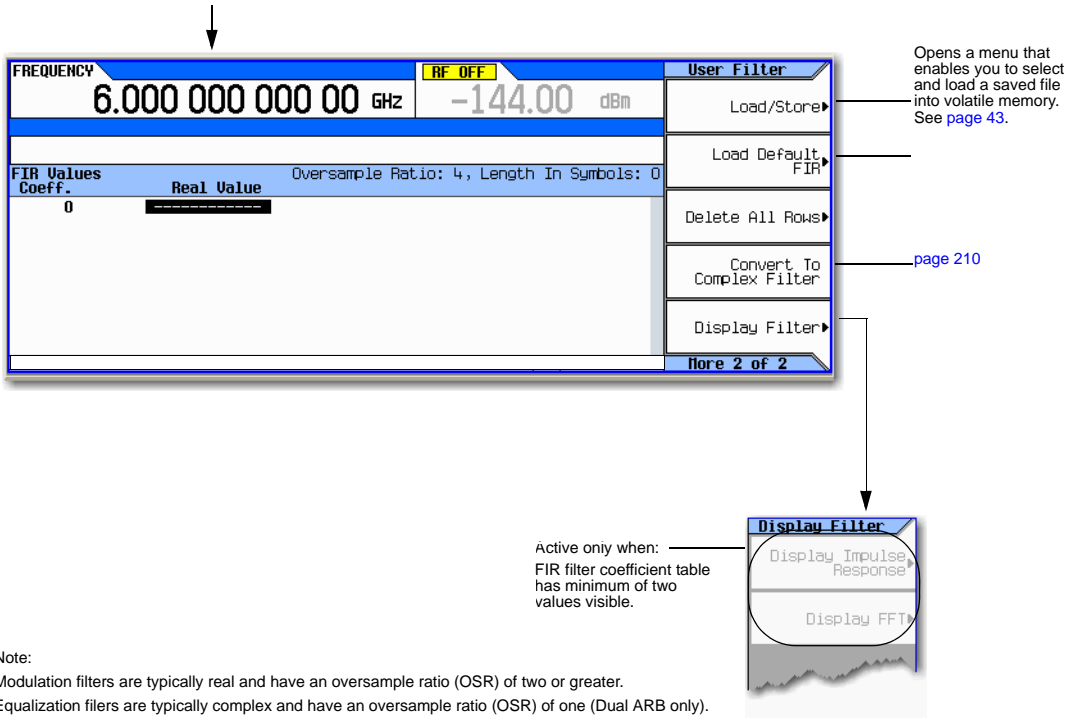

Note:  
Modulation filters are typically real and have an oversample ratio (OSR) of two or greater.  
Equalization filters are typically complex and have an oversample ratio (OSR) of one (Dual ARB only).

**Entering the Coefficient Values**

1. Press the **Return** softkey to get to the first page of the table editor.
2. Use the cursor to highlight the Value field for coefficient 0.
3. Use the numeric keypad to type the first value (-0.000076) from [Table 11-1](#). As you press the numeric keys, the numbers are displayed in the active entry area. (If you make a mistake, you can correct it using the backspace key.)
4. Continue entering the coefficient values from the table in step 1 until all 16 values have been entered.

**Table 11-1**

Coefficient	Value
0	-0.000076
1	-0.001747
2	-0.005144

Coefficient	Value
8	-0.035667
9	-0.116753
10	-0.157348



**Table 11-1**

Coefficient	Value
3	-0.004424
4	0.007745
5	0.029610
6	0.043940
7	0.025852

Coefficient	Value
11	-0.088484
12	0.123414
13	0.442748
14	0.767329
15	0.972149

### Duplicating the First 16 Coefficients Using Mirror Table

In a windowed sinc function filter, the second half of the coefficients are identical to the first half in reverse order. The signal generator provides a mirror table function that automatically duplicates the existing coefficient values in the reverse order.

1. Press **Mirror Table**. The last 16 coefficients (16 through 31) are automatically generated and the first of these coefficients (number 16) highlights, as shown in [Figure 11-14 on page 284](#).

**Figure 11-14**

FIR table coefficient values, may be from the factory default values or entered by the user.

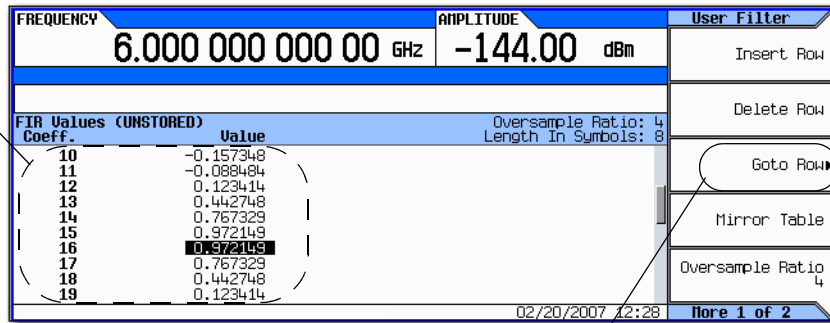

Use the Goto Row menu to move around and make changes to the FIR Values coefficient table.

For details on each key, use key help as described on [page 42](#).

### Setting the Oversample Ratio

**NOTE** Modulation filters must be real and have an oversample ratio (OSR) of two or greater.

The oversample ratio (OSR) is the number of filter coefficients per symbol. Acceptable values range from 1 through 32; the maximum combination of symbols and oversampling ratio allowed by the table editor is 1024. The instrument hardware, however, is actually limited to 32 symbols, an oversample ratio between 4 and 16, and 512 coefficients. So if you enter more than 32 symbols or 512 coefficients, the instrument is unable to use the filter. If the oversample ratio is different from the internal, optimally selected one, then the filter is automatically resampled to an optimal oversample ratio.

For this example, the desired OSR is 4, which is the default, so no action is necessary.

### Displaying a Graphical Representation of the Filter

The signal generator has the capability of graphically displaying the filter in both time and frequency dimensions.

1. Press **More 1 of 2 > Display FFT** (fast Fourier transform).

Refer to [Figure 11-15 on page 285](#).

Figure 11-15

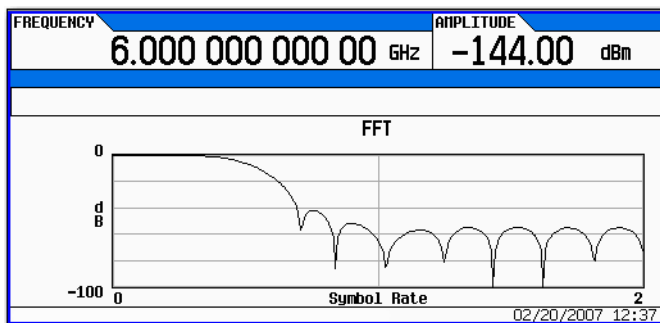

For details on each key, use key help as described on [page 42](#).

2. Press **Return**.
3. Press **Display Impulse Response**.

Refer to [Figure 11-16](#).

Figure 11-16

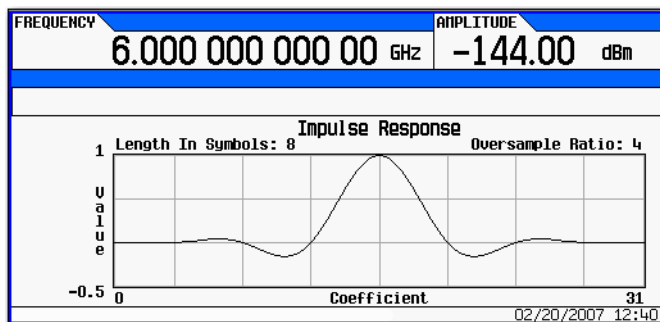

For details on each key, use key help as described on [page 42](#).

4. Press **Return** to return to the menu keys.

### Storing the Filter to Memory

Use the following steps to store the file.

1. Press **Load/Store > Store To File**. The catalog of FIR files appears along with the amount of memory available.
2. As described in [Storing, Loading, and Playing a Waveform Segment](#) on page 144, name and store this file as `FIR_1`.

The `FIR_1` file is the first file name listed. (If you have previously stored other FIR files, additional file names are listed below `FIR_1`.) The file type is FIR and the size of the file is 260 bytes. The amount of memory used is also displayed. The number of files that can be saved depends on the size of the files and the amount of memory used. Refer to [Figure 11-17](#).

Figure 11-17

FREQUENCY		AMPLITUDE		List Load/Store	
6.000 000 000 00 GHz		-144.00 dBm		Load From Selected File	
Catalog of FIR Files in Int Storage		30MB used 468MB free		Store To File	
File Name	Type	Size	modified	Delete File	
1 FIR_1	FIR	260	02/20/07 12:46	Goto Row	
2 FIR_2	FIR	28	02/20/07 12:46		
				02/20/2007 12:47	

Catalog displays FIR files that have been previously saved by the user.

For details on each key, use key help as described on page 42.

These keys manage the table of DMOD files in internal storage.

Memory is also shared by instrument state files and list sweep files.

This filter can now be used to customize a modulation format or it can be used as a basis for a new filter design.

## Modifying a FIR Filter Using the FIR Table Editor

FIR filters stored in signal generator memory can easily be modified using the FIR table editor. You can load the FIR table editor with coefficient values from user-defined FIR files stored in non-volatile memory or from one of the default FIR filters. Then you can modify the values and store the new files.

## Loading the Default Gaussian FIR File

Figure 11-18 Loading the Default Gaussian FIR File

Mode > ARB Custom Modulation > Single Carrier Setup

For details on each key, use key help as described on page 42.

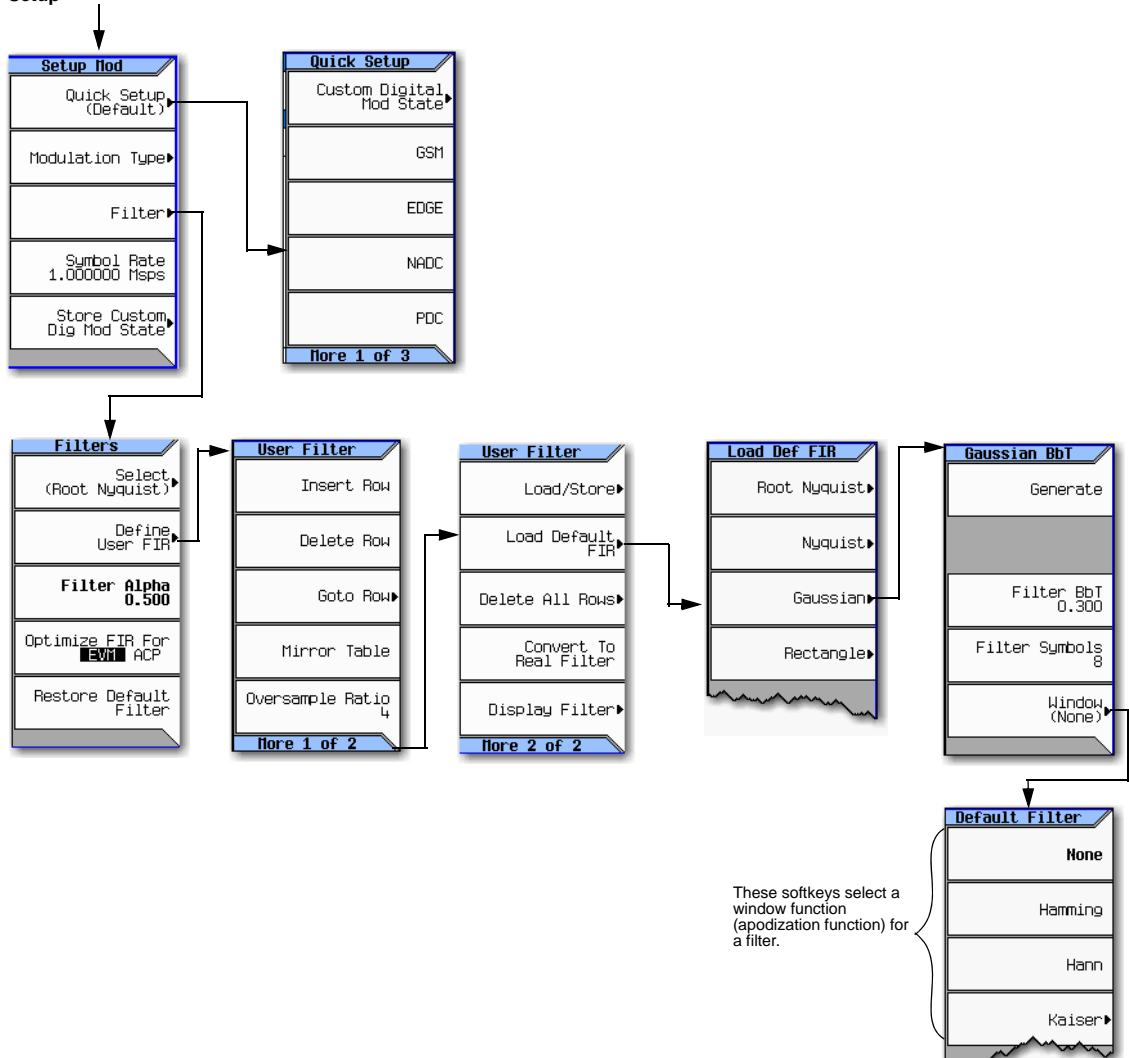

1. Press **Preset**.
2. Press **Mode > ARB Custom Modulation > Single Carrier Setup > Quick Setup > NADC**.
3. Press **Filter > Define User FIR > More 1 of 2 > Load Default FIR > Gaussian**.
4. Press **Filter BbT > 0.300 > Enter**.

5. Press **Filter Symbols > 8 > Enter**.
6. Press **Generate**.

---

**NOTE** The actual oversample ratio during modulation is automatically selected by the instrument. A value between 4 and 16 is chosen dependent on the symbol rate, the number of bits per symbol of the modulation type, and the number of symbols.

---

7. Press **Display Impulse Response** (refer to [Figure 11-19](#)).

Figure 11-19

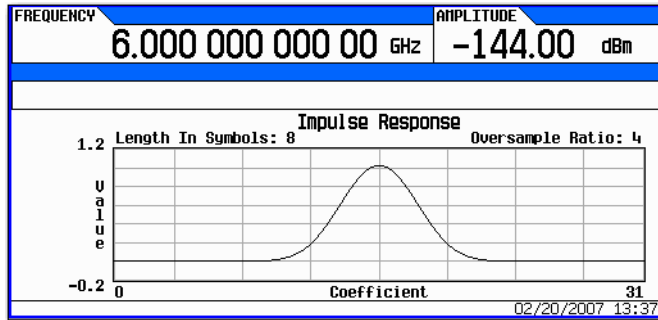

For details on each key, use key help as described on [page 42](#).

8. Press **Return**.

### Modifying the Coefficients

1. Using the front panel arrow keys, highlight coefficient 15.
2. Press **0 > Enter**.
3. Press **Display Impulse Response**.

Figure 11-20

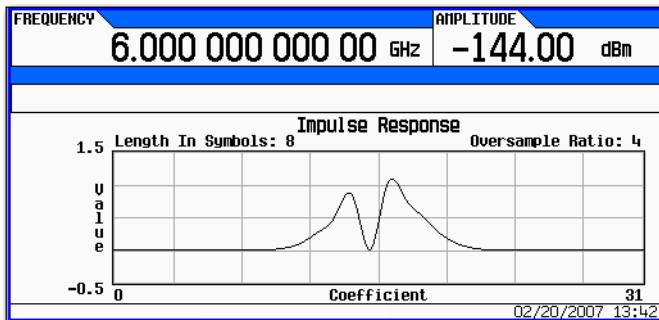

For details on each key, use key help as described on [page 42](#).

Refer to [Figure 11-20 on page 288](#). The graphic display can provide a useful troubleshooting tool (in this case, it indicates that a coefficient value is missing, resulting in an improper Gaussian response).

4. Press **Return**.
5. Highlight coefficient 15.
6. Press **1 > Enter**.

### Storing the Filter to Memory

The maximum file name length is 23 characters (alphanumeric and special characters).

1. Press **Load/Store > Store To File**.
2. Name the file NEWFIR2.
3. Press **Enter**.

The contents of the current FIR table editor are stored to a file in non-volatile memory and the catalog of FIR files is updated to show the new file.

### Differential Encoding

Differential encoding is a digital-encoding technique whereby a binary value is denoted by a signal *change* rather than a particular signal state. Using differential encoding, binary data in any user-defined I/Q or FSK modulation can be encoded during the modulation process via symbol table offsets defined in the Differential State Map.

For example, consider the signal generator's default 4QAM I/Q modulation. With a user-defined modulation based on the default 4QAM template, the I/Q Values table editor contains data that represent four symbols (00, 01, 10, and 11) mapped into the I/Q plane using two distinct values, 1.000000 and -1.000000. The following illustration shows the 4QAM modulation in the I/Q Values table editor.

FREQUENCY		RF OFF	User Mod Type
6.000 000 000 00 GHz		-144.00 dBm	Load/Store▶
			Load Default, I/Q Map▶
			Delete All Rows▶
			Differential Encoding Off On
			Configure Differential Encoding▶
*** DEMO CODE ***			Page 2 of 2

I/Q Values Data	I Value	Q Value
00000000	1.000000	1.000000
00000001	-1.000000	1.000000
00000010	-1.000000	-1.000000
00000011	1.000000	-1.000000

The following illustration shows a 4QAM modulation I/Q State Map.

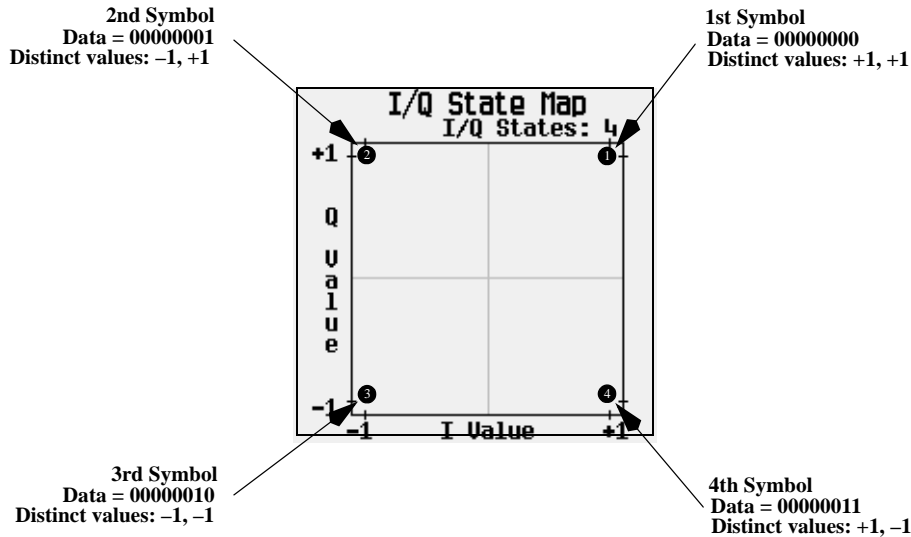

Differential encoding employs relative offsets between the states in the symbol table to encode user-defined modulation schemes. The Differential State Map table editor is used to introduce symbol table offset values which in turn cause transitions through the I/Q State Map based on their associated data value. Whenever a data value is modulated, the offset value stored in the Differential State Map is used to encode the data by transitioning through the I/Q State Map in a direction and distance defined by the symbol table offset value.

Entering a value of +1 will cause a 1-state forward transition through the I/Q State Map, as shown in the following illustration.

---

**NOTE** The following I/Q State Map illustrations show all of the possible state transitions using a particular symbol table offset value. The actual state-to-state transition would depend upon the state in which the modulation had started.

---

As an example, consider the following data/symbol table offset values.

**Table 11-2**

Data	Offset Value
00000000	+1
00000001	-1



**Table 11-2**

Data	Offset Value
00000010	+2
00000011	0

---

**NOTE** The number of bits per symbol can be expressed using the following formula. Because the equation is a ceiling function, if the value of  $x$  contains a fraction,  $x$  is rounded up to the next whole number.

$$x = \lceil \log_2(y) \rceil$$

Where  $x$  = bits per symbol, and  $y$  = the number of differential states.

---

These symbol table offsets will result in one of the transitions, as shown.

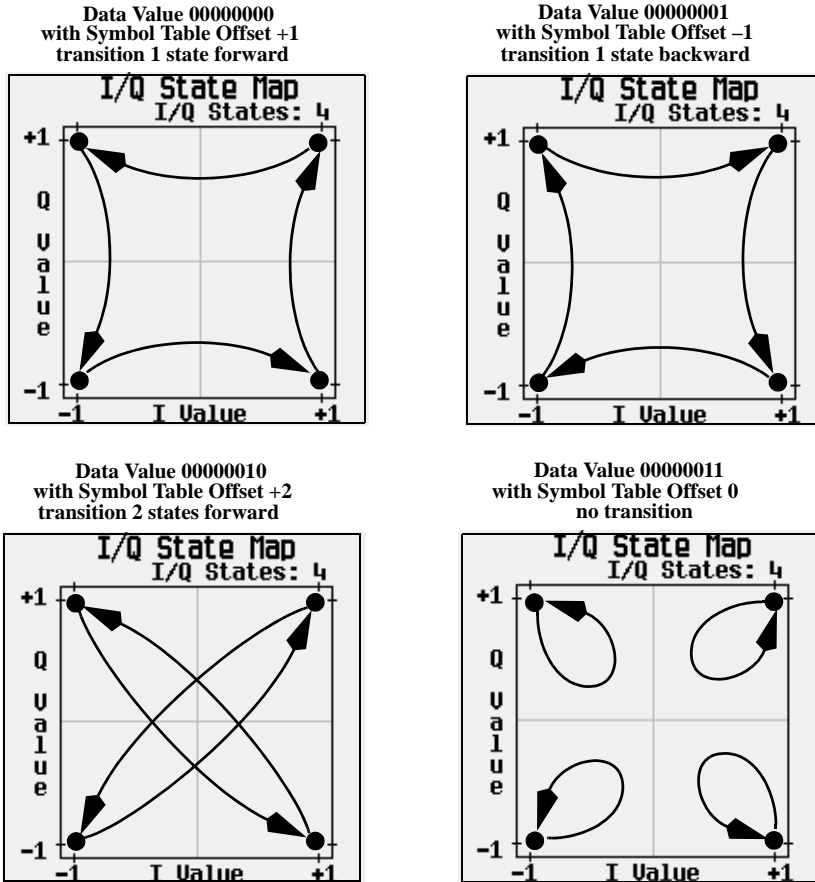

When applied to the user-defined default 4QAM I/Q map, starting from the 1st symbol (data 00), the differential encoding transitions for the data stream (in 2-bit symbols) 0011100001 appear in the following illustration.

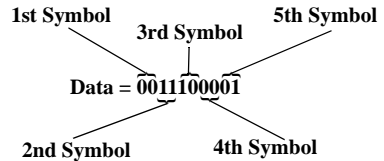
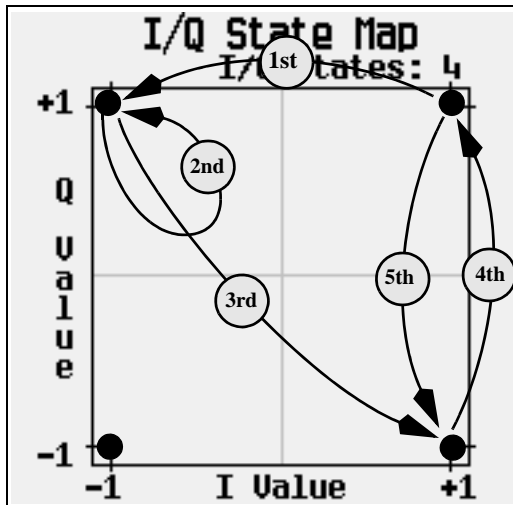

Data Value	Symbol Table Offset
00	+1
01	-1
10	+2
11	+0

As you can see from the previous illustration, the 1st and 4th symbols, having the same data value (00), produce the same state transition (forward 1 state). In differential encoding, symbol values do not define location; they define the direction and distance of a *transition* through the I/Q State Map.

## Using Differential Encoding

The signal generator's Differential State Map table editor enables you to modify the differential state map associated with user-defined I/Q and user-defined FSK modulations. In this procedure, you create a user-defined I/Q modulation and then configure, activate, and apply differential encoding to the user-defined modulation. For more information, see [“Differential Encoding” on page 289](#).

### Configuring User-Defined I/Q Modulation

1. Press **Preset**.
2. Perform the following keypad sequence required for your format type.

#### For Custom Format

Press **Mode > ARB Custom Modulation > Single Carrier Setup > Modulation Type > Define User I/Q > More 1 of 2 > Load Default I/Q Map > QAM > 4QAM**

**For TMDA Formats**

Press **Mode > ARB Custom Modulation > Single Carrier Setup > Quick Setup (desired format) > Modulation Type > Define User I/Q > More 1 of 2 > Load Default I/Q Map > QAM > 4QAM**

This loads a default 4QAM I/Q modulation and displays it in the I/Q table editor.

The default 4QAM I/Q modulation contains data that represent 4 symbols (00, 01, 10, and 11) mapped into the I/Q plane using 2 distinct values (1.000000 and -1.000000). These 4 symbols will be traversed during the modulation process by the symbol table offset values associated with each symbol of data. Refer to [Figure 11-21](#).

**Figure 11-21**

FREQUENCY		RF OFF	User Mod Type
6.000 000 000 00 GHz		-144.00 dBm	Load/Store▶
			Load Default I/Q Map▶
			Delete All Rows▶
			Differential Encoding Off On
			Configure Differential Encoding▶
			More 2 of 2
I/Q Values Data	I Value	Q Value	
00000000	1.000000	1.000000	
00000001	-1.000000	1.000000	
00000010	-1.000000	-1.000000	
00000011	1.000000	-1.000000	

**Accessing the Differential State Map Table Editor**

Press **Configure Differential Encoding**.

This opens the Differential State Map table editor, as shown. At this point, you see the data for the 1st symbol (00000000) and the cursor prepared to accept an offset value. You are now prepared to create a custom differential encoding for the user-defined default 4QAM I/Q modulation. Refer to [Figure 11-22 on page 294](#).

**Figure 11-22**

FREQUENCY		RF OFF	Diff Encode
6.000 000 000 00 GHz		-144.00 dBm	Edit Item
			Insert Row
Differential State Map (UNSTORED)			Delete Row
Data	Symbol Table Offset		Goto Row▶
00000000			Delete All Rows▶

### Editing the Differential State Map

1. Press **1** > **Enter**.

This encodes the first symbol by adding a symbol table offset of 1. The symbol rotates *forward* through the state map by 1 value when a data value of 0 is modulated.

2. Press +/- > **1** > **Enter**.

This encodes the second symbol by adding a symbol table offset of -1. The symbol rotates *backward* through the state map by 1 value when a data value of 1 is modulated.

---

**NOTE** At this point, the modulation has one bit per symbol. For the first two data values (00000000 and 00000001) only the last bits (the 0 and the 1, respectively) are significant.

---

3. Press **2** > **Enter**.

This encodes the third symbol by adding a symbol table offset of 2. The symbol rotates *forward* through the state map by 2 values when a data value of 10 is modulated.

4. Press **0** > **Enter**.

This encodes the fourth symbol by adding a symbol table offset of 0. The symbol does *not* rotate through the state map when a data value of 11 is modulated.

---

**NOTE** At this point, the modulation has two bits per symbol. For the data values 00000000, 00000001, 00000010, 00000011, the symbol values are 00, 01, 10, and 11 respectively.

---

### Applying Custom Differential Encoding

Press **Return** > **Differential Encoding Off On**.

This applies the custom differential encoding to a user-defined modulation.

---

**NOTE** Notice that (UNSTORED) appears next to Differential State Map on the signal generator's display. Differential state maps are associated with the user-defined modulation for which they were created.

In order to save a custom differential state map, you must store the user-defined modulation for which it was designed. Otherwise the symbol table offset data is purged when you press the **Confirm Exit From Table Without Saving** softkey when exiting from the I/Q or FSK table editor.

---



---

# 12 Multitone and Two–Tone Waveforms (Option 430)

---

**NOTE** For the N5162A the softkey menus and features mentioned in this guide are only available through the Web–Enabled MXG or SCPI commands. For information on the Web–Enabled MXG, refer to the *Installation Guide*, the *Programming Guide*, and to the *SCPI Command Reference*.

---

Before using this information, you should be familiar with the basic operation of the signal generator. If you are not comfortable with functions such as setting the power level and frequency, refer to [Basic Operation](#) on page 41 and familiarize yourself with the information in that chapter.

This feature is available only in N5162A/82A Agilent MXG Vector Signal Generators with Option 430. Option 430 requires Option 651, 652, or 654.

## Creating a Custom Two–Tone Waveform

Using the Two–Tone menu, you can define, and modify user–defined Two–Tone waveforms. Two–Tone waveforms are generated by the dual arbitrary waveform generator.

The section [Using Two–Tone Modulation](#) on page 298 teaches you how to perform the following tasks:

- [Creating a Two–Tone Waveform](#) on page 299
- [Viewing a Two–Tone Waveform](#) on page 300
- [Minimizing Carrier Feedthrough](#) on page 301
- [Changing the Alignment of a Two–Tone Waveform](#) on page 302

## Creating a Custom Multitone Waveform

Using the Multitone Setup table editor, you can define, modify and store user–defined multitone waveforms. Multitone waveforms are generated by the dual arbitrary waveform generator.

The [Using Multitone Modulation](#) on page 304 teaches you how to perform the following tasks:

- [Initializing the Multitone Setup Table Editor](#) on page 304
- [Configuring Tone Powers and Tone Phases](#) on page 305
- [Removing a Tone](#) on page 305
- [Generating the Waveform](#) on page 305
- [Configuring the RF Output](#) on page 306

## Using Two-Tone Modulation

In the following sections, this chapter describes the two-tone mode, which is available only in N5162A/82A Agilent MXG Vector signal generators with Option 430:

- [Creating a Two-Tone Waveform](#) on page 299
- [Viewing a Two-Tone Waveform](#) on page 300
- [Minimizing Carrier Feedthrough](#) on page 301
- [Changing the Alignment of a Two-Tone Waveform](#) on page 302

See also: [Saving a Waveform's Settings & Parameters](#) on page 151

---

**NOTE** For more information about two-tone waveform characteristics, and the two-tone standard, download *Application Note 1410* from our website by going to <http://www.agilent.com> and searching for “AN 1410” in Test & Measurement.

---



## Two-Tone Modulation Softkeys

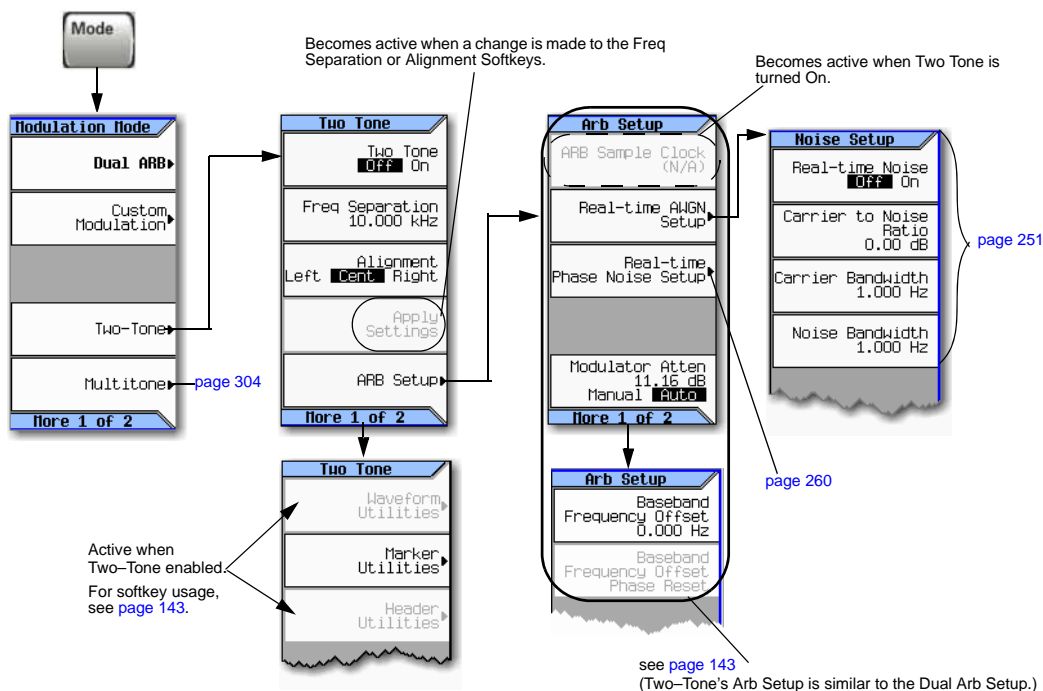

**Exceptions:**

- > No Waveform Runtime Scaling softkey,
- > No Multi-BBG Sync Setup softkey, and
- > No DAC Over-Range Protection softkey

For details on each key, use key help as described on page 42.

## Creating a Two-Tone Waveform

This procedure describes how to create a basic, centered, two-tone waveform.

1. Preset the signal generator.
2. Set the signal generator RF output frequency to 6 GHz.
3. Set the signal generator RF output amplitude to -10 dBm.
4. Press **Mode > Two-Tone > Freq Separation > 10 > MHz**.
5. Press **Two Tone Off On** to On.
6. Turn on the RF output.

The two-tone signal is now available at the signal generator RF OUTPUT connector. [Figure 12-1 on page 300](#) shows what the signal generator display should look like after all steps have been completed. Notice that the T-TONE, I/Q, annunciators are displayed; the RF ON, MOD ON are on; and the parameter settings for the signal are shown in the status area of the signal generator display.

Figure 12-1

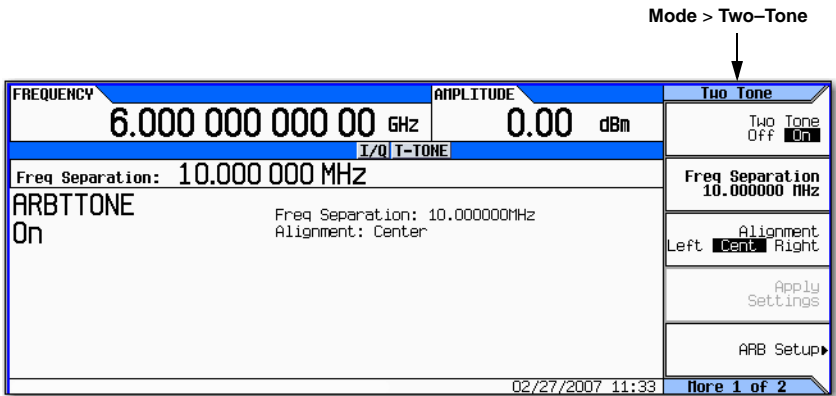

### Viewing a Two-Tone Waveform

This procedure describes how to configure the spectrum analyzer to view a two-tone waveform and its IMD products. Actual key presses will vary, depending on the model of spectrum analyzer you are using.

1. Preset the spectrum analyzer.
2. Set the carrier frequency to 6 GHz.
3. Set the frequency span to 60 MHz.
4. Set the amplitude for a 10 dB scale with a -10 dBm reference.
5. Adjust the resolution bandwidth to sufficiently reduce the noise floor to expose the IMD products. A 9.1 kHz setting was used in our example.
6. Turn on the peak detector.
7. Set the attenuation to 4 dB, so you're not overdriving the input mixer on the spectrum analyzer.

You should now see a two-tone waveform with a 6 GHz center carrier frequency that is similar to the one shown in [Figure 12-2 on page 301](#). You will also see IMD products at 10 MHz intervals above and below the generated tones, and a carrier feedthrough spike at the center frequency with carrier feedthrough distortion products at 10 MHz intervals above and below the center carrier frequency.

Figure 12-2

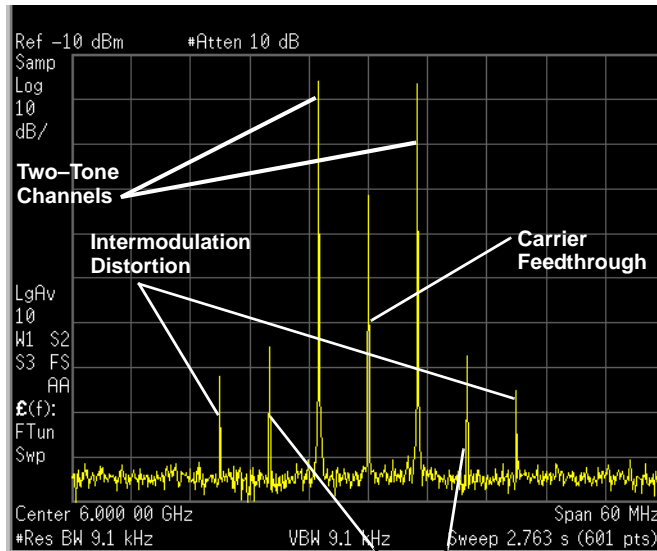

For details on each key, use key help as described on [page 42](#).

**Carrier Feedthrough  
Distortion**

## Minimizing Carrier Feedthrough

This procedure describes how to minimize carrier feedthrough and measure the difference in power between the tones and their intermodulation distortion products. Before beginning this procedure, it is important that a recent I/Q calibration has been performed on the instrument. The procedure for performing an I/Q calibration (refer to “[I/Q Calibration](#)” on [page 205](#)).

This procedure builds upon the previous procedure.

1. On the spectrum analyzer, set the resolution bandwidth for a sweep rate of about 100 to 200 ms. This will allow you to dynamically view the carrier feedthrough spike as you make adjustments.
2. On the signal generator, press **I/Q > I/Q Adjustments > I/Q Adjustments Off On** to On.
3. Press **Internal Baseband Adjustments > I Offset** and turn the rotary knob while observing the carrier feedthrough with the spectrum analyzer. Changing the I offset in the proper direction will reduce the feedthrough level. Adjust the level as low as possible.
4. Press **Q Offset** and turn the rotary knob to further reduce the carrier feedthrough level.
5. Repeat steps 3 and 4 until you have reached the lowest possible carrier feedthrough level.
6. On the spectrum analyzer, return the resolution bandwidth to its previous setting.
7. Turn on waveform averaging.

8. Create a marker and place it on the peak of one of the two tones.
9. Create a delta marker and place it on the peak of the adjacent intermodulation product, which should be spaced 10 MHz from the marked tone.
10. Measure the power difference between the tone and its distortion product.

You should now see a display that is similar to the one shown in [Figure 12-3 on page 302](#). Your optimized two-tone signal can now be used to measure the IMD products generated by a device-under-test.

Note that carrier feedthrough changes with time and temperature. Therefore, you will need to periodically readjust your I and Q offsets to keep your signal optimized.

**Figure 12-3**

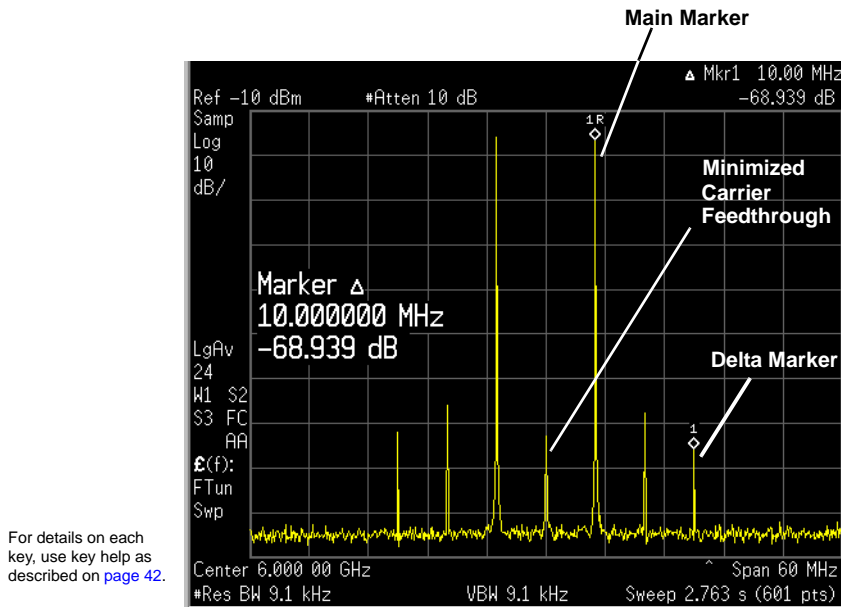

## Changing the Alignment of a Two-Tone Waveform

This procedure describes how to align a two-tone waveform left or right, relative to the center carrier frequency. Because the frequency of one of the tones is the same as the carrier frequency, this alignment typically hides any carrier feedthrough. However, image frequency interference caused by left or right alignment may cause minor distortion of the two-tone signal. This procedure builds upon the previous procedure.

1. On the signal generator, press **Mode > Two Tone > Alignment Left Cent Right** to Left.
2. Press **Apply Settings** to regenerate the waveform.

**NOTE** Whenever a change is made to a setting while the two-tone generator is operating (**Two Tone Off On** set to On), you must apply the change by pressing the **Apply Settings** softkey before the updated waveform will be generated. When you apply a change, the baseband generator creates a two-tone waveform using the new settings and replaces the existing waveform in ARB memory.

- On the spectrum analyzer, temporarily turn off waveform averaging to refresh your view more quickly. You should now see a left-aligned two-tone waveform that is similar to the one shown in Figure 12-4.

Figure 12-4

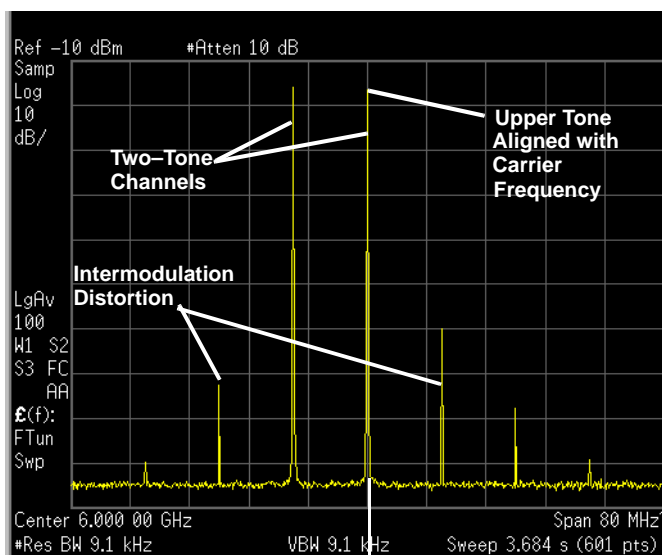

For details on each key, use key help as described on [page 42](#).

Carrier  
Frequency

## Using Multitone Modulation

### Multitone Modulation Softkeys

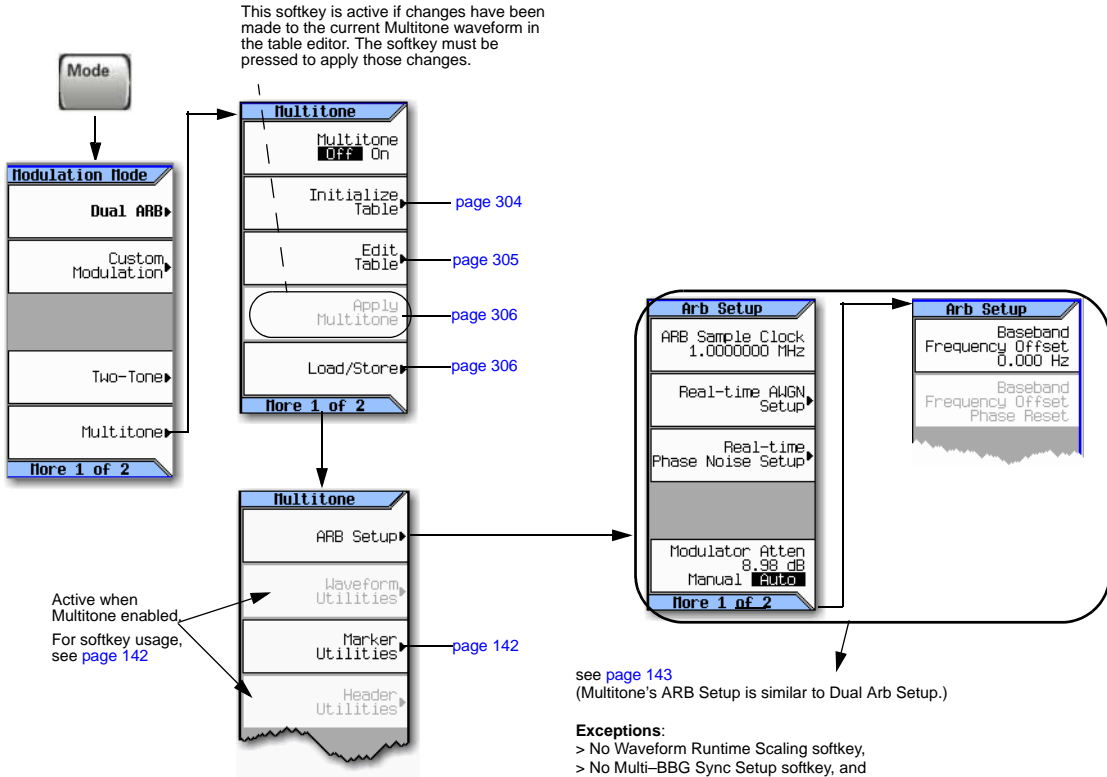

For details on each key, use key help as described on page 42.

### Initializing the Multitone Setup Table Editor

1. Press **Preset**.
2. Press **Mode > Multitone**
3. Press **Initialize Table > Number of Tones > 5 > Enter**.
4. Press **Freq Spacing > 20 > kHz**.

Figure 12-5

FREQUENCY		AMPLITUDE		Init Tones	
6.000 000 000 00 GHz		-144.00 dBm		Number Of Tones 5	
Number of Tones: 5				Freq Spacing 20.000 kHz	
Multitone Setup: default (UNSTORED)					
Tone	Freq Offset	Power	Phase	State	
1	-40.000 kHz	0.00 dB	0	On	
2	-20.000 kHz	0.00 dB	0	On	
3	0.000 kHz	0.00 dB	0	On	
4	20.000 kHz	0.00 dB	0	On	
5	40.000 kHz	0.00 dB	0	On	

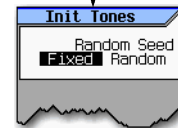

The Random Seed softkey that affects the Multitone's phase values is not used in the following examples and is shown for reference, only.

For details on each key, use key help as described on [page 42](#).

5. Press **Done**.

You now have a multitone setup with five tones spaced 20 kHz apart. The center tone is placed at the carrier frequency, while the other four tones are spaced in 20 kHz increments from the center tone.

### Configuring Tone Powers and Tone Phases

1. Highlight the value (0 dB) in the Power column for the tone in row 2.
2. Press **Edit Table > Edit Item > -4.5 > dB**.
3. Highlight the value (0) in the Phase column for the tone in row 2.
4. Press **Edit Item > 123 > deg**.

### Removing a Tone

1. Highlight the value (On) in the State column for the tone in row 4.
2. Press **Toggle State**.

### Generating the Waveform

Press **Return > Multitone Off On** until On is highlighted.

This generates the multitone waveform with the parameters defined in the previous sections. During waveform generation, the M-TONE and I/Q annunciators activate and the multitone waveform is stored in volatile ARB memory. The waveform is now modulating the RF carrier.

## Configuring the RF Output

1. Set the RF output frequency to 100 MHz.
2. Set the output amplitude to 0 dBm.
3. Press **RF On/Off**.

The multitone waveform is now available at the signal generator's RF OUTPUT connector.

## Applying Changes to an Active Multitone Signal

If the multitone generator is currently in use (**Multitone Off On** set to On) while changes are made in the Multitone Setup table editor, you must *apply* the changes before the updated waveform will be generated.

From the Multitone Setup table editor, press the following key to apply the changes and generate a multitone waveform based on the updated values: **Apply Multitone**

## Storing a Multitone Waveform

In this example, you learn how to store a multitone waveform. If you have not created a multitone waveform, complete the steps in the previous section, [Creating a Custom Multitone Waveform](#) on page 297.

1. Press **Load/Store > Store To File**.

If there is already a file name from the Catalog of MTONE Files occupying the active entry area, press the following keys (see [page 43](#)):

**Edit Keys > Clear Text**

2. Enter a file name (for example, 5TONE) using the alpha keys and the numeric keypad with a maximum length of 23 characters (see [page 43](#)).
3. Press **Enter**.

The multitone waveform is now stored in the Catalog of MTONE Files.

---

**NOTE** The RF output amplitude, frequency, and operating state settings are not stored as part of a multitone waveform file. Similarly, the multitone settings are not stored as part of the instrument state. Therefore, in most cases you should save both the instrument states and the multitone settings to be able to restore all of your settings later.

---



### Recalling a Multitone Waveform

Using this procedure, you learn how to recall a multitone waveform from the signal generator's memory catalog.

If you have not created and stored a multitone waveform, complete the steps in the previous sections, [Creating a Custom Multitone Waveform](#) on page 297 and [Storing a Multitone Waveform](#) on page 306, then preset the signal generator to clear the stored multitone waveform from volatile ARB memory.

1. Press **Mode > Multitone**.
2. Press **Load/Store**.
3. Highlight the desired file (for example, 5TONE).
4. Press **Load From Selected File > Confirm Load From File**.
5. Press **Multitone Off On** until On is highlighted.

The firmware generates the multitone waveform in ARB memory. After waveform generation, the multitone waveform is available to be modulated on the RF output.

For instruction on configuring the RF output, see [Configuring the RF Output](#) on page 306.



# 13 Working in a Secure Environment

**NOTE** For the N5161A/62A the softkey menus and features mentioned in this guide are only available through the Web-Enabled MXG or SCPI commands. For information on the Web-Enabled MXG, refer to the *Installation Guide*, the *Programming Guide*, and to the *SCPI Command Reference*.

- [Understanding Memory Types](#) on page 309
- [Removing Data from Memory \(Option 006 Only\)](#) on page 312
- [Using the Secure Display \(Option 006 Only\)](#) on page 315

## Understanding Memory Types

The signal generator has several memory types, and each is used to store a specific type of data. Before removing sensitive data, you should understand how each memory type is used. The following tables describe each memory type used in the base instrument, and optional baseband generator.

**Table 13-1 Base Instrument Memory**

Memory Type and Size	Writable During Normal Operation?	Data Retained When Powered Off?	Purpose/Contents	Data Input Method	Location in Instrument and Remarks
Main Memory (RAM) 32 MB	Yes	No	firmware operating memory no user data	operating system	CPU board, not battery backed.
Main Memory (Flash) 8 MB	Yes	Yes	factory calibration/configuration data <sup>a</sup> user file system, which includes flatness calibration, instrument states, and sweep lists	firmware upgrades and user-saved data <sup>a</sup>	CPU board (same chip as firmware memory, but managed separately)  Because this memory chip contains 8 MB of user data (described here) and 8 MB of firmware memory, a full-chip erase is not desirable. User data areas are selectively and completely sanitized when you perform the <b>Erase and Sanitize</b> function.

**Table 13-1 Base Instrument Memory (Continued)**

Memory Type and Size	Writable During Normal Operation?	Data Retained When Powered Off?	Purpose/Contents	Data Input Method	Location in Instrument and Remarks
Firmware Memory (Flash) 8 MB	No	Yes	main firmware image	factory installed or firmware upgrade	CPU board (same chip as main flash memory, but managed separately)  During normal operation, this memory cannot be overwritten. It is only overwritten during the firmware installation or upgrade process.  Because this memory chip contains 8 MB of user data and 8 MB of firmware memory (described here), a full-chip erase is not desirable. User data areas are selectively and completely sanitized when you perform the <b>Erase and Sanitize</b> function.
Bootrom Memory (EEPROM) 8 kB	No	Yes	CPU bootup parameters no user data	factory programmed	CPU board  During normal operation, this memory cannot be overwritten or erased except for LAN configuration. This read-only data is programmed at the factory.
	Yes	Yes	LAN configuration	Front panel entry or remotely	
Calibration Data (Flash) 256 kB	No	Yes	factory calibration/configuration data backup no user data	factory or service only	RF Board
LCD Display Memory (RAM) 160 kB	No	No	display buffer	operating system	RF board, not battery backed.
Front Panel Memory (Flash) 32 kB	No	No	front panel keyboard controller firmware no user data	operating system	Front Panel board

<sup>a</sup>Analog instruments only

**Table 13-2 Baseband Generator Memory (Options 651,652, 654)**

Memory Type and Size	Writable During Normal Operation?	Data Retained When Powered Off?	Purpose/Contents	Data Input Method	Remarks
Waveform Memory (RAM) ≤ 320 MB	Yes	No	waveforms (including header and marker data)	normal user operation	Not battery backed.
Persistent Memory (Flash) <sup>a</sup> 4 GB	Yes	Yes	all user data	normal user operation	User data is completely sanitized when you perform the <b>Erase and Sanitize</b> function.
Calibration Data Memory (Flash) 128 kB	No	Yes	no user data	factory or service only	

<sup>a</sup>For serial numbers <MY4818xxxx, US4818xxxx, and SG4818xxxx, the persistent memory value = 512 MB.

## Removing Data from Memory (Option 006 Only)

When moving the signal generator from a secure development environment, there are several security functions you can use to remove classified proprietary information from the instrument. Security functions also have equivalent SCPI commands for remote operation (“System Subsystem (:SYSTEM)” commands; refer to the *SCPI Command Reference*)

---

**CAUTION** The signal generator has several memory types (described in [Table 13-1 on page 309](#), and [Table 13-2 on page 311](#)), and each is used to store a specific type of data. Before removing sensitive data, understand how each memory type is used.

---

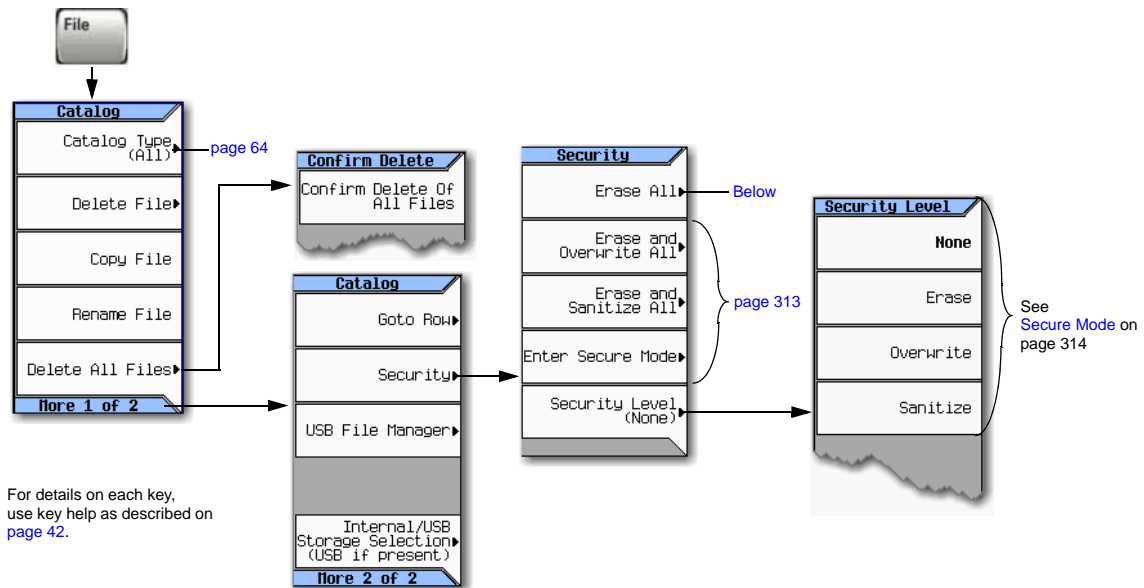

### Erase All

- Removes: All user files, user flatness calibrations, user I/Q calibrations
- Resets: All table editors with original factory values, ensuring that user data and configurations are not accessible or viewable
- Does Not: Sanitize memory
- Time to Erase: typically < 1 minute, depending on the number of files.
- To Start: Press **File > More > Security > Erase All > Confirm Erase**

---

**NOTE** This is not **File > Delete All Files**, which deletes all user files but does not reset table editors.

---

## Erase and Overwrite All

This performs the same actions as Erase All, plus it clears and overwrites the various memory types in compliance with the National Industry Security Program Operating Manual (NISPOM) DoD 5220.22-M.

CPU Flash Overwrites all addressable locations with random characters and then erases the flash blocks. This accomplishes the same purpose as a chip erase. System files are restored after erase.

To Start: Press **File > More > Security > Erase and Overwrite All > Confirm Erase**

## Erase and Sanitize All

This performs the same actions as Erase and Overwrite All and then adds more overwriting actions. After executing this function, you must manually perform the additional steps described below for the sanitization to comply with the National Industry Security Program Operating Manual (NISPOM) DoD 5220.22-M.

CPU Flash Overwrites all addressable locations with random characters and then erases the flash blocks. This accomplishes the same purpose as a chip erase. System files are restored after erase.

BBG Persistent Memory (Flash) (*Vector instruments only*) Overwrites all addressable locations with random characters and then erases the flash blocks. This accomplishes the same purpose as a chip erase. System files are restored after erase.

To Start: Press **File > More > Security > Erase and Sanitize All > Confirm Sanitize**

## Removing Persistent State Information Not Removed During Erase

### Persistent State

The persistent state settings contain instrument setup information that can be toggled within predefined limits such as display intensity, contrast and the GPIB address. In vector models, the user IQ cal is also saved in this area.

The following key presses or SCPI commands can be used to clear the IQ cal file and to set the operating states that are not affected by a signal generator power-on, preset, or \*RST command to their factory default:

### Instrument Setup

- On the Agilent MXG front panel, press: **Utility > Power On/Preset > Restore System Settings to Default Values > Confirm Restore Sys Settings to Default Values**
- Or send this command to the Agilent MXG: `:SYSTEM:PRESet:PERSistent`

## LAN Setup

The LAN setup (hostname, IP address, subnet mask, and default gateway) information is not defaulted with a signal generator power-on or \*RST command. This information can only be changed or cleared by entering new data.

## User IQ Cal File (Vector Models Only)

When a user-defined IQ calibration has been performed, the cal file data is removed by setting the cal file to default, as follows:

- On the front panel, press: **I/Q > I/Q Calibration > Revert to Default Cal Settings**
- Or send this command to the Agilent MXG: `:CAL:IQ:DEF`

## Secure Mode

---

**CAUTION** Once you activate secure mode (by pressing **Confirm**), you cannot deactivate or decrease the security level; the erasure actions for that security level execute at the next power cycle. Once you activate secure mode, you can only increase the security level until you cycle power. For example, you can change **Erase** to **Overwrite**, but not the reverse.

After the power cycle, the security level selection remains the same, but secure mode is not activated.

To avoid the loss of data, GPIB settings, or current user instrument states that have not been permanently saved to non-volatile memory, the MXG should always be powered down either via the MXG's front panel power button or the appropriate SCPI command. MXG's installed in rack systems and powered down with the system rack power switch rather than the MXG's front panel switch display a Error -310 due to the MXG not being powered down correctly.

---

Secure mode automatically applies the selected **Security Level** action the next time the instrument's power cycles.

To Set the Level: Press **File > More > Security > Security Level** and choose from the following:

- **None** = factory preset, no user information is lost
- **Erase** = Erase All
- **Overwrite** = Erase and Overwrite All
- **Sanitize** = Erase and Sanitize All

To Activate: Press **File > More > Security > Enter Secure Mode > Confirm**

The softkey changes to **Secure Mode Activated**.

## Securing a Nonfunctioning Instrument

If the instrument is not functioning and you are unable to use the security functions, you must physically remove the processor board and, for vector instruments, the A4 Memory Chip from the instrument. Once these assemblies are removed, choose one of the following options:

- Discard the board (or boards) and send the instrument to a repair facility. A new board (or boards) will be installed and the instrument will be repaired and calibrated. If the instrument is still under warranty, you will not be charged for new boards.



- If you have another working instrument, install the board (or boards) into that instrument and erase the memory. Then reinstall the board (or boards) back into the nonworking instrument and send it to a repair facility for repair and calibration. If you discover that one or both of the boards do not function in the working instrument, discard the nonfunctioning board and note on the repair order that it caused the instrument failure. If the instrument is still under warranty, you will not be charged for new boards.

For instructions on how to remove and replace boards, refer to the *Service Guide*.

## Using the Secure Display (Option 006 Only)

This function prevents unauthorized personnel from reading the instrument display and tampering with the current configuration through the front panel. The display blanks, except for the message shown in the following figure, and the front panel keys are disabled.

To re-enable the display and front panel keys, cycle the power.

Figure 13-1 Secure Display Softkeys

For details on each key, use key help as described on [page 42](#).

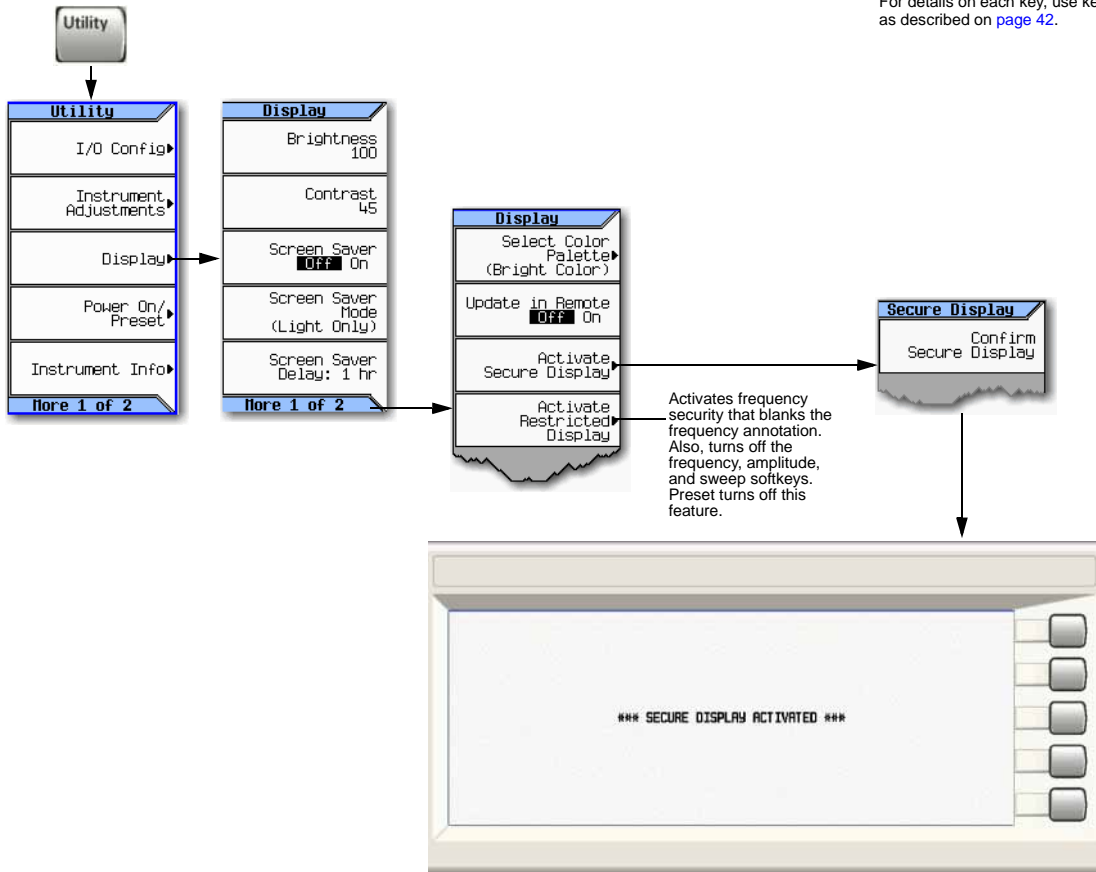

Activates frequency security that blanks the frequency annotation. Also, turns off the frequency, amplitude, and sweep softkeys. Preset turns off this feature.

---

# 14 Troubleshooting

---

**NOTE** For the N5161A/62A the softkey menus and features mentioned in this guide are only available through the Web-Enabled MXG or SCPI commands. For information on the Web-Enabled MXG, refer to the *Installation Guide*, the *Programming Guide*, and to the *SCPI Command Reference*.

---

- [Display](#) on page 318
- [Signal Generator Lock-Up](#) on page 318
- [RF Output](#) on page 318
  - [No RF Output](#)
  - [Power Supply Shuts Down](#)
  - [No Modulation at the RF Output](#)
  - [RF Output Power too Low](#)
  - [Distortion](#)
  - [Signal Loss While Working with a Spectrum Analyzer](#)
  - [Signal Loss While Working with a Mixer](#)
- [Sweep](#) on page 322
  - [Cannot Turn Off Sweep](#)
  - [Sweep Appears Stalled](#)
  - [Incorrect List Sweep Dwell Time](#)
  - [List Sweep Information is Missing from a Recalled Register](#)
  - [Amplitude Does Not Change in List or Step Sweep](#)
- [Internal Media Data Storage](#) on page 323
  - [Instrument State Saved but the Register is Empty or Contains the Wrong State](#)
- [USB Media Data Storage](#) on page 323
  - [Instrument Recognizes USB Media Connection, but Does Not Display Files](#)
- [Preset](#) on page 323
  - [The Signal Generator Does Not Respond](#)
  - [Pressing Preset Performs a User Preset](#)
- [Error Messages](#) on page 324
- [Front Panel Tests](#) on page 325
- [Self Test Overview](#) on page 326
- [Licenses](#) on page 328
- [Contacting Agilent Technologies](#) on page 328
  - [Returning a Signal Generator to Agilent](#)

## Display

### The Display is Too Dark to Read

Both brightness and contrast may be set to minimum. Use the figure in “[Display Settings](#)” on page 26 to locate the brightness and contrast softkeys and adjust their values so that you can see the display.

### The Display Turns Black when Using USB Media

Removing the USB media when the instrument begins to use it can cause the screen to go black. Cycle instrument power.

### Signal Generator Lock–Up

- Ensure that the signal generator is not in remote mode (the R annunciator shows on the display). To exit remote mode and unlock the front panel, press **Local Cancel/(Esc)**.
- Ensure that the signal generator is not in local lockout, which prevents front panel operation. For information on local lockout, refer to the *Programming Guide*.
- If a progress bar appears on the signal generator display, an operation is in progress.
- Preset the signal generator.
- Cycle power on the signal generator.

## RF Output

### No RF Output

- Check the RF ON/OFF LED (shown on [page 5](#)). If it is off, press RF On/Off to turn the output on.
- Ensure that the amplitude is set within the signal generator’s range.
- If the instrument is playing a waveform, ensure that marker polarity and routing settings are correct (see “[Saving Marker Polarity and Routing Settings](#)” on page 158).

### Power Supply Shuts Down

If the power supply does not work, it requires repair or replacement. If you are unable to service the instrument, send the signal generator to an Agilent service center for repair (see “[Contacting Agilent Technologies](#)” on page 328).

### No Modulation at the RF Output

Check both the Mod On/Off LED and the *<modulation>* Off On softkey, and ensure that both are on. See also “[Modulating the Carrier Signal](#)” on page 60.

For digital modulation on a vector signal generator, ensure that the internal I/Q modulator is on (the I/Q annunciator displays).

If using an external modulation source, ensure that the external source is on and that it is operating within the signal generator’s specified limits.

## RF Output Power too Low

- If the AMPLITUDE area of the display shows the OFFS indicator, eliminate the offset:  
Press **Amptd > More 1 of 2 > Amptd Offset > 0 > dB**. See also [“Setting an Output Offset” on page 113](#).
- If the AMPLITUDE area of the display shows the REF indicator, turn off the reference mode:
  1. Press **Amptd > More > Amptd Ref Off On** until Off highlights.
  2. Reset the output power to the desired level.
 See also [“Setting an Output Reference” on page 114](#).
- If you are using the signal generator with an external mixer, see [page 320](#).
- If you are using the signal generator with a spectrum analyzer, see [page 319](#).
- If pulse modulation is on, turn off the ALC, and check that pulse width is within specifications.

## Distortion

If you edit and resave a segment in a waveform sequence, the sequence does not automatically update the RMS value stored in its header. This can cause distortion on the output signal. Display the sequence header information and recalculate the RMS value (see [page 151](#)).

## Signal Loss While Working with a Spectrum Analyzer

---

**CAUTION** To avoid damaging or degrading the performance of the MXG, do not exceed 33 dBm (2W) *maximum* of reverse power levels at the RF input. See also *Tips for Preventing Signal Generator Damage* on [www.agilent.com](http://www.agilent.com).

---

The effects of reverse power can cause problems with the RF output when you use the signal generator with a spectrum analyzer that does not have preselection. Use an unlevelled operating mode (described on [page 110](#)).

A spectrum analyzer can have as much as +5 dBm LO feedthrough at its RF input port at some frequencies. If the frequency difference between the LO feedthrough and the RF carrier is less than the ALC bandwidth, the LO's reverse power can amplitude modulate the signal generator's RF output. The rate of the undesired AM equals the difference in frequency between the spectrum analyzer's LO feedthrough and the signal generator's RF carrier.

Reverse power problems can be solved by using one of the unlevelled operating modes.

See:

- [“ALC Off Mode” on page 110](#)
- and
- [“Power Search Mode” on page 111](#)

## Signal Loss While Working with a Mixer

**CAUTION** To avoid damaging or degrading the performance of the MXG, do not exceed 33 dBm (2W) *maximum* of reverse power levels at the RF input. See also *Tips for Preventing Signal Generator Damage* on [www.agilent.com](http://www.agilent.com).

To fix signal loss at the signal generator's RF output during low-amplitude coupled operation with a mixer, add attenuation and increase the RF output amplitude.

The figure at right shows a configuration in which the signal generator provides a low amplitude signal to a mixer.

The internally leveled signal generator RF output (and ALC level) is  $-8$  dBm. The mixer is driven with an LO of  $+10$  dBm and has an LO-to-RF isolation of  $15$  dB. The resulting  $-5$  dBm LO feedthrough enters the signal generator's RF output connector and arrives at the internal detector.

Depending on frequency, it is possible for most of this LO feedthrough energy to enter the detector. Because the detector responds to its total input power regardless of frequency, this excess energy causes the ALC to reduce the RF output. In this example, the reverse power across the detector is actually greater than the ALC level, which can result in loss of signal at the RF output.

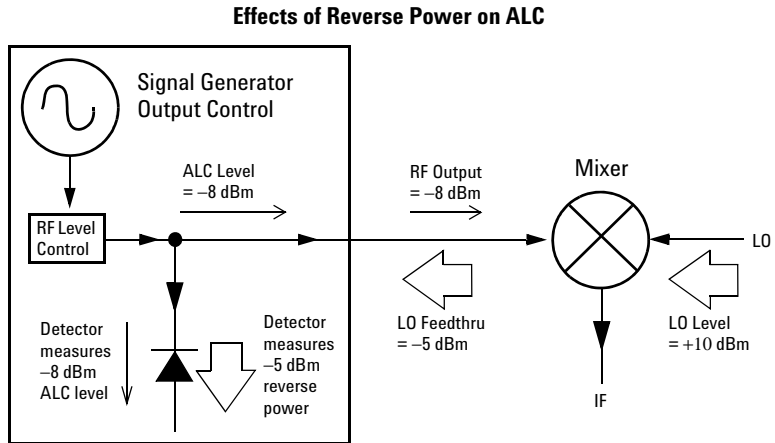

The solution at right shows a similar configuration with the addition of a 10 dB attenuator connected between the RF output of the signal generator and the input of the mixer. The signal generator's ALC level increases to +2 dBm and transmits through a 10 dB attenuator to achieve the required -8 dBm amplitude at the mixer input.

Compared to the original configuration, the ALC level is 10 dB higher while the attenuator reduces the LO feedthrough (and the signal generator's RF output) by 10 dB. Using the attenuated configuration, the detector is exposed to a +2 dBm desired signal versus the -15 dBm undesired LO feedthrough. This 17 dB difference between desired and undesired energy results in a maximum 0.1 dB shift in the signal generator's RF output level.

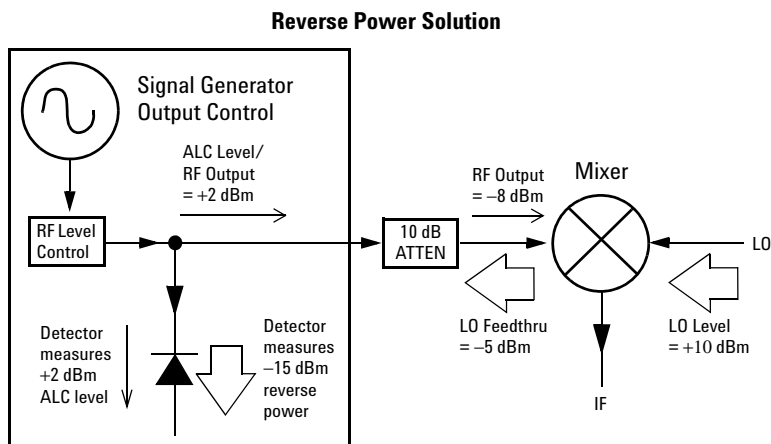

## Sweep

### Cannot Turn Off Sweep

Press **Sweep > Sweep > Off**.

### Sweep Appears Stalled

The current status of the sweep is indicated as a shaded rectangle in the progress bar (see [“Configuring a Swept Output” on page 48](#)). If the sweep appears to stall, check the following:

1. Turn on the sweep with one of the following key sequences:
  - Sweep > Sweep > Freq**
  - Sweep > Sweep > Amptd**
  - Sweep > Sweep > Waveform** (vector instruments only)
2. If the sweep is in single mode, press the **Single Sweep** softkey.
3. If the sweep trigger (indicated by the **Sweep Trigger** softkey) is *not* set to Free Run, set it to Free Run to determine if a missing sweep trigger is blocking the sweep.
4. If the point trigger (indicated by the **Point Trigger** softkey) is *not* set to Free Run, set it to Free Run to determine if a missing point trigger is blocking the sweep.
5. Set the dwell time to one second to determine if the dwell time was set to a value that was too slow or too fast to see.
6. Ensure that you set at least two points in the step sweep or list sweep.

### Incorrect List Sweep Dwell Time

1. Press **Sweep > More > Configure List Sweep**.
2. Check that the list sweep dwell values are accurate.
3. If the dwell values are incorrect, edit them.  
If the dwell values are correct, continue to the next step.
4. Press **More**, and ensure that the **Dwell Type List Step** softkey is set to List.  
If Step is selected, the signal generator sweeps the list points using the dwell time set for step sweep rather than list sweep.

See also [“Configuring a Swept Output” on page 48](#).

### List Sweep Information is Missing from a Recalled Register

List sweep information is not stored as part of the instrument state in an instrument state register. Only the current list sweep is available to the signal generator. You can store list sweep data in the instrument catalog (see [“Loading \(Recalling\) a Stored File” on page 67](#)).

### Amplitude Does Not Change in List or Step Sweep

Verify that sweep type is set to amplitude (Amptd); the amplitude does not change when the sweep type is set to frequency (Freq) or waveform.



## Internal Media Data Storage

### Instrument State Saved but the Register is Empty or Contains the Wrong State

If the register number you intended to use is empty or contains the wrong instrument state, recall register 99. If you selected a register number greater than 99, the signal generator automatically saves the instrument state in register 99.

See also “[Working with Instrument State Files](#)” on page 69.

## USB Media Data Storage

### Instrument Recognizes USB Media Connection, but Does Not Display Files

If the USB media works on other instruments or computers, it may simply be incompatible with the signal generator; try a different USB media. Refer to <http://www.agilent.com/find/mxg> for details on compatible USB media.

## Preset

### The Signal Generator Does Not Respond

If the signal generator does not respond to a preset, the instrument may be in remote mode, which locks the keypad.

To exit remote mode and unlock the preset keys, press **Local Cancel/(Esc)**.

### Pressing Preset Performs a User Preset

This behavior results from the use of a backward-compatible SCPI command. To return the signal generator to normal use, send the command `:SYST:PRESet:TYPE NORM`.

For information on SCPI commands, refer to the *SCPI Command Reference*.

## Error Messages

### Error Message Types

Events do not generate more than one type of error. For example, an event that generates a query error does not generate a device-specific, execution, or command error.

**Query Errors (-499 to -400)** indicate that the instrument's output queue control has detected a problem with the message exchange protocol described in IEEE 488.2, Chapter 6. Errors in this class set the query error bit (bit 2) in the event status register (IEEE 488.2, section 11.5.1). These errors correspond to message exchange protocol errors described in IEEE 488.2, 6.5. In this case:

- Either an attempt is being made to read data from the output queue when no output is either present or pending, or
- data in the output queue has been lost.

**Device Specific Errors (-399 to -300, 201 to 703, and 800 to 810)** indicate that a device operation did not properly complete, possibly due to an abnormal hardware or firmware condition. These codes are also used for self-test response errors. Errors in this class set the device-specific error bit (bit 3) in the event status register (IEEE 488.2, section 11.5.1).

The <error\_message> string for a *positive* error is not defined by SCPI. A positive error indicates that the instrument detected an error within the GPIB system, within the instrument's firmware or hardware, during the transfer of block data, or during calibration.

**Execution Errors (-299 to -200)** indicate that an error has been detected by the instrument's execution control block. Errors in this class set the execution error bit (bit 4) in the event status register (IEEE 488.2, section 11.5.1). In this case:

- Either a <PROGRAM DATA> element following a header was evaluated by the device as outside of its legal input range or is otherwise inconsistent with the device's capabilities, or
- a valid program message could not be properly executed due to some device condition.

Execution errors are reported *after* rounding and expression evaluation operations are completed. Rounding a numeric data element, for example, is not reported as an execution error.

**Command Errors (-199 to -100)** indicate that the instrument's parser detected an IEEE 488.2 syntax error. Errors in this class set the command error bit (bit 5) in the event status register (IEEE 488.2, section 11.5.1). In this case:

- Either an IEEE 488.2 syntax error has been detected by the parser (a control-to-device message was received that is in violation of the IEEE 488.2 standard. Possible violations include a data element that violates device listening formats or whose type is unacceptable to the device.), or
- an unrecognized header was received. These include incorrect device-specific headers and incorrect or unimplemented IEEE 488.2 common commands.

### Error Message File

A complete list of error messages is provided on the CDROM supplied with the instrument. In the error message file, an explanation is generally included with each error to further clarify its meaning. The error messages are listed numerically. In cases where there are multiple listings for the same error number, the messages are in alphabetical order.

## Front Panel Tests

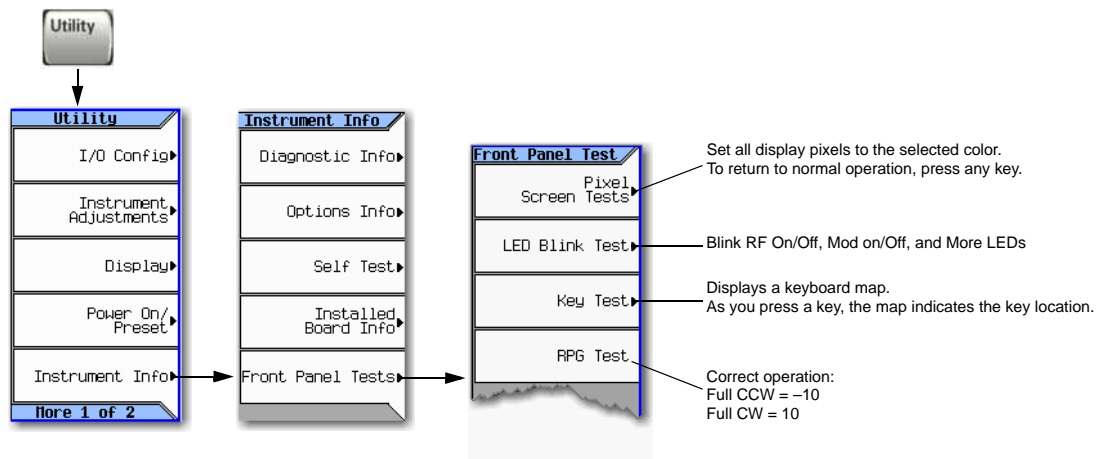

For details on each key, use key help as described on [page 42](#).

## Self Test Overview

The self test is a series of internal tests that checks different signal generator functions. The self test, is also available by via the remote web interface. For more information on the Web-Enabled MXG, refer to the *Programming Guide*.

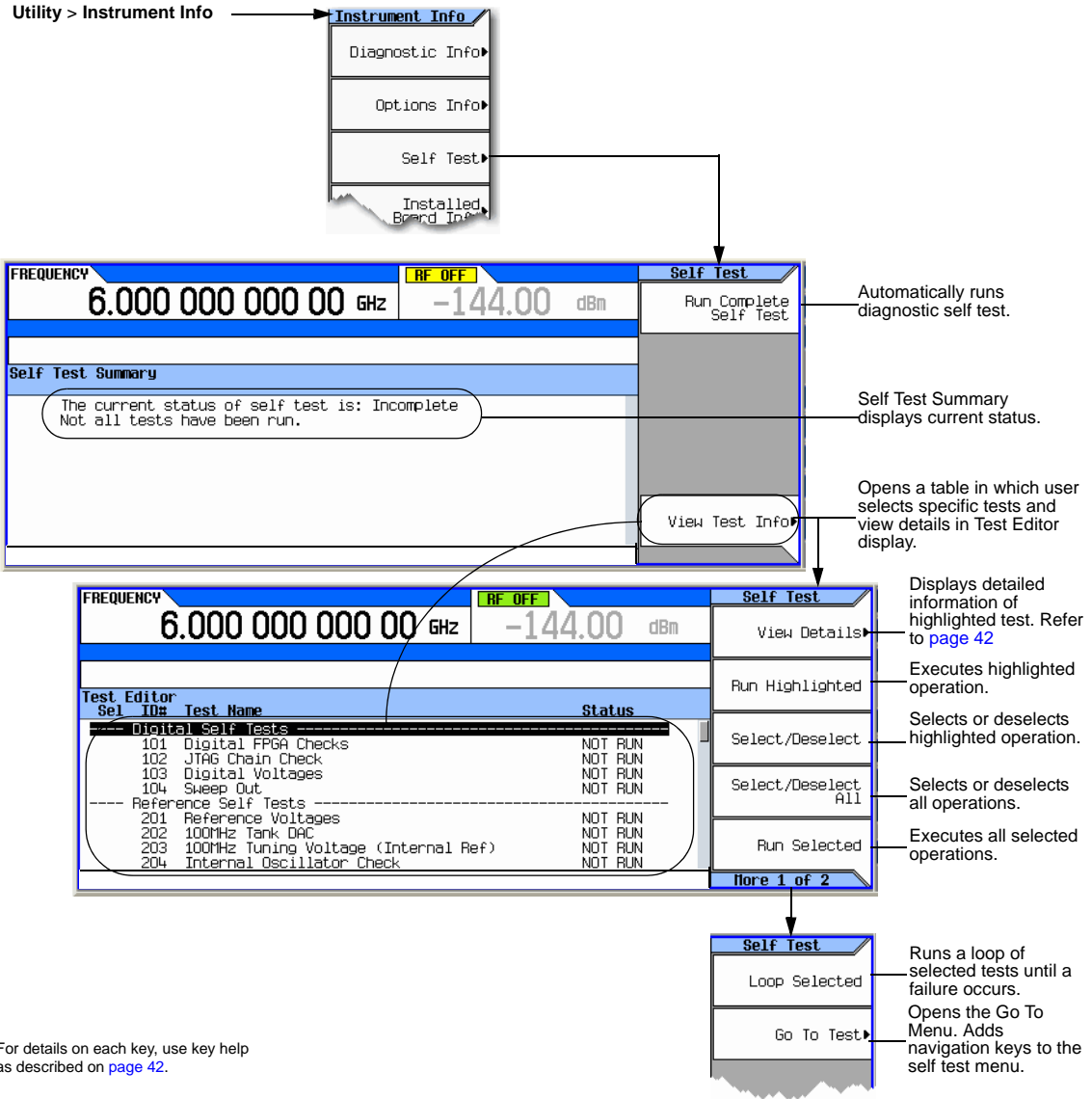

For details on each key, use key help as described on [page 42](#).

---

**NOTE** N5183A MXG with non 1E1 Option (no attenuator), a warning message will be displayed on the Self Test Summary window as shown below.

---

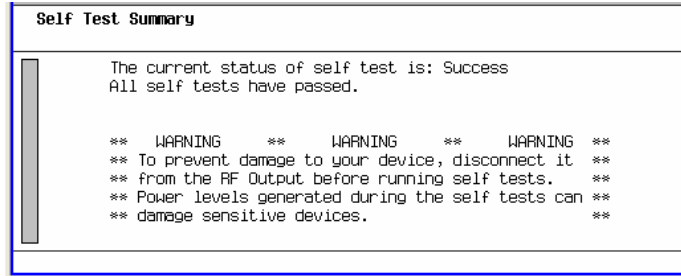

For instruments with attenuators the attenuators are auto set to maximum value before self-test executes and resets to nominal at conclusion.

## Licenses

---

**NOTE** If your instrument has A.01.50 firmware loaded, two years after purchase, your MXG can display the following time-based error message: "AUS license expires in xxd days. Contact Agilent Technologies to renew." The error message will repeat three times over 90 days (e.g. first at 90-60 days remaining, second at 59-30 days remaining, and the last at 30-0 days remaining days).

This message can be ignored. This error does not indicate a performance problem with your MXG. Pressing any softkey will clear the message and the instrument can be used normally.

Downloading a newer version of firmware will prevent further AUS license-related error messages being displayed.

---

### A Time-Based License Quits Working

- The instrument's time or date may have been reset forward causing the time-based license to expire.
- The instrument's time or date may have been reset backward more than approximately 25 hours, causing the instrument to ignore time-based licenses.

See [page 28](#) for details and cautions on setting time and date.

### Cannot Load a Time-Based License

The instrument's time or date may have been reset backward more than approximately 25 hours, causing the instrument to ignore time-based licenses.

See [page 28](#) for details and cautions on setting time and date.

### Contacting Agilent Technologies

- assistance with test and measurements needs, and information on finding a local Agilent office: <http://www.agilent.com/find/assist>
- accessories or documentation: <http://www.agilent.com/find/mxg>
- new firmware releases: <http://www.agilent.com/find/upgradeassistant>.

If you do not have access to the Internet, please contact your field engineer.

---

**NOTE** In any correspondence or telephone conversation, refer to the signal generator by its model number and full serial number. With this information, the Agilent representative can determine whether your unit is still within its warranty period.

---

### Returning a Signal Generator to Agilent

Use the following steps to return a signal generator to Agilent Technologies for servicing:

1. Gather as much information as possible regarding the signal generator's problem.
2. Call the phone number listed on the Internet (<http://www.agilent.com/find/assist>) that is specific

to your geographic location. If you do not have access to the Internet, contact your Agilent field engineer.

After sharing information regarding the signal generator and its condition, you will receive information regarding where to ship your signal generator for repair.

3. Ship the signal generator in the original factory packaging materials, if available, or use similar packaging to properly protect the signal generator.





## Glossary

### A

**Active Entry** The currently selected, and therefore editable, entry or parameter

**ARB** Arbitrary waveform generator

**AWG** Arbitrary waveform generator. Additive white Gaussian noise

### B

**BBG Media** Baseband generator media. Volatile memory, where waveform files are played or edited.

**BNC Connector** Bayonet Neill-Concelman connector. A type of RF connector used to terminate coaxial cable.

### C

**CCW** Counterclockwise

**C/N** Carrier-to-noise ratio

**CW** Continuous wave. Clockwise

### D

**DHCP** Dynamic host communication protocol

**Dwell Time** In a step sweep (see [page 50](#)), the time that the signal is settled and you can make a measurement before the sweep moves to the next point.

### E

**EVM** Error vector magnitude; the magnitude of the vector difference at a given instant between the ideal reference signal and the measured signal.

### F

**Filter factor Alpha** The filter's alpha coefficient. It is only valid for root nyquist and nyquist filters.

**Filter Factor BbT** The filter's bandwidth-bit-time (BbT). It is only valid for a Gaussian filter (similar to alpha). BbT is defined by the GSM standard as 0.3 and by the DECT standard as 0.5.

### G

**Gaussian filter** The Gaussian filter does not have a zero Inter-Symbol Interference (ISI). Wireless system architects must decide just how much of the ISI can be tolerated in a system and combine that with noise and interference. The Gaussian filter is gaussian shaped in both the time and frequency domains, and it does not ring like the root nyquist filters do. The effects of this filter in the time domain are relatively short and each symbol interacts significantly (or causes ISI) with only the preceding and succeeding symbols. This reduces the tendency for particular sequences of symbols to interact, which makes amplifiers easier to build and more efficient.

**GPIO** General purpose interface bus. An 8-bit parallel bus common on test equipment.

### H

**Hardkey** A labeled button on the instrument.

### I

**IF** Intermediate frequency

**Int Media** Internal media. Non-volatile signal generator memory, where waveform files are

stored.

**IP** Internet protocol. The network layer for the TCP/IP protocol suite widely used on Ethernet networks.

## L

**LAN** Local area network

**LO** Local oscillator

**LXI** LAN eXtension for Instrumentation. An instrumentation platform based on industry standard Ethernet technology designed to provide modularity, flexibility, and performance to small- and medium-sized systems. See also <http://www.lxistandard.org>

## M

**Modulation Format** Custom modulation, Two Tone, or Multitone.

**Modulation Mode** Dual ARB, Custom modulation, Two Tone, or Multitone.

**Modulation Standard** Refers to a Cellular standard format (i.e. NADC, PDC, PHS, etc.).

**Modulation Type** Refers to the various I/Q constellation types (i.e. PSK, MSK, FSK, C4FM, etc.).

## N

**Non-volatile** That which survives a power cycle (such as files stored in USB media).

**Nyquist filter** Also referred to as a cosine filter. These filters have the property that their impulse response rings at the symbol rate. Adjacent symbols do not interfere with each other at the symbol times because the response

equals zero at all symbol times except the center (desired) one.

## P

**Persistent** That which is unaffected by preset, user preset, or power cycle.

**Point-to-point Time** In a step sweep (page 50), the sum of the dwell time, processing time, switching time, and settling time.

## R

**Rectangular filter** Also referred to as a ideal low pass filter. These filters have very steep cut-off characteristics. The pass band is set to equal the symbol rate of the signal. Due to a finite number of coefficients, the filter has a predefined length and is not truly “ideal”. The resulting ripple in the cut-off band is effectively minimized with a Hamming window. This filter is recommended for achieving optimal ACP. A symbol length of 32 or greater is recommended for this filter.

**Root Nyquist filter** Also referred to as a Root cosine filter. These filters have the property that their impulse response rings at the symbol rate. Adjacent symbols do not interfere with each other at the symbol times because the response equals zero at all symbol times except the center (desired) one. Root nyquist filters heavily filter the signal without blurring the symbols together at the symbol times. This is important for transmitting information without errors caused by ISI. Note that ISI does exist at all times except the symbol (decision) times. A cascade of two of these filters has the transfer function of a Nyquist filter. One is in the transmitter, the other in the receiver, so that the system taken as a whole has the zero-ISI properties of an ISI filter.

**RMS** Root mean square. A time-varying signal's effective value (the equivalent DC voltage required to generate the equivalent heat across a given resistor). For a sinewave,  $RMS = 0.707 \times$

peak value.

## **S**

**Softkey** A button located along the instrument's display that performs whatever function is shown next to it on that display.

## **T**

**TCP** Transmission control protocol. The most common transport layer protocol used on Ethernet and the Internet.

**Terminator** A unit indicator (such as Hz or dBm) that completes an entry. For example, for the entry 100 Hz, *Hz* is the terminator.

**Type-N Connector** Threaded RF connector used to join coaxial cables.

## **U**

**USB** Universal serial bus. See also <http://www.usb.org>

**User FIR** Selects a user-defined set of coefficient values. Each line in the FIR values table contains one coefficient value. The number of coefficient values listed must be a multiple of the selected oversampling ratio. Each coefficient applies to both I and Q components.

## **V**

**Volatile** That which does not survive a power cycle (such as files stored in BBG media).



**Symbols**

, 209

ΦM

- annunciator, 11, 13
- dc offset, removing, 77
- hardkey, 75
- softkeys, 75, 77

# points softkey, 51

# Skipped Points softkey, 162

**Numerics**

10 MHz OUT connector, 17, 23

100Base-T LAN cable, 31

128 QAM softkey, 269

1410, application note, 298

16-Lvl FSK softkey, 269

16QAM softkey, 269

256 QAM softkey, 269

2-Lvl FSK softkey, 269

32QAM softkey, 269

430, option

- multitone mode, 304

- two-tone, 298

- two-tone mode, 298

4-Lvl FSK softkey, 269

4QAM softkey, 269

5-Pack

- history, waveform files, 246

- licensing, 239

- licensing, installing, 239

- licensing, understanding, 239

- licensing, waveform file, 240

- status messages, 242

- warning messages, 250

628, error, 196

64QAM softkey, 269

651/652/654, option

- description, 4

- multitone mode, 304

- two-tone mode, 298

670/671/672, option

- description, 4

8557D GPIB only softkey, 33, 35

8648A/B/C/D GPIB only softkey, 33, 35

8656B,8657A/B GPIB only softkey, 33, 35

8-Lvl FSK softkey, 269

**A**

AC power receptacle, 15, 21

ACP, 266

Activate Secure Display softkey, 26

active

- entry, 331

- entry area, 11

Active High softkey, 175

Active Low softkey, 175

Add Comment To softkey, 69

additive white Gaussian noise. *See* AWGN

address, GPIB, 30

Adjust Phase softkey, 45, 47

Adjustable doublet softkey, 128

adjustments

- I/Q, 138, 203

- quadrature, 203

- real-time phase noise, 263

advance, segment, 177

Advanced Settings softkey, 31

Aeroflex softkey, 33, 35

Agilent MXG

- modes of operation, 4

Agilent sales and service offices, 328

ALC

- hold, 158, 159

- OFF annunciator, 11, 13

- off mode, 110

- softkeys, 45, 47, 162

alc

- setting, 47

ALC Input

- connector, 24

All softkey, 63

Alpha, 331

AM

- annunciator, 11, 13

- connector, 16, 22

- external source, 77

- hardkey, 75

- softkeys, 75

- wideband, 77

amplitude

- display area, 12

- hardkey, 45, 47

- modulation, 75

- offset, 113

- reference, 114

- setting, 45, 47

- troubleshooting sweep, 322

AMPTD hardkey, 45, 47

analog modulation, 4, 75

angle, quadrature, 138

annunciators, 11, 13

APCO 25 w/C4FM softkey, 268

APCO 25 w/CQPSK softkey, 268

apodization settings, FIR filter, 216, 287

application notes

- 1410, 298

Apply To Waveform softkey, 162

ARB

- definition, 331

- player, dual, 142

---

# Index

- softkeys, [142, 173, 252, 253, 254, 255, 260](#)
- waveform clipping, [181](#)
- arb, [266](#)
- Arb Custom
  - FIR filters, [281](#)
  - FIR table editor, [286](#)
- Arb Segment softkey, [68](#)
- Arb Sequence softkey, [68](#)
- arb setup
  - softkey, [219](#)
- ARMED annunciator, [11, 13](#)
- arrow keys, [43](#)
- ASK Depth softkey, [269](#)
- ASK softkey, [269](#)
- ATTEN HOLD annunciator, [11, 13](#)
- Atten/ALC Control softkey, [45, 47](#)
- Auto softkeys
  - (DHCP/Auto-IP), [31](#)
  - Auto, [110](#)
  - Recall, [126](#)
- AUTOGEN\_WAVEFORM file, [266](#)
- auto-IP, [31](#)
- Auto-IP softkey, [31](#)
- Automatically Use USB Media If Present softkey, [63](#)
- AUX I/O connector, [20](#)
- Auxiliary Software Options softkey, [38](#)
- AWGN
  - adding, [251](#)
  - annunciator, [11, 13](#)
  - definition, [331](#)
  - dual ARB player, [251](#)
  - softkeys, [257](#)
- AWGN softkeys, [252, 253, 254, 255](#)
  
- B**
- backspace hardkey, [43](#)
- Bandwidth softkey, [257](#)
- baseband, [20](#)
  - aligning signals at, [158](#)
  - clipping, [181](#)
  - frequency offset
    - softkey location, [196](#)
  - frequency offset, setting, [196](#)
  - I/Q output connectors, [18](#)
  - memory, [142, 309](#)
  - noise, [251](#)
  - noise annunciator, [11, 13](#)
  - quadrature adjustment, [203](#)
  - real time I/Q AWGN, [252, 253, 254, 255, 257](#)
  - softkey, [196](#)
  - summing signals, [202](#)
  - waveforms convert to analog, [191](#)
- baseband frequency offset
  - DAC over range & scaling, [198](#)
- softkey, [196](#)
- baseband generator, [266](#)
  - custom arb mode, [4](#)
  - dual arb mode, [5](#)
  - multiple BBG synchronization, [220](#)
  - multitone mode, [4, 5, 304](#)
  - two-tone mode, [298](#)
- BB GEN, [202](#)
- BBG
  - media, [142, 144](#)
  - media (definition), [331](#)
  - Memory softkey, [68](#)
  - Memory to USB softkey, [68](#)
  - routing, [202](#)
  - Segments softkey, [63, 151](#)
- BBG sync, [220](#)
  - configure setup, [224](#)
  - equipment setup, [224](#)
  - resynchronization, [226](#)
  - system, [223](#)
  - system delay, [223](#)
  - trigger setup, [223](#)
- BbT, [331](#)
- Binary softkey, [63](#)
- bits per symbol, equation, [291](#)
- Bk Sp hardkey, [43](#)
- Bluetooth softkey, [268, 269](#)
- BNC, [331](#)
- bootrom memory, [309](#)
- Bright Color softkey, [26](#)
- brightness adjustment, [26](#)
- Brightness softkey, [26](#)
- Buffered Trig softkey, [175](#)
- Build New Waveform Sequence softkey, [147, 171](#)
- Burst Envelope softkey, [200](#)
- Bus softkey, [49](#)
  
- C**
- C/N, [331](#)
- C4FM softkey, [269](#)
- cables
  - crossover, [31](#)
  - multi-BBG sync, [223](#)
- cables, 100Base-T LAN, [31](#)
- Calculate softkey, [151](#)
- calibration
  - data, [309](#)
  - data memory, [311](#)
  - I/Q, [205](#)
  - softkey, [205](#)
- Calibration Type softkey, [205](#)
- Cancel hardkey, [6](#)
- carrier
  - bandwidth, [251](#)

- configuring, 46
  - feedthrough, 138
  - modulating, 60
  - softkeys, 252, 253, 254, 255
  - to noise ratio, 251
  - Carrier Bandwidth softkey, 252, 253, 254, 255
  - carrier feedthrough, minimizing, 301
  - Carrier Softkey, 252, 253, 254, 255
  - Carrier to Noise softkey, 252, 253
  - Carrier+Noise softkey, 252, 254, 255
  - Catalog Type softkey, 63, 64, 68, 151
  - catalog, state files, 72
  - ccw, 331
  - CDPD softkey, 268, 269
  - ceiling function, bits per symbol, 291
  - Channel Band softkey, 45, 47
  - Channel Number softkey, 45, 47
  - circular clipping, 185, 188
  - classified. *See* security
  - Clear softkeys
    - Error Queue(s), 74
    - Header, 151
    - Text, 43
  - clipping
    - circular, 185, 188
    - rectangular, 186, 189
    - softkeys, 181
  - clock, sample rate, 20
  - coefficient values, entering, 210, 282
  - color palette, display, 26
  - comments, adding & editing (instrument state), 70
  - component test, 266
  - Config Type softkey, 31
  - Configure softkeys
    - Cal Array, 89
    - List Sweep, 49, 56
    - Step Array, 89
    - Step Sweep, 49, 51
  - Confirm Load From File softkey, 67
  - Connection Monitoring softkey, 31
  - Connection Type softkeys
    - Sockets, 92
    - USB, 92
    - VXI-11, 92
  - connectors
    - external triggering source, 178, 180
    - front panel, 5, 9
    - rear panel
      - n5161a, 15
      - n5162a, 15
      - n5181a, 15
      - n5182a, 15
      - n5183a, 21
    - routing signals, 50
  - Continuous softkey, 175
  - continuous step sweep example, 59
  - continuous wave
    - description, 4
  - continuous wave output, 46
  - contrast adjustment, 26
  - Contrast softkey, 26
  - Copy & softkeys
    - Play Sequence, 67
    - Play Waveform, 67
    - Select User Flatness, 67
    - Select User Flatness Corrections, 67
  - Copy softkeys
    - All Files, 68
    - File, 63
    - File to Instrument, 63, 68
    - File to USB, 68
  - correction array (user flatness), 94
    - viewing, 95
    - See also* user flatness correction
  - corrections, internal channel, 97, 99
  - cosine filter. *See* nyquist filter
  - Create Directory softkey, 63, 68
  - crossover cable, 31
  - custom
    - multicarrier TDMA waveforms
      - creating, 278
    - TDMA digital modulation, 271
  - Custom ARB softkeys, 267
  - custom arb waveform generator, 4
  - custom mode, 266
  - custom modulation
    - adding to a waveform, 271
    - waveform, adding to, 271
  - cw, 331
  - CW (no modulation) softkey, 56
  - CW mode
    - description, 4
- ## D
- DAC over range error, 191, 196
  - DAC over range protection
    - baseband frequency offset, 198
    - phase noise, 264
  - Dark Color softkey, 26
  - data
    - calibration, 309
    - entry softkeys, 43
    - erasing, 312
    - files, 62–69
    - removing, 312
    - serial, synchronizing, 20
    - storage
      - comments, adding and editing, 70
      - troubleshooting, 323
      - type, 73

---

# Index

- using, [62](#)
  - date, setting, [28](#)
  - dc offset, [138](#)
  - dc offset, removing, [77](#)
  - DCFM $\Phi$ /DCfM Cal softkey, [75](#)
  - DECT softkey, [268](#)
  - Default Gateway softkey, [31](#)
  - default settings
    - restoring, [27](#), [31](#), [205](#)
    - system, restoring, [42](#)
  - Default softkey, [268](#)
  - delay
    - I/Q, [203](#)
    - multiple BBG sync, [223](#)
  - Delete softkeys
    - All Regs in Seq, [69](#)
    - All Segments On Int Media, [144](#)
    - All Segments On USB Media, [144](#)
    - All Sequence Files, [63](#)
    - All Sequences, [69](#), [126](#)
    - All Waveforms, [147](#)
    - All Waveforms softkey, [171](#)
    - File, [63](#)
    - File or Directory, [63](#), [65](#), [68](#), [73](#)
    - Item, [56](#)
    - Row, [56](#)
    - Selected Waveform, [147](#), [171](#)
    - Seq Reg, [69](#)
    - Waveform Sequence, [171](#)
  - description & plots, phase noise, [261](#)
  - DETHTR annunciator, [12](#), [13](#)
  - Device softkey, [45](#), [47](#)
  - DHCP, [31](#), [331](#)
  - DHCP softkey, [31](#)
  - Diff Mode softkeys, [203](#)
  - differential encoding, [289](#)
  - differential encoding, bits per symbol, [291](#)
  - differential state map, bits per symbol, [291](#)
  - DIGBUS annunciator, [12](#), [14](#)
  - digital bus, [19](#)
  - digital modulation
    - formats, [4](#)
    - IQ map, QAM, [290](#)
    - multitone, [304–307](#)
    - TDMA, [271](#)
    - two tone, [298–303](#)
  - digital modulation type
    - modifying, [274](#)
  - digital operation, [141](#), [231](#), [239](#)
  - digital signal to analog waveform, [191](#)
  - display
    - blanking, [315](#)
    - error message area, [13](#)
    - memory, [309](#)
    - overview, [5](#), [13](#)
    - overview, N5161A/62A, [13](#)
    - overview, N5181A/82A/83A, [11](#)
    - secure, [315](#)
    - settings, [26](#)
    - softkey labels, [13](#)
    - softkeys, [25](#), [43](#), [162](#)
    - tests, [325](#)
    - text area, [13](#)
    - troubleshooting, [318](#)
  - Display softkeys
    - Case, [43](#)
    - display, [25](#)
    - Waveform And Markers, [162](#)
  - Displayed Case softkeys, [43](#)
  - distortion, troubleshooting, [319](#)
  - DNS Server Override softkey, [31](#)
  - DNS Server softkey, [31](#)
  - documentation, [xiii](#)
  - Domain Name softkey, [31](#)
  - doublet
    - adjustable, [130](#)
    - softkeys, [128](#)
    - trigger, [130](#)
  - Dual ARB
    - FIR table editor, [210](#), [215](#)
    - real-time modulation, [219](#)
    - user-defined FIR, [210](#)
  - dual ARB
    - multi-BBG sync, [220](#)
    - player, [142](#)
    - real-time noise, [251](#)
    - softkeys, [143](#), [252](#), [253](#), [254](#), [255](#), [260](#)
  - dual arb, [266](#)
  - dual ARB player, [5](#)
  - Dual ARB Real-Time
    - filters, [209](#)
  - dual arbitrary waveform generator, [5](#)
  - dual display, power meter, [80](#)
  - dwll time, [56](#), [331](#)
  - Dwell Type softkey, [56](#)
  - dwll, troubleshooting, [322](#)
  - Dynamic DNS Naming softkey, [31](#)
  - Dynamic Hostname Services softkey, [31](#)
- ## E
- E4428C, E4438C softkey, [33](#), [35](#)
  - E442xB, E443xB softkey, [33](#), [35](#)
  - E8241A, E8244A, E8251A, E8254A softkey, [33](#), [35](#)
  - E8247C, E8257C, E8267C softkey, [33](#), [35](#)
  - E8257D, E8267D softkey, [33](#), [35](#)
  - EDGE
    - custom digital modulation, predefined, [271](#)
  - EDGE softkey, [268](#)
  - Edit softkeys



- Description, 151
- Noise RMS Override, 151
- Repetitions, 171
- RMS, 151
- Selected Waveform Sequence, 147, 171
- Editing Keys softkey, 43
- Editing Mode softkey, 43
- EEPROM, 309
- Enable/Disable Markers softkey, 147, 171
- Enter Directory softkey, 67
- entry, active, 331
- equalization
  - filter, 207
  - filter, user, 207
- equipment setup, 224
- equipment, user flatness correction, 90, 91
- ERR annunciator, 12, 14
- Error hardkey, 74
- error messages, 74
  - DAC over range, 191, 196
  - display area, 13
  - file, 324
  - message format, 74
  - types, 324
- Esc hardkey, 6
- EVENT
  - connector, AUX I/O, 20
  - connector, BNC, 19, 157
  - output jitter, 173
  - outputs, 157
- EVM, 331
- EVM error, 138
- example
  - 5-Pack License, adding, 243
  - 5-Pack License, history, 248
  - Waveform 5-Pack License, adding, 243
  - Waveform 5-Pack License, history, 248
  - Waveform license, Opt 25x
    - adding a waveform, 236
    - locking a slot, 236
- examples
  - FIR filters
    - creating, 210, 281
    - modifying, 215, 286
- Execute Cal softkey, 205
- EXT CLOCK connector, 18
- EXT REF annunciator, 11, 12, 13, 14
- Ext softkeys
  - Delay, 176
  - Delay Time, 176
  - Ext, 49
  - I/Q Output, 200, 201
  - Pulse, 128
  - Source, 176
- extension, file, 67

- external
  - I and Q signals, 202
  - media, 73, 323
  - modulation source, 77
  - reference oscillator, using, 46
  - trigger source, 178, 180
  - triggering, 180
- external leveling, 102–109
  - softkeys, 102
- external leveling, configuring, 106
- External softkeys
  - External, 200
  - Input, 203
  - Input I Offset, 138
  - Input Q Offset, 138
  - Output, 203

## F

- factory defaults, restoring, 27, 31, 205
- features, 2
- feedthrough, 138
- feedthrough, carrier, minimizing, 301
- File hardkey, 63, 72
- file headers
  - creating, 151
  - editing, 153
  - example, 154
  - viewing a different file, 155
- files
  - catalog. *See* data storage
  - extensions, 67
  - working with, 62
- filter
  - equalization, 207
  - real-time modulation
    - softkey location, 219
    - user, equalization, 207
- filter, interpolator, 191
- filters
  - finite impulse response, 209, 281
  - FIR, 209, 281
  - gaussian, loading default, 216, 287
  - nyquist, selecting, 275
- filters Dual ARB, 209
- finite impulse response filters
  - using, 209, 281
- FIR filter
  - apodization settings, 216, 287
  - Hamming, 216, 287
  - Hann, 216, 287
  - Kaiser, 216, 287
  - window settings, 216, 287
- FIR filters
  - Arb Custom, 281
  - creating, 210, 281

---

# Index

- modifying, [215, 286](#)
  - storing, [214, 285](#)
  - using, [209, 281](#)
  - FIR table editor
    - accessing, [210, 281](#)
    - Arb Custom, [286](#)
    - coefficients, duplicating, [212, 284](#)
    - coefficients, entering values, [210, 282](#)
    - coefficients, modifying, [217, 288](#)
    - Dual ARB, [210, 215](#)
    - files, loading, [216, 287](#)
    - filters
      - creating, [210, 281](#)
      - modifying, [215, 286](#)
      - storing, [214, 218, 285, 289](#)
    - oversample ratio, setting, [213, 284](#)
  - firmware
    - memory, [309](#)
    - upgrading, [29, 328](#)
  - First Mkr Point softkey, [162](#)
  - First Sample Point softkey, [162](#)
  - Fixed softkey, [110](#)
  - flash memory, [309](#)
  - flatness correction. *See* user flatness correction
  - Flatness softkey, [89](#)
  - FM
    - annunciator, [12, 14](#)
    - connector, [16, 22](#)
    - dc offset, removing, [77](#)
    - external source, [77](#)
    - hardkey, [75](#)
    - softkeys, [75](#)
  - Free Run softkey, [49, 117, 175](#)
  - Free-Run softkey, [128](#)
  - Freq Dev softkey, [269](#)
  - FREQ hardkey, [45, 47](#)
  - Freq softkeys, [89](#)
  - frequency
    - display area, [11](#)
    - hardkey, [7, 8, 45, 47](#)
    - modulation, [75](#)
    - multiplier, [115](#)
    - offset, [113](#)
    - offset, baseband, [196](#)
    - offset, softkeys, [196](#)
    - reference, [114](#)
    - setting, [45, 47](#)
    - softkeys, [45, 47](#)
    - step sweep, [52](#)
  - frequency units, [45](#)
  - front panel
    - disabling keys, [315](#)
    - display, [13](#)
    - display, N5161A, [13](#)
    - display, N5181A, [11](#)
    - display, N5182A, [11](#)
    - display, N5183A, [11](#)
    - I/Q inputs, using, [139](#)
    - knob resolution, [28](#)
    - overview, [5, 9](#)
    - tests, [325](#)
  - FSK softkey, [269](#)
  - FTP Server softkey, [32](#)
  - fundamental operation *See* basic operation
- ## G
- Gated softkey, [128, 175](#)
  - gated triggering, [176, 178](#)
  - Gaussian
    - definition, [331](#)
    - gaussian filter, loading default, [216, 287](#)
  - Gaussian. *See* AWGN
  - glossary, [331](#)
  - Go To Default Path softkey, [63, 65, 73](#)
  - Goto Row softkey, [56, 63](#)
  - GPIB
    - connector, [17, 23](#)
    - definition, [331](#)
    - setup, [30](#)
    - softkeys
      - Address, [30](#)
      - Setup, [30](#)
  - green LED, [8, 10](#)
  - GSM softkey, [268](#)
  - guides, content of, [xiii](#)
- ## H
- hardkeys
    - definition, [331](#)
    - help on, [42](#)
    - overview, [5, 9](#)
    - See also* specific key
  - header utilities softkeys, [151](#)
  - Help hardkey, [7, 42](#)
  - Hostname softkey, [31](#)
  - hostname, setting, [31](#)
  - HP 3300A, emulating, [126](#)
- ## I
- I connector, [7](#)
  - I Offset softkey, [203](#)
  - I OUT connector, [18](#)
  - I/O Config softkey, [25](#)
  - I/Q
    - adjustments, [138, 203](#)
    - front panel inputs, using, [139, 202](#)
    - Int Equalization Filter softkeys location, [208](#)
    - modulation, [138, 200](#)
    - optimizing, [201](#)
    - rear panel outputs, [18](#)

- rear panel outputs, using, 201
- signal path, optimizing, 201
- signal, aligning, 158
- softkey, 208
- softkeys, 138, 200–206
- waveform, clipping, 181
- ideal low-pass filter. *See* rectangular filter
- IF, 331
- images, 138
- impairments
  - I/Q adjustments, 138
- impairments, real-time
  - phase noise, 259
- Import Waveform softkey, 171
- Incr Set hardkey, 8
- information, removing from memory, 312
- Insert softkeys
  - Insert, 147
  - Item, 56
  - Row, 56
  - Waveform, 147
  - Waveform Sequence Contents, 147
- Install Assembly softkey, 39
- Install licenses softkey, 67
- installation guide content, xiii
- instrument
  - 8757D Scalar Network Analyzer, 54
  - firmware, upgrading, 29
  - scalar network analyzer, 54
  - softkeys
    - Adjustments, 25
    - Info, 25
    - Options, 38
  - state
    - associating with waveform, 70
    - files, 69, 72
    - register. *See* data storage
    - softkey, 68
- Int Equalization Filter
  - softkeys, 208
- int media, 331
- Int Phase Polarity softkey, 200
- interface
  - GPIO, 30
  - LAN, 31
- internal
  - reference oscillator, using, 29
- Internal Baseband Adjustments softkey, 203
- internal media, 73
- Internal Storage to USB softkey, 68
- Internal/USB Storage Selection softkey, 63
- interpolator filter, 191
- IP
  - Address softkey, 31
  - address, setting, 31
  - auto, 31
  - definition, 332
- IQ map, QAM modulation, 290
- J**
- jitter on EVENT output, 173
- K**
- keyboard, using, 126
- keys
  - disabling, 315
  - front panel, 5, 9
  - help on, 42
  - numeric, 6
  - test, 325
  - See also* specific key
- knob, 8, 28, 43
- L**
- L annunciator, 12, 14
- LAN
  - connector, 17, 23
  - definition, 332
  - Services Setup softkey, 30
  - setup, 31
  - Setup softkey, 30
- Last Mkr Point softkey, 162
- Last softkey, 27
- LCD display memory, 309
- LEDs, 8, 10
  - blink test, 325
  - front panel, 8, 10
  - modulation, 61
- leveling
  - external, 102–109
  - turn off ALC, 110
- licenses
  - manager, 37
  - service software, 37
  - signal studio, 37
  - time-based, 28
  - troubleshooting, 328
  - viewing, 37
  - waveform, 37
- line power (green) LED, 8, 10
- linear sweep, 50
- list mode values, 57
- List softkey, 63
- list sweep
  - parameters, 57
  - status information, 57
  - troubleshooting, 322
  - using, 56
  - waveform, 58
- listener mode annunciator, 12, 14

---

# Index

LO, [332](#)

Load From Selected File softkey, [65](#), [67](#)

Load List softkey, [67](#)

Load softkeys

    All From Int Media, [144](#)

    All From USB Media, [144](#)

    Cal Array From Step Array, [89](#)

    From Selected File, [66](#), [67](#)

    Load/Store, [56](#), [66](#), [67](#)

    Segment From Int Media, [144](#)

    Segment From USB Media, [144](#)

    Store, [144](#)

    Sweep List, [67](#)

Load/Store softkey, [56](#), [65](#), [67](#)

Local hardkey, [6](#)

lock up, troubleshooting, [318](#)

logarithmic sweep, [50](#)

LVDS

    MXG, [2](#)

    PXB, [2](#)

LVDS compatibility with the PXB, [2](#)

LXI, [332](#)

    configuring the output events, [124](#)

    configuring the subsystem, [122](#)

    configuring the trigger input events, [123](#)

    getting started, [122](#)

    understanding the clocks, [120](#)

    using, [120](#)

LXI, option ALB, [120](#), [122](#)

## M

main memory, [309](#)

manual control, sweep, [60](#)

Manual softkey, [110](#)

Manual softkeys

    Config Settings, [31](#)

    Manual, [31](#)

    Mode, [49](#)

    Point, [49](#)

manuals, content of, [xiii](#)

Marker softkeys, [162](#)

markers

    frequency

        N5183A, [54](#)

        step sweep, [54](#)

markers, aligning signal, [158](#)

markers, waveform, [157](#)–[173](#)

media

    BBG, [331](#)

    erasing, [312](#)

    Flash Drive, [73](#)

    int, [331](#)

    storage, [73](#)

    types, [142](#), [309](#)

    USB, [73](#), [323](#)

memory

    erasing data from, [312](#)

    types, [309](#)

*See also* media

menu keys, [6](#)

messages, error, [324](#)

messages, warning

    5-Pack Licensing, [250](#)

    Opt 25x Licensing, [238](#)

    Waveform 5-Pack Licensing, [250](#)

mirror table, duplicating coefficients, [212](#), [284](#)

mixer, troubleshooting signal loss, [320](#)

Mod On/Off hardkey, [7](#), [60](#), [61](#)

Mod On/Off, Option UNT, [75](#)

Mod Type Softkeys, [269](#)

Mode hardkey, [143](#), [252](#), [253](#), [254](#), [255](#), [257](#), [260](#)

mode, modulation, [332](#)

modes of operation, [4](#)

Modulated softkey, [110](#)

modulation

    AM, [75](#)

    analog, [4](#)

    annunciators, [12](#), [14](#)

    carrier signal, [60](#)

    digital, [4](#)

    external source, using, [77](#)

    FM, [75](#)

    generating, [60](#)

    I/Q, [138](#), [200](#)

    phase, [75](#)

    pulse, [4](#), [127](#)

    real-time filter, softkeys, [219](#)

    simultaneous, [62](#)

    troubleshooting, [318](#)

Modulator Atten softkey, [257](#)

monochrome display, setting, [26](#)

Monochrome softkey, [26](#)

MSK softkey, [269](#)

MULT annunciator, [12](#), [14](#)

multi-BBG sync, [220](#)

    configure setup, [224](#)

    equipment setup, [224](#)

    resynchronize, [226](#)

    system delay, [223](#)

    system sync, [223](#)

    trigger setup, [223](#)

multicarrier setup

    APCO 25 w/C4FM, [278](#)

    APCO 25 w/CQPSK, [278](#)

    Bluetooth, [278](#)

    CDPD, [278](#)

    DECT, [278](#)

    Default, [278](#)

    EDGE, [278](#)

    GSM, [278](#)

- NADC, 278
  - PDC, 278
  - PHS, 278
  - PWT, 278
  - TETRA, 278
  - multicarrier setup softkeys, 278
  - multicarrier TDMA waveforms
    - creating, 278
  - multicarrier, Default softkey. *See* quick setup, Default softkey, settings
  - multiplier, using, 115
  - multitone, 266, 304–307
  - multitone mode, 4, 5
  - Multitone softkeys, 304
  - multitone waveform, setup, 297
  - MXG
    - LVDS, 2
  - MXG ATE N5161A/82A Front Panel Functions, 9, 10
- ## N
- NADC softkey, 268
  - Name And Store softkey, 171
  - Next REG softkey, 126
  - Next SEQ softkey, 126
  - No action softkey, 67
  - No Retrigger softkey, 175
  - noise, 251
  - noise bandwidth factor, 251
  - Noise Bandwidth softkey, 252
  - Noise Mux softkeys, 254, 255
  - Noise softkey, 252, 254, 255
  - non-volatile memory, 142
  - non-volatile, definition, 332
  - number keys, 43
  - numeric keypad, 6
  - nyquist filter
    - definition
  - nyquist filter, selecting, 275
- ## O
- OFFS annunciator, 12, 14
  - offset, 138
  - offsets
    - baseband frequency, 196
    - I/Q, 203
    - output, using, 113
  - on/off switch, 8, 10
  - operation
    - modes of, 4
  - operation, basic, 41
  - operation, remote, 30
  - optimization, I/Q, 138, 200
  - option
    - 430
      - multitone mode, 304
      - two tone mode, 298
      - two-tone mode, 298
  - Option 22x, 239
  - option ALB, LXI, 120, 122
  - Option U01, 97, 99
    - internal channel correction, 97, 99
  - Option UNT
    - Mod On/Off hardkey, 75
  - options
    - 651/652/654
      - description, 4
      - multitone mode, 304
      - two-tone mode, 298
    - 670/671/672, description, 4
    - enabling, 25, 37
    - resource, 3
    - UNT, 4
    - UNU, 4
    - UNW, 4
  - Options 221-229, 239
  - Options 250-259, 231
  - Options Info softkey, 38
  - oscillator, external reference, 46
  - oscillator, internal reference, 29
  - Output Blanking softkey, 45, 47
  - Output Mux softkeys, 252
  - output, swept, 48
  - over range error, DAC, 191, 198, 264
  - overshoot, 191
  - overview, signal generator, 1
- ## P
- Page Up hardkey, 6
  - parameters, saving a waveform's, 151
  - path delay, 138
  - PATT TRIG IN connector, 19
  - Patt Trig In softkeys, 176
  - PDC softkey, 268
  - peak-to-average power, reducing, 185
  - performance, optimizing, 79
  - persistent
    - memory, 311
  - persistent settings
    - definition, 332
    - resetting, 42
    - restoring defaults, 27
  - phase noise
    - adjustments, 263
    - DAC over range & scaling, 264
    - description & plots, 261
    - impairments, 259
    - softkeys, 260
  - Phase Ref Set softkey, 45, 47
  - phase skew, 138
  - PHS softkey, 268

---

# Index

- pixel test, [325](#)
- Plot CDDF softkey, [190](#)
- PM Config
  - Calibrate Sensor, [92](#)
  - Zero Sensor, [92](#)
- PM Config softkeys
  - Connection Type, [92](#)
  - PM VXI-11 Device Name, [28](#)
  - Power Meter IP Address, [92](#)
  - Power Meter IP Port, [92](#)
- Point Trigger softkey, [49](#)
- point-to-point time, [332](#)
- polarity, external trigger, [176](#)
- polarity, marker, setting, [170](#)
- power
  - meter, [88, 93](#)
  - on, settings, [27](#)
  - peak-to-average, reducing, [185](#)
  - receptacle, [15, 21](#)
  - search, [111](#)
  - search automatic, [113](#)
  - search settings, [113](#)
  - sensor, models, [90, 91](#)
  - setting, [45, 47](#)
  - softkeys, [25, 27, 110](#)
  - supply, troubleshooting, [318](#)
  - switch, [8, 10](#)
  - troubleshooting, [319](#)
  - user settable, maximum, [47](#)
- Power Control Mode softkeys, [253](#)
- power meter
  - configuration, [93](#)
    - U2000 Series, [93](#)
    - U2000A/O1A/O2A/O4A, [93](#)
  - dual display, [80](#)
- power meter configuration softkeys. *See* PM Config softkeys
- power meter softkeys. *See* PM Config softkeys
- Power Search Reference softkey, [110](#)
- Power Search References, [111](#)
- Power softkeys
  - On, [27](#)
  - On/Preset, [25](#)
  - Search, [110](#)
- power units, [45](#)
- preferences, setting, [25](#)
- preset
  - hardkey location, [7](#)
  - settings, [27](#)
  - troubleshooting, [323](#)
  - using, [42](#)
- Preset softkeys
  - Language, [27](#)
  - List, [56, 89](#)
  - Preset, [27](#)
  - Prev REG softkey, [126](#)
  - Prev SEQ softkey, [126](#)
  - Proceed With Reconfiguration softkey, [31, 32](#)
  - programming guide content, [xiii](#)
  - protection, DAC over range
    - baseband offset frequency, [198](#)
    - phase noise impairment, [264](#)
  - PSK softkey, [269](#)
  - pulse
    - annunciator, [12, 14](#)
    - characteristics, [129](#)
    - connector, [16, 22](#)
    - marker, viewing, [167](#)
    - modulation, [127](#)
    - narrow, [110](#)
    - sync signal, [50](#)
    - video signal, [50](#)
  - Pulse hardkey, [128](#)
  - pulse modulation, [4](#)
  - Pulse softkeys, [50, 128](#)
  - Pulse/RF Blank softkey, [162](#)
  - PWT softkey, [268](#)
  - PXB
    - LVDS compatibility, [2](#)
- Q**
  - Q connector, [8](#)
  - Q Offset softkey, [203](#)
  - QAM modulation IQ map, [290](#)
  - QAM softkey, [269](#)
  - quadrature adjustment, [203](#)
  - quadrature angle, [138](#)
  - Quadrature Angle Adjustment softkey, [138, 203](#)
  - queue, error, [74](#)
  - quick setup
    - Default softkey
      - settings, [268](#)
  - Quick Setup Softkeys, [268](#)
- R**
  - R annunciator, [12, 14](#)
  - raised cosine filter. *See* nyquist filter
  - RAM, [309, 311](#)
  - real-time
    - AWGN
      - softkeys, [252, 253, 254, 255](#)
    - I/Q Baseband AWGN softkeys, [257](#)
    - modulation filter, [219](#)
    - modulation filter, setting, [219](#)
    - noise, [251](#)
    - phase noise, [259](#)
      - adjustments, [263](#)
      - DAC over range & scaling, [264](#)
      - description & plots, [261](#)
      - impairments, [259](#)

- softkeys, 260
  - real-time modulation
    - Dual ARB, 219
  - real-time modulation filter
    - softkey, 219
  - rear panel
    - I/Q outputs, 201
    - overview
      - n5161a, 15
      - n5162a, 15
      - n5181a, 15
      - n5182a, 15
      - n5183a, 21
  - Recall hardkey, 69
  - Recall keys
    - hardkey, 126
    - Instrument State, 63, 67
    - Reg, 126
    - State, 67
  - recall register, troubleshooting, 322
  - receiver test, 266
  - rectangular clipping, 186, 189
  - rectangular filter
    - definition, 332
  - REF annunciator, 12, 14
  - REF IN connector, 17, 22
  - Ref Oscillator Ext Bandwidth key, 46
  - Ref Oscillator Ext Freq key, 46
  - Ref Oscillator Source softkey, 45, 47
  - Ref Oscillator Tune key, 29
  - reference oscillator tune, internal, 29
  - reference oscillator, external, 46
  - reference, using, 114
  - references, content of, xiii
  - regrowth, spectral, 184
  - remote interface, emulate HP 3300A, 126
  - Remote Language softkey, 30, 33, 35
  - remote operation annunciator, 12, 14
  - remote operation preferences, 30
  - Remove Assembly softkey, 39
  - Rename File softkey, 63
  - Rename Segment softkey, 144
  - Reset & Run softkey, 175
  - Restart on Trig softkey, 175
  - Restore softkeys
    - LAN Settings to Default Values, 31
    - System Settings to Default Values, 27
  - resynchronize, multi-BBGs, 226
  - Return hardkey, 8
  - Reverse Power Protection softkey, 27
  - Revert to Default Cal Settings softkey, 205
  - RF
    - blanking
      - marker function, 168
      - settings, saving, 158
    - hardkey, 7
    - output
      - configuring, 46
      - connector, 7
      - leveling, external, 102–109
      - troubleshooting, 318
  - RF During Power Search softkey, 110
  - RF Output softkey, 200, 201
  - RFC NETBIOS Naming softkey, 31
  - ringing, 191
  - ripple, 191
  - RMS, 332
  - RMS softkey, 110
  - Rohde & Schwarz softkey, 33, 35
  - roort, 332
  - root cosine filter. *See* root nyquist filter
  - root mean square, 332
  - Root Nyquist Filter
    - definition, 332
  - root nyquist filter
    - definition, 332
  - rotary knob, 43
  - Route Connectors softkey, 49, 128
  - Route To softkeys, 50, 128
  - routing
    - I/Q, 138, 200
    - marker
      - ALC hold, 159
      - RF blanking, 168
      - saving settings, 158
  - RPG test, 325
  - runtime scaling, 193
- ## S
- S annunciator, 12, 14
  - sales, Agilent offices, 328
  - sample rate clock, 20
  - sample rate softkey, 173
  - Save hardkey, 69
  - SAVE Seq Reg softkey, 69
  - Save Setup To Header softkey, 151
  - Scale Waveform Data softkey, 190
  - scaling softkeys, 190
  - SCPI
    - enabling, 32
    - reference content, xiii
    - softkey, 33, 35
  - screen saver settings, 26
  - Screen Saver softkey, 26
  - search, power, 111
  - secure
    - display, 315
    - mode, 314
  - security, 309
  - Security softkey, 63

---

# Index

- Segment Advance softkey, 175
- segment advance triggering, 175
- segments
  - advance triggering, 177
  - file headers, 151
  - loading, 144
  - softkeys, 144
  - storing, loading, & playing, 144
- Select hardkey, 43
- Select Seq softkey, 126
- Select softkeys
  - Color Palette, 26
  - Different Header, 151, 155
  - Header, 151
  - Internal File(s) to Copy to USB, 68
  - Reg, 69
  - Seq, 69
  - Waveform, 56
- self test, 326
- Sequence softkey, 63, 151
- sequences
  - editing, 149
  - file headers, 151
  - marker control, 170
  - playing, 150
  - waveform, 147
- serial data, synchronizing, 20
- server, enabling, 32
- service
  - Agilent offices, 328
  - guide content, xiii
  - request annunciator, 12, 14
- Set Marker softkeys, 162
- settings, persistent, 332
- settings, phase noise, 263
- Show softkeys
  - Alpha Table, 43
  - Waveform Sequence, 147
  - Waveform Sequence Contents, 147, 171
- signal generator
  - modes, 4
- Signal Studio, 3
- signal studio licenses, 37
- sinewave, 332
- Single softkey, 175
- Single Sweep softkey, 49
- skew, I/Q, 203
- Sockets SCPI softkey, 32
- sockets, enabling, 32
- softkeys
  - definition of, 333
  - help on, 42
  - label area, 13
  - location, 5
  - See also* specific key
- source settled signal, 50
- Source Settled softkey, 50, 128
- Span softkey, 110
- Specify Default Storage Path for User Media softkey, 63
- spectral regrowth, 184
- spectrum analyzer, troubleshooting signal loss, 319
- square root raised cosine filter. *See* root nyquist filter
- Square softkey, 128
- standard, modulation, 332
- standby (yellow) LED, 8, 10
- State softkey, 63
- states, persistent, 332
- step array (user flatness), 94
  - See also* user flatness correction
- Step Dwell softkey, 51, 117
- Step Spacing softkey, 51
- step sweep
  - spacing, 50
  - troubleshooting, 322
  - using, 50
- Step/Knob Ratio softkey, 28
- Storage Type softkey, 65, 73
- Store Custom Dig Mod State softkey, 270
- Store To File softkey, 65, 66, 67
- Stored Segments softkey, 63, 151
- Subnet Mask softkey, 31
- Sum softkey, 200
- sweep
  - annunciator, 12, 14
  - hardkey, 49
  - linear, 50
  - list parameters, 57
  - list status information, 57
  - logarithmic, 50
  - manual control, 60
  - mode, 4
  - out connector, 15, 21, 50
  - out signal, 50
  - softkeys, 49–60, 128
  - step, 50
  - troubleshooting, 322
  - waveform, including, 58
- SWEEP hardkey, 49
- Sweep softkeys, 49–60, 68, 128
- swept output, 48
- switch, power, 8, 10
- SWMAN annunciator, 12, 14
- synchronize multi-BBGs, 220
  - configure setup, 224
  - equipment setup, 224
  - resynchronize, 226
  - system delay, 223
  - system sync, 223
  - trigger setup, 223
- system defaults, restoring, 27



**T**

T annunciator, [12, 14](#)  
 talker mode annunciator, [12, 14](#)  
 TCP, [333](#)  
 TCP Keep Alive softkeys, [31](#)  
 TDMA  
   custom digital modulation, predefined, [271](#)  
 TDMA digital modulation, [271](#)  
 terminator, [333](#)  
 test, self, [326](#)  
 test, self-web-enabled, [326](#)  
 tests, front panel, [325](#)  
 TETRA softkey, [268](#)  
 text area (on display), [13](#)  
 text entry softkeys, [144](#)  
 time, dwell, [331](#)  
 time, setting, [28](#)  
 time/date reference point, [28](#)  
 Time/Date softkey, [28](#)  
 time-based license, [28, 328](#)  
 Timer Trigger softkey, [49, 117](#)  
 Toggle softkeys, [171](#)  
 Total Noise softkey, [253](#)  
 Total softkey, [253](#)  
 Trig  
   in connector, [16, 22](#)  
   out connector, [16, 22, 50](#)  
   out signal, [50](#)  
 trigger  
   connectors, [16, 22](#)  
   hardkey, [6](#)  
   initiating, [6](#)  
   multiple BBG sync, [223](#)  
 Trigger setup softkeys, [119](#)  
 Trigger softkeys  
   & Run, [175](#)  
   Doublet, [128](#)  
   Key, [49](#)  
   Out Polarity, [49](#)  
   Source, [174](#)  
   Triggered, [128](#)  
   Type, [174](#)  
 Triggered softkey, [128](#)  
 triggering  
   gated, [176, 178](#)  
   multiple BBG sync, [223](#)  
   equipment setup, [224](#)  
   segment advance, [175](#)  
   softkeys, [174](#)  
   waveforms, [174](#)  
 troubleshooting, [317](#)  
 two tone, [266, 298–303](#)  
 two tone softkeys, [299](#)  
 two-tone softkeys, [299](#)  
 two-tone waveform, setup, [297](#)

type, modulation, [332](#)

**U**

UNLEVEL annunciator, [12, 14](#)  
 unlevelled operation, [110](#)  
 UNLOCK annunciator, [12, 14](#)  
 Unspecified softkey, [151](#)  
 UNT, option, [4](#)  
 UNU, option, [4](#)  
 UNW, option, [4](#)  
 Up Directory softkey, [63, 65, 68](#)  
 Update in Remote softkey, [26](#)  
 urls, [3, 29, 37, 328](#)  
 USB  
   connecting media, [73](#)  
   definition, [333](#)  
   device connector, [17, 23](#)  
   host connector, [5, 9](#)  
   keyboard, using, [126](#)  
   softkeys  
   File Manager, [63, 64](#)  
   Keyboard Control, [126](#)  
   to BBG Memory softkey, [68](#)  
   to Internal Storage softkey, [68](#)  
   troubleshooting, [323](#)  
 Use softkeys  
   As, [67](#)  
   Current Directory As Default Path, [63, 73](#)  
   Only Internal Storage, [63](#)  
   Only USB Media, [63](#)  
 user  
   documentation content, [xiii](#)  
   files, backup and restore, [62](#)  
   flatness correction, [88](#)  
   preset, [42](#)  
   preset, troubleshooting, [323](#)  
 user FIR  
   definition, [333](#)  
 User softkeys  
   Configure Power Meter, [89](#)  
   Current Directory As Default Path, [65](#)  
   Do Cal, [89](#)  
   Flatness, [45, 47, 63](#)  
   Flatness Correction, [89](#)  
   Flatness Corrections, [68](#)  
   Span, [110](#)  
   User, [27](#)  
 user-defined FIR  
   Dual ARB, [210](#)  
 Utility hardkey, [25](#)  
 Utility softkey, [39](#)

**V**

vector operation, [141, 231, 239](#)  
 View Next Error Page softkey, [74](#)

---

# Index

View Previous Error Page softkey, [74](#)  
volatile memory, [142](#), [144](#)  
volatile, definition, [333](#)  
VXI-11, enabling, [32](#)  
VXT-11 SCPI softkey, [32](#)

## W

waveform  
  adding custom modulation, [271](#)  
Waveform 5-Pack  
  history, using, [246](#)  
  history, waveform files, [246](#)  
  installing, [239](#)  
  licensing, [239](#)  
  licensing, understanding, [239](#)  
  licensing, warning messages, [250](#)  
  licensing, waveform file, [240](#)  
  status messages, [242](#)  
  using, [239](#)  
Waveform license, Opt 25x  
  adding a waveform, [233](#)  
  backup warning, [238](#)  
  file missing warning, [238](#)  
  license status messages, [235](#)  
  licensing, installing, [231](#)  
  licensing, understanding, [231](#)  
  licensing, warning messages, [238](#)  
  lock warning, [238](#)  
  replacing a waveform, [233](#)  
  status messages, [235](#)  
  using, [231](#)  
  waveform licensing softkeys, [233](#)  
Waveform softkeys  
  Licenses, [38](#)  
  Runtime Scaling, [190](#)  
  Segments, [144](#)  
  Sequences, [147](#), [171](#)  
  Utilities, [190](#)  
  Waveform, [49](#), [56](#)  
waveforms  
  clipping, [181](#)  
  file headers, [151](#)  
  from digital baseband waveform, [191](#)  
  in a sweep, [58](#)  
  license, [37](#)  
  markers, [157](#), [158](#)  
  memory, [311](#)  
  multiple BBG synchronization, [220](#)  
  multitone, [304–307](#)  
  overview, [142](#)  
  saving instrument state, [70](#)  
  scaling, [190](#)  
  segment softkeys, [144](#)  
  sequence, [147](#)  
  storing, loading, & playing, [144](#)

  triggering, [174](#)  
  two-tone, [298–303](#)  
  Waveform 5-Pack, [246](#)  
Web Server softkey, [32](#)  
wideband AM, [77](#)  
window settings, FIR filter, [216](#), [287](#)  
WINIT annunciator, [12](#), [14](#)

## Y

yellow LED, [8](#), [10](#)

## Z

Z-axis output  
  connector, [23](#)  
Zoom softkeys, [162](#)